

Kanlux



Kanlux
FACTORY

Kanlux OFIS S LED

perfect combination:
effective lighting
with a modern design

Kanlux

OFIS **S** LED



MODERN
AND FASHIONABLE DESIGN



BRANDED COMPONENTS



MADE IN POLAND



SMART

SLIM

SIMPLY



Kanlux

Kanlux OFIS S LED

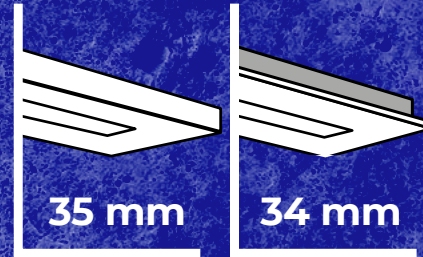

- unique low housing allows for low-rise installation
- fully customizable to the client's and specific needs investments in terms of expected parameters and functionality
- thoughtful solutions facilitating and accelerating assembly

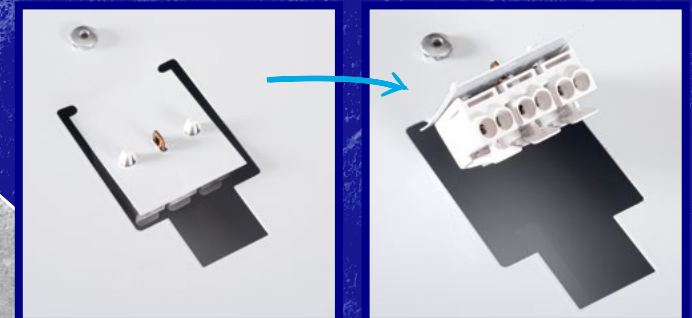

Kanlux

Kanlux OFIS S LED - SPECIAL VERSIONS



emergency version
in eight different
standards with CNBOP
certificate



version with microwave
movement sensor and
possibility connection of the
luminaire unit

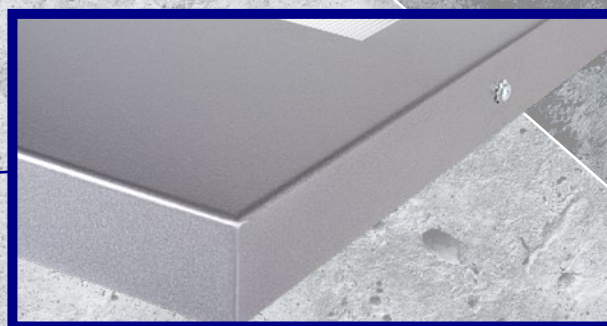

customizable to the most
demanding customers

an example of a painting in the color DB703

3

2

1

Kanlux



Kanlux OFIS S LED

Technical parameters and selected features:

- power supply: **230V**
- power: **40W**
- luminous flux: **4200lm - 4600lm**
- luminous efficiency: up to **115lm/W**
- **5 Year warranty***
- color temperature: **4000K**
- **IP20**
- **high durability L90B10 for 50000h**
- permissible ambient temperature: **5 ÷ 25°C**
- branded components
- installation with the use of quick assemble terminals

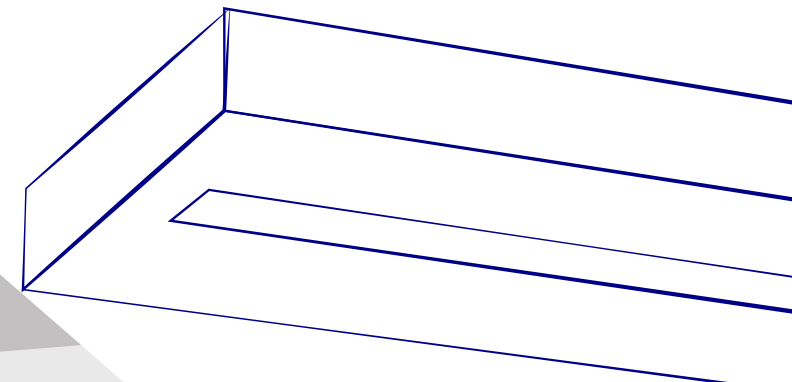

* ACCORDING TO THE TERMS OF THE WARRANTY STATEMENT AVAILABLE ON THE WEBSITE KANLUX.COM

Kanlux

Kanlux OFIS S LED

CODE	NAME	LUMINOUS FLUX
32820	OS 40W-840-MPRM-W-N1	4500lm
32821	OS 40W-840-MPRM-W-N3	4400lm
32824	OS 40W-840-MPRM-B-N1	4200lm
32825	OS 40W-840-MPRM-B-N3	4300lm

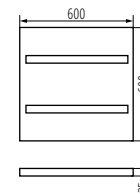

OS 40W-840-MPRM-W-N1
OS 40W-840-MPRM-B-N1



OS 40W-840-MPRM-W-N3
OS 40W-840-MPRM-B-N3

CODE	NAME	LUMINOUS FLUX
32822	OS 40W-840-MPRM-W-P1	4600lm
32823	OS 40W-840-MPRM-W-P3	4500lm
32826	OS 40W-840-MPRM-B-P1	4300lm
32827	OS 40W-840-MPRM-B-P3	4400lm

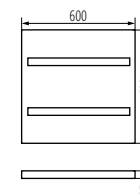

OS 40W-840-MPRM-W-P1
OS 40W-840-MPRM-B-P1

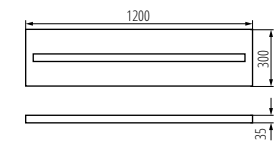

OS 40W-840-MPRM-W-P3
OS 40W-840-MPRM-B-P3

Kanlux

A wide range
of applications:
**offices, shops,
shopping centre,
schools, facilities for
medical purposes,
conference rooms,
corridors.**

