

**GTV**

LIGHTING

**LIGHTING**

P R O D U C T S



CATALOGUE | CATÁLOGO | KATALOG | KATALOG



**GTV**  
LIGHTING

FR

GTV Pologne est un producteur international et l'un des leaders du marché d'éclairage en Pologne. La société propose une gamme complète de produits, allant de sources lumineuses à celles conçues pour des solutions d'éclairage d'investissement spécifiques. Le portefeuille - l'un des plus vastes du marché - comprend des milliers de produits dans plusieurs dizaines de groupes de produits. GTV Pologne est une entreprise moderne avec un management professionnel et, en même temps, un partenaire commercial fiable dans le monde entier.

ES

GTV Poland es un fabricante internacional y una de las compañías líderes en el mercado de la iluminación de Polonia. Ofrece una completa gama de productos: desde las fuentes de iluminación hasta soluciones específicas para proyectos de inversión. Su oferta, una de las más completas del mercado, incluye miles de productos clasificados en decenas de grupos de productos. GTV Poland es una empresa moderna gestionada profesionalmente y socio comercial digno de confianza para distribuidores todo el mundo.

DE

GTV Poland ist ein internationaler Vertreter und eines der führenden Unternehmen auf dem polnischen Beleuchtungsmarkt. Es bietet eine vollständige Produktpalette - angefangen von Lichtquellen bis hin zu spezifischen Beleuchtungslösungen für konkrete Investitionsprojekte. Sein Portfolio - eines der vollständigsten auf dem Markt - umfasst mehrere tausend Produkte in Dutzenden von Produktgruppen. GTV Poland ist ein modernes und professionell geführtes Unternehmen und zugleich ein vertrauenswürdiger Geschäftspartner von Vertragspartnern auf der ganzen Welt.

HR

GTV Poland međunarodni je proizvođač i jedno od vodećih poduzeća u Poljskoj na tržištu rasvjete, koje nudi cijelu paletu proizvoda - od žarulja do konkretnih rasvjetnih rješenja za konkretne projekte. Portfolio naših proizvoda jedan je od najkompletnijih na tržištu - uključuje nekoliko tisuća artikala u nekoliko desetaka grupa proizvoda. GTV Poland moderno je i profesionalno vođeno poduzeće i istodobno pouzdan partner za distributere širom svijeta.



**LAMPES  
FUENTES DE LUZ  
LICHTQUELLEN  
ŽARULJE**

Lampes LED Fuentes de iluminación LED LED-Lichtquellen LED žarulje.....	22
--	----

Tubes LED T8 T8 tubos fluorescentes LED LED-Leuchtröhren vom typ T8 LED cijevi T8.....	60
---	----

**LUMINAIRES INDUSTRIELS  
LUMINARIA TÉCNICA E INDUSTRIAL  
TECHNISCHE UND INDUSTRIELEUCHTEN  
TEHNIČKA I INDUSTRIJSKA RASVJETA**

Lampes LED Paneles y luminarias LED LED-Panele und LED-Leuchten LED paneli i svjetiljke.....	65
---	----

Lampes traditionnelles Luminarias LED industriales LED Industrieleuchten Luminaires Industriels.....	76
---	----

Plafonnier LED Plafones y luminarias para sótanos Decken- und Feuchtraum-/Außenleuchten LED plafonjere i brodske svjetiljke.....	86
---	----

Downlights Luminarias LED tipo downlight Downlight Downlight LED svjetiljk.....	104
--	-----

Projecteurs Proyectores LED LED Flutlichtstarahler LED reflektori.....	126
---	-----

High bay luminaires LED Luminarias LED tipo high bay Highbay led-leuchten High Bay LED svjetiljke.....	132
---	-----

Eclairage public Luminarias LED de para calles y parques Straßen- und Parkleuchten LED LED ulične svjetiljke.....	138
--	-----

Nouzové LED svítidlo Núdzové LED svietidlo Corp de iluminat de EMERGENȚĂ cu LED Vészvilágító LED lámpatest.....	142
--	-----

Luminaires grilles Luminarias con rejilla Rasterleuchten Raster svjetiljke.....	146
--	-----

Luminaires Industriels Luminarias industriales Industrieleuchten Industrijske svjetiljke.....	150
--	-----

Plafonnier LED Plafones y luminarias para sótanos Decken- und Feuchtraum-/Außenleuchten Plafonjere i brodske svjetiljke.....	154
---	-----

Eclairage d'atelier et lampes torches LED Luminarias de taller y linternas LED Werkstattleuchten und LED-Taschenlampen Radioničke i ručne svjetiljke.....	162
--	-----

**ECLAIRAGE DÉCORATIF  
LUMINARIAS DECORATIVAS  
DEKORATIVE FASSUNGEN  
DEKORATIVNA RASVJETA**

Plafonniers Luminarias de techo Deckenleuchten Stropne lampe.....	166
--	-----

Spots		Jeux de barres	
Luminarias para la iluminación por puntos		Barras colectoras	
Punktstrahler		Stromschienen	
Spot svjetiljke.....	220	Sabirnice.....	338
Eclairage mural et jardin		<b>EQUIPEMENT D'INSTALLATION ÉLECTRIQUE</b>	
Luminarias para jardín y fachada		<b>ACCESORIOS PARA INSTALACIONES ELÉCTRICAS</b>	
Garten- und Fassadenleuchten		<b>ELEKTROINSTALLATIONS AUSRÜSTUNG</b>	
Vanjska rasvjeta – vrtne i zidne svjetiljke.....	248	<b>ELEKTROMATERIJAL I PRIBOR.....</b>	<b>352</b>
Lampes de bureau		Equipement d'installation électrique	
Lámparas de escritorio		Accesorios para instalaciones eléctricas	
Schreibtischlampen		Elektroinstallationsausrüstung	
Stolne svjetiljke.....	294	Elektromaterijal i pribor.....	355
<b>SYSTÈME TRACK</b>		<b>ÉCLAIRAGE DE MEUBLES / PROFILS LED</b>	
<b>SISTEMAS DE CARRIL</b>		<b>ILUMINACIÓN PARA MUEBLES / PERFILES LED</b>	
<b>SCHIENENSYSTEME</b>		<b>MÖBELBELEUCHTUNG</b>	
<b>ŠINSKI SUSTAVI.....</b>	<b>314</b>	<b>RASVJETA ZA NAMJEŠTAJ / LED PROFILI.....</b>	<b>398</b>
Systèmes de rail monophasés		Rubans LED / Profils LED	
Sistemas ferroviarios monofásicos		Tiras de LED / Perfiles LED	
1-Phasen-Schienensysteme Reflektori LED		LED-Band / LED-profile	
1-fazni tračnički sustavi Bodové svjetlá LED.....	317	LED trake / LED profili .....	401
Spot LED		Luminaire LED	
Proyectores LED		Luminaria LED	
Spotlights LED		LED-Leuchte	
Reflektori LED.....	318	LED svjetiljke .....	438
Accessoires		Accessoires	
Accesorios		Accesorios	
Zubehör		Zubehör	
Pribor.....	322	Dodatna oprema .....	446
Systèmes de rail triphasés		Rallonge	
Sistemas ferroviarios trifásicos		Alargadera	
3-Phasen-Schienensysteme		Verlängerungskabel	
3-fazni tračnički sustavi .....	325	Utičnice .....	475
Spot LED			
Proyectores LED			
Spotlights LED			
Reflektori LED.....	326		



Lampes  
Fuentes de luz  
Lichtquellen  
Žarulje

					
LD-SMGC30B-30 26	LD-C35FLE4M-30 26	LD-SMDC37-80 26	LD-SMGC30L-30 27	LD-SMC37L-80 27	LD-C35FLE4M-30L 27
					
LD-SMC37L-10 28	LD-SMGB45B-30 28	LD-SMB45B-80 28	LD-G45FLE4M-30 29	LD-SMB45B-10 29	LD-E14S2WE0-40 30
					
LD-E14P35WE-30 30	LD-R5060W-30 30	LD-C35FLE4-30 31	LD-C35FLE4-30L 31	LD-G45FLE4-30 31	LD-C35FP4-18 32
					
LD-C35FP4-18L 32	LD-G45FP4-18 32	LD-PC2A60-8W 33	LD-PC3A60-10W 33	LD-PC2A60-12 33	LD-PC3A60-15W 34
					
LD-PC3A65-18W 34	LD-PC4A65-20W 34	LD-PC2A60-6W 35	LD-A60FLE8M-30 35	LD-R6380W-30 35	LD-PC2A60RGBW 37
					
LD-A60CZ3-10W 37	LD-A60CM3-10W 37	LD-SPCA60-10W 39	LD-DC24A60-12 39	LD-SMGC30C-60 39	LD-SMGB45C-60 41

	 NEW	 NEW	 NEW		 NEW
LD-SMBD45-80 41	LD-G45FLE2EM-30 41	LD-G45FLE2EM-40 42	LD-SMBD45-10 42	LD-120G14W-32 42	LD-ALF100-27W 43
 NEW	 NEW	 NEW	 NEW	 NEW	 NEW
LD-A60FLE8-30 44	LD-G95FLE8-30 44	LD-G125FLE8-30 44	LD-ST64FLE6-30 45	LD-ST64FVE4-30 46	LD-G95FEV4-30 46
 NEW	 NEW	 NEW	 NEW	 NEW	 NEW
LD-G125FEV4-30 46	LD-A60FP8-18 48	LD-G95FP8-18 48	LD-G125FP8-18 48	LD-ST64FP4-18 49	LD-G93WE25-30 50
					 NEW
LD-G93W25-32 50	LD-G9PE35W-30 50	LD-G9P67W0-30 51	LD-G9P95W0-30 51	LD-SPCGU10-7W 51	LD-NGU10P-1W 52
				 NEW	
LD-SZ1510-30 52	LD-PC6010-30 52	LD-SM1210-10 53	LD-SZ5010-30 53	LD-SZ30W10-30 53	LD-J7806WE-40 54
			 NEW	 NEW	 NEW
LD-J7805WCE-40 54	LD-J11810WE-40 54	LD-J11809WCE-40 55	LD-ES111WW13W40-10 56	LD-ES111WW13W40-00 56	LD-AR111WW13W40-10 56
 NEW					
LD-ES111WW11W25A0 57	LD-SM4016-30 57	LD-SM4016-30 57	LD-G4SI115-32 58	LD-G4P30W-30 58	LD-G4018W-30 58



SW-NSZT810W-60 61

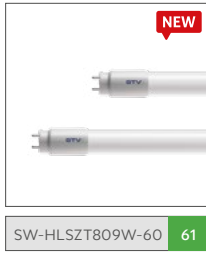

SW-HLSZT809W-60 61



Luminaires industriels  
Luminaria técnica e industrial  
Technische und Industrieleuchten  
Tehnička i industrijska rasvjeta

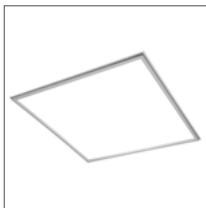

LD-AKO4060-NB 10



LD-SOL36W40-NB 10



LD-MOD4060-NB 68



LD-MOD4060-NB 68

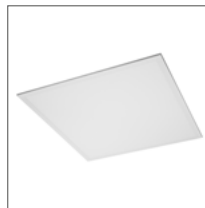

LD-GL40060-NB 69

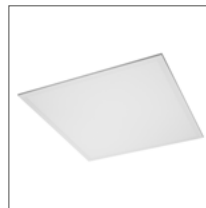

LD-GL40060UGR-NB 70



LD-MA24063-NB 70

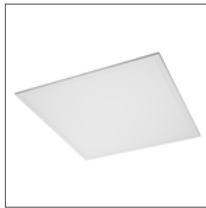

LD-KNG45060-NB 11



LD-ARG30W60-NB 12

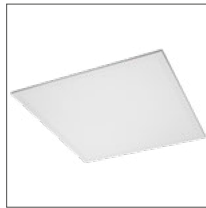

LD-DE40062-NB 73

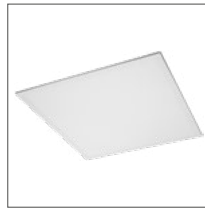

LD-DE40062UGR-NB 12



LK-PANELX4-00 12



ZM-PANELSC-00 12



ZM-PANELSU-00 74



RM-DE625X625-00 13



LD-BERGA50W-30 13



LD-BETISD50W-30 13



LD-LUNAR60-40 13



LD-BESTA40W-30 13



LD-XARO18W-30 13



LD-HR2X18W12-30 14



LD-OMNO60-30B 81



LD-OMN120B-75M 81



LD-LUM120-30P 82



LD-HER60W12-NB 82

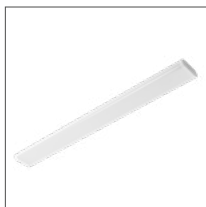

LD-LNG24WB-NB 10



LD-ZFPL24W06-NB 83





































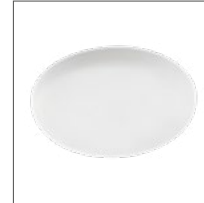
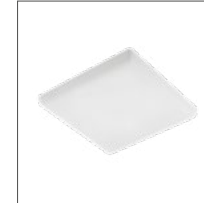

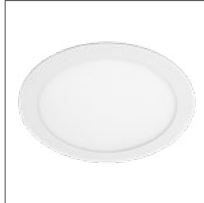
LD-OLL20W-CB 84

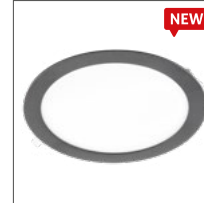
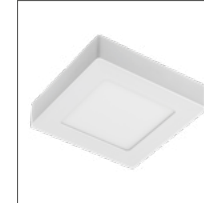



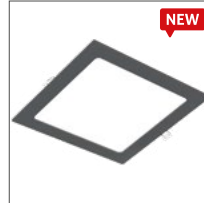















LD-ONT120-36 84



LD-ONTEND-00 85

		 NEW			 NEW
LD-BES24WOK-30 87	LD-BES24WKW-30 87	LD-STARS24W-NB 88	LD-MOON12W-NB 88	LD-FEN20W-NW-00 90	LD-SATU12W-NW-00 90
	 NEW				
LD-SATU12WM-NB 91	LD-ATOL32W-NW-10 91	LD-TOK22W-40 92	LD-TOK16WP-40 92	LD-TOK16WD-40 93	LD-OSA16WD-40 93
 NEW	 NEW	 NEW			
LD-ASTID13-NW-00 95	LD-ASTR12W-NW-00 95	LD-ASTR12WM-NW 96	LD-LOG16W-LED 96	LD-MCR12W-NB 97	OS-ITL12W-LED 98
					
OS-ITL12WKW-LED 98	LD-KALU10OK-40 99	LD-KALU10OW-40 99	LD-TWI10WOK-40 100	LD-TWI10WOW-40 100	LD-DELOR6WC-NB 102
					
LD-DELOW6WC-NB 102	LD-KD08WOV-NB 103	LD-KD08WOK-NB 103	LD-SRW12WOK-NB 105	LD-SRW12WKW-NB 105	LD-ORN07W-CBP 106
 NEW			 NEW		
LD-ORN07W-CBP-10 106	LD-ORW03W-CBP 107	LD-ORW03W-NBP4 107	LD-ORW07W-CBP-10 108	LD-MAN07W-CBP 108	LD-MAW03W-CBP 109
	 NEW	 NEW			
LD-MAW03W-CBP4 109	LD-MAN07W-CBP-10 110	LD-MAW07W-CBP-10 110	LD-MZ12WOK-NB 111	LD-MZ12WKW-NB 111	LD-LSNO06W-NB 112



					
LD-LSNK06W-NB 112	LD-LSW003W-NB 114	LD-LSWK03W-NB 114	LD-SMBOK07W-21 115	LD-SMBKW07W-21 115	LD-BLROK18W-61 116
					 NEW
LD-BLRKW18W-61 116	LD-TWN09W-CB 118	LD-TW09W-CB 118	LD-VLROK0538-CB 120	LD-VLRKW0538-CB 120	LD-VLROK0738-CCT 121
 NEW					
LD-VLRKW0738-CCT 121	LD-DNV15W-NB 122	LD-ARZ18W-CCT 122	LD-KAR18W-CCT 124	LD-ARC15W-NB 125	LD-DA200W-40 127
					
LD-VIPERS30W-40 127	LD-INEXT10W-64 128	LD-INEXT30WP-64 128	LD-ILUXC10W-64 130	LD-ILUXC100W-64 130	LD-ALCX10W-64 131
					
LD-OXCX10W-64 131	LD-TK100W-40 133	SO-TK060DE-00 133	LD-HB150W-40 134	RF-HB150W-40 134	LD-KAN150W-NB 136
					
LD-DAL100W-NB 136	LD-PARK3L30W-40 139	SA1 139	LD-IND60W-40 140	LD-STEL080W-40 140	LD-SAHER1-DUO 143
			 NEW		
LD-TERNO1-00 143	OA-SALED1-08 144	LD-CORSO1-00 144	LD-OGLA3W-00 145	LD-OMAH33-00 145	OS-OSL1120S-00 147



OS-OSL2120S-00 147



OS-LE150NJ-01 148



LD-OZE218-00 151



LD-OZE218-01 151



LD-HAG136-30 152



LD-HEL136B-30 152



LD-HAG236KL-ME 153



OS-HERZW1-00 153



OS-PLCRKM-00 155



OS-PLCRKZ-00 155

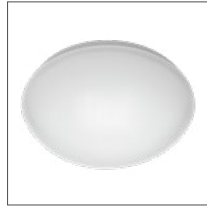

OS-PLCZMI-00 156

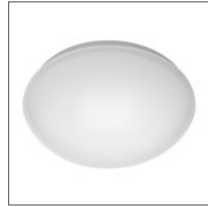

OS-PLCZOO-00 156



OS-IBBL060-00 157



OS-IBKR060-00 157



OS-RINGO1-00 158



OS-KACROO-00 158



OS-KAY060-00 160



OS-KAM060-00 160



OS-KAN527-24 163



OS-KAG508-10 163



LT-LC6WT3-60 163



LT-LK3WBL-60 164



LT-LKSZ3W-60 164



LT-LB6WT2-60 164



LT-LB8WT6-60 165



LT-LB3WT4-60 165



LT-LA8WT2-60 165



Eclairage décoratif  
Luminarias decorativas  
Dekorative Fassungen  
Dekorativna rasvjeta

LD-OME50WNB-10-A 170	LD-OME30WNB-10-L 170	LD-OME30WNB-10-T 170	LK-OMEGA-OP 170	LD-LUN40WNB-10-A 172	RM-LUNA120-10 172
LD-LIV40WNB-10 173	LD-VIL42WUDB-NB 173	LD-FRT36WB-NB 174	LD-JAS15W-40 174	LD-ZIT600W-01 175	LD-PRM10WB-NB 175
LD-BNC8WKB-NB 176	LD-BNC8WOB-NB 176	LD-BNCC8WOB-NB 178	LD-BNCC8WKB-NB 178	LD-BNCC16WOB2-NB 179	LD-BNC15WKB-NB 180
LD-BNC15WOB-NB 180	LD-SRA08WB-NB 182	LD-SRA18WB-NB 182	LD-ATM15WBP-NB 184	LD-ATM20WBK-NB 184	OS-TENGU10-10 186
OS-TENGU10KW-10 186	OS-AERD20W-10 188	OS-LAG20W-10 189	OS-TRES320W-00 189	OS-AVB8090OK1-10 190	OS-AVB8090KW1-10 190
OS-AVB80160OK2-10 192	OS-AVB80160KW2-10 192	OS-SEN5081OKCZ 194	OS-SEN5091KW 194	OS-SEN5087OKCZ-10 196	OS-SEN5097KW-10 196



OS-SENAQ5087OKB 197

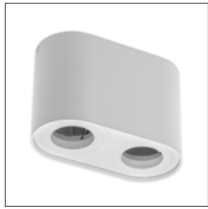

OS-SEND5083OKB 197



OS-RST80125OK1-10 198



OS-RST8080KW1-10 198



OS-ARIQK-11 200



OS-ARIKW-11 200



OS-DRAGO14-10 201



OS-BLND50W1-10 202



OS-BLND50W2-10 203



OS-BLND50W3-10 203



OS-FRG20W2-10 204



OS-FRG20W2-10-MINI 204



OS-SAN20WOK1B-10 205



OS-SAN20WOK2B-10 205



OS-REN20WKW1-10 206



OS-REN20WKW2-10 206



OS-VEN20W01-00 207



OS-VEN20W02-00 207



OS-VEN20W03-00 208



OS-VEN20W04-00 208



OS-VEN20W05-00 209



OS-VEN20WOK4-00 209



OS-ORI-GU10-00 210

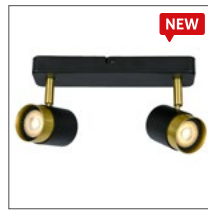

OS-ORI-2GU10-00 210



OS-ORI-3GU10-00 211



OS-LUP-GU10-00 212



OS-LUP-2GU10-00 212



OS-SAKES111-10 213

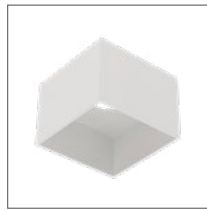

OS-SAKES111KW-10 213



OP-PIREN1-00 214



OP-PIREN2-00 214



OS-ISUES111-10 216

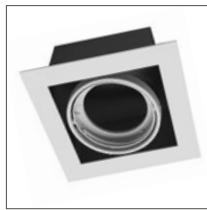

OP-PIREO1-20 217

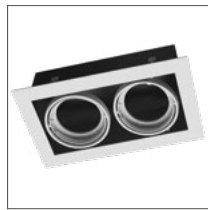

OP-PIREO2-20 217



OS-CAMD40WG9OK 218



OS-CAMD40WG9KW 218



OP-PAST1-01 221



OP-PADST3-01 222



OP-PADRK3-01 223

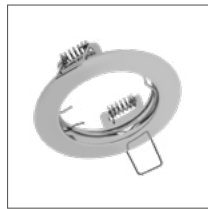



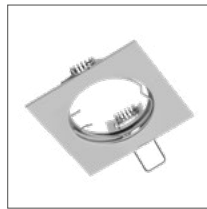















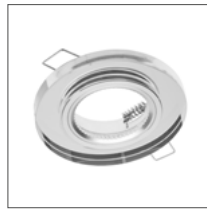
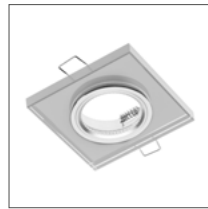
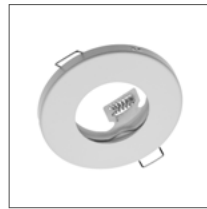









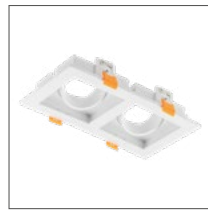







OP-PROD3-01 224



OP-PROD4-01 225

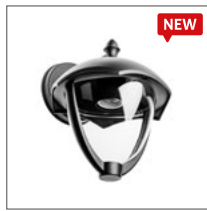
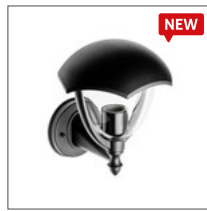

OP-PRAN5-01 226

					 <b>NEW</b>
OP-PRAN6-01 227	OP-OPROKR-21 228	OP-OPRKWT-21 228	OP-OPRKW1-80 229	OP-OPROK1-80 229	OP-CANOKB-10 230
 <b>NEW</b>					
OP-CANKWB-10 230	OP-SALOK-10 231	OP-SALKW-10 231	OP-PALACEDOK-10 232	OP-PALACEDKW-10 232	OP-MAROK-10 234
 <b>NEW</b>	 <b>NEW</b>				
OP-ARIOK-11 235	OP-ARIKW-11 235	OP-AUROKB-10 236	OP-AURKWB-10 236	OP-LINTOK-10 238	OP-KERLKW-10 238
					
OP-ELVAOBB-10 239	OP-ALSOK-10 240	OP-ALSKW-10 240	OP-RUBIOKW1-10 242	OP-RUBIOKW2-10 242	LD-ESOA084-51 244
			 <b>NEW</b>		
LD-ESOB084-51 244	LD-ESKA084-51 246	LD-ESKB084-51 246	LD-KAT400-01 247	OS-MILA00A-00 249	OS-MILA10P-00 249
 <b>NEW</b>			 <b>NEW</b>	 <b>NEW</b>	 <b>NEW</b>
OS-CORP40-30 250	OS-KERTP40-30 252	OS-KEMIOUA-30 254	OS-MEDOAU-30 256	OS-LARGOUA-30 258	OS-TORP50-00 260
		 <b>NEW</b>	 <b>NEW</b>	 <b>NEW</b>	
OS-USTIP40-30 261	OS-USTI0UD-30 261	OS-GRA0DA-00 262	OS-GRA0UA-00 262	OS-GRA00P-00 262	OS-MARINADA-00 264





OS-MARINAUA-00 264



OS-MARINAH-00 264



OS-MARINAP-00 264



OS-TOSODA-80 266



OS-ASTRITE27-80 266



OS-ESOE2711-80 268



OS-VENTANAH-00 268



OS-LEN100OKG-30 270



OS-LEN100KWG-30 270



OS-RIV102KWG-30 271



OS-RIV102OKG-30 271

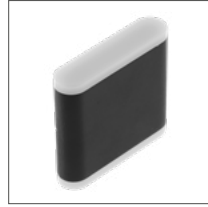

LD-VALLA8W-40 272



LD-MISS7WOC-NB 273



LD-MISS7WKC-NB 273

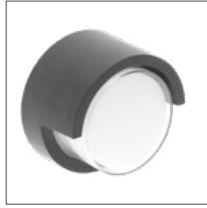

LD-CANTI12WOK-40 274



LD-CANTI12WKW-40 274



LD-PAR10W40BC-00 276



LD-PAR10W40-00 276



LD-NESSAGU10J-80 278



LD-NESSAGU10D-80 278



LD-SILVAGU10J-80 280



LD-SILVAGU10D-80 280



LD-TIAGOGU10J 282



LD-TIAGOGU10D 282

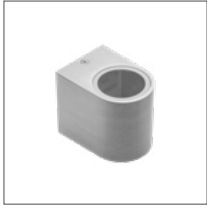

LD-TIAGOGU10J-01 284

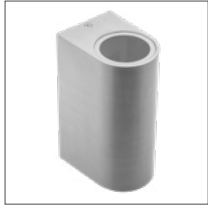

LD-TIAGOGU10D-01 284



LD-BALGU10-00 285



LD-BA2E27-00 285

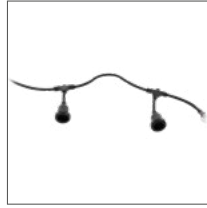

AE-GR610-10 286



AE-GIR10-10 287



OS-DIEGOGU10-80 288



OS-MARMO25-00 289



OS-GRAZIEGU10-20 290



ON-ALFAOGU10-06 292



ON-ALFAOGU10 MINI 291



ON-BETAOGU10RK-06 292



ON-ALFAO-C1W 292



LB-GAL3WRU-10 295



LB-GAL5WRU-10 295



LB-HAL8W-00-DEC 296



LB-FRO5W-00-DEC 296



LB-FLOW4W-06-DEC 298





LB-HIK6WCCT-00 298 LB-IZK6WCCT-00 299 LB-GAL5WM0-10 300 LB-LIN7W-00-DEC 300 LB-GAL8W-00-DEC 302 LB-TRIT6W-00-DEC 303



LB-BRE8W-11-DEC 304 LB-HEL6W-25-DEC 304 LB-LON12W-10-DEC 306 LB-MON3W-40-DEC 306 LB-ARCH8W-00 307 LB-VEN20WO-00 307



LP-VAS8W-10-DEC 308 LP-YORK10W-00-DEC 310 LP-BENFICA2-80 312 LP-VEN20WO-00 313



Système track  
Sistemas de carril  
Schienensysteme  
Šinski sustavi



XLT-ORI-GU10-00 318 XLT-Z3OP20SZ1B-10 318 XLT-ADOGU10-00 319 XLT-ETNAES111-00 319 XLD-LMAGU10KB-NB 320 XLD-LMAGU10OB-NB 320



XLD-GRSGU10KB-NB 321 XLD-GRSGU10OB-NB 321 XLT-1FAC67-10 322 XLD-LMAGU10OB-NB 326 XLD-LMAGU10KB-NB 326 XLD-GRSGU10OB-NE 328

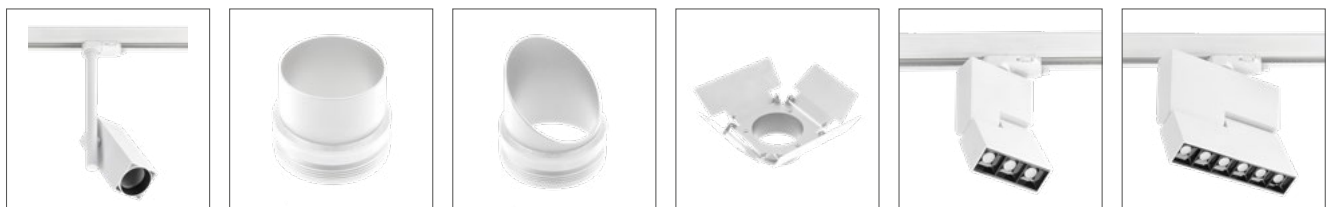

XLD-GRSGU10KB-NB 328 XLD-LKSWLGAB-00 330 XLD-LKSWLGGB-00 330 XLD-LKSWLGCB-00 330 XLD-SRA08WB-NB 332 XLD-SRA18WB-NB 332



TLD-12W38LN-NBO 334



XLD-1524XLN-NBO 336

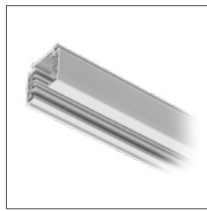

XTR-RA3FZ1B-00 339

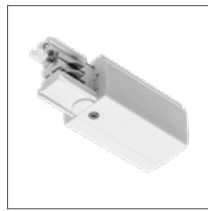

XAE-KZASPB-00 339

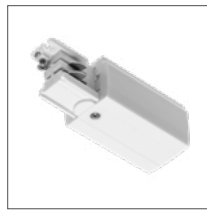

XAE-KZASLB-00 339

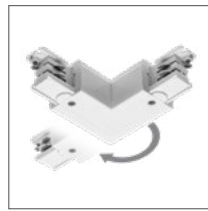

XAE-LKLRZWB-00 340

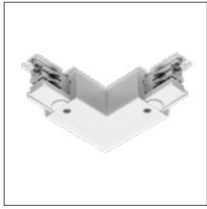

XAE-LKLLZB-00 340

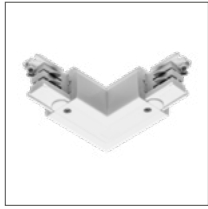

XAE-LKLPWB-00 340

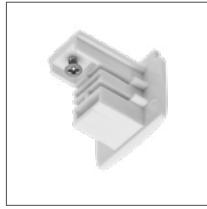

XAE-ZKUNCB-00 341



XAE-LKELB-00 341

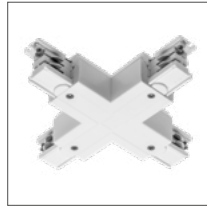

XAE-LKXUB-00 341

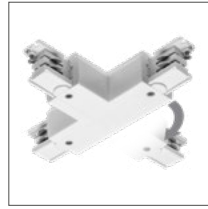

XAE-LKTRZWLb-00 342

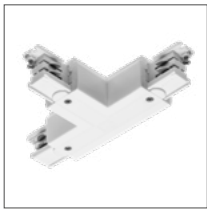

XAE-LKTWLB-00 342

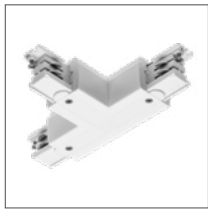

XAE-LKTZLB-00 342

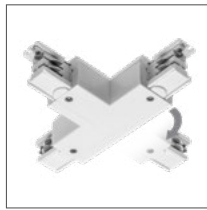

XAE-LKTRZWPB-00 343

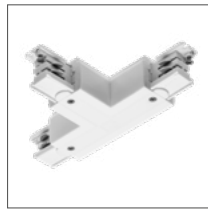

XAE-LKTWPB-00 343

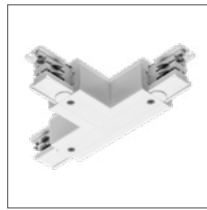

XAE-LKTZPB-00 343

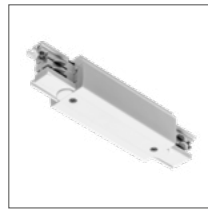

XAE-LELZB-00 344



XAE-LKRUB-00 344



XAE-LELUB-00 344

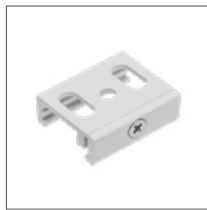

XAE-MSUNB-00 345



XAE-ZZWECLB-00 345



XAE-ZZWL120B-00 345



XAE-LMIZB-00 346

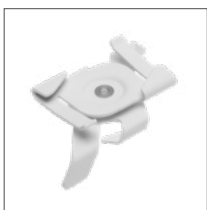

XAE-MSEZB-00 346

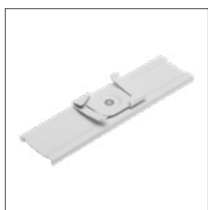

XAE-MS120B-00 346



XAE-BNADB-00 347



XAE-HMKB-00 347



XAE-GNSCH-00 347



Equipement d'installation électrique  
Accesorios para instalaciones eléctricas  
Elektroinstallationsausrüstung  
Elektromaterijal i pribor

CR-CR1000-10 360	CR-CR2000-10 360	CR-CR3000-10 361	CR-CR3M00-10 361	CR-CR4L00-00 362	CR-CR5000-00 362
CR-CR5M00-00 363	CR-CR6000-00 363	CR-CR7000-00 364	CR-CR8000-00 364	CR-CR9000-10 365	CR-CR9M00-10 365
CR-CO1000-00 366	CR-CO2000-00 366	CR-CR1100-00 367	CR-CR1200-00 367	CR-CR13000-00 368	CR-CR1400-00 368
CR-CR15000-00 369	CR-CR16000-00 369	CR-CR17000-00 370	CR-CR18000-00 370	CR-CR19000-00 371	AE-CM1000-00 371
AE-CM3000-00 372	AE-CM3M00-00 372	AE-CM4000-00 373	AE-CM5000-00 373	AE-CM6000-00 374	AE-CM9000-10 375
AE-CM1500-00 375	AE-SRC812-MIN 376	AE-SRC812-MIN2 376	AE-SRC812-00 377	CZ-CZ1000-00 377	CZ-CZ2000-00 378



PC-MECH24-00 379



PC-ELE724-00 379



AE-PS3G3M-00 380



AE-PF3G1M-00 380



AE-SBEBEN-30 381



AE-PFBEBEN-20 381



AE-POGRODUN-10 382



GZ-GZ10-0000 382

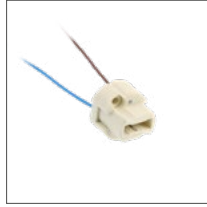

GZ-G90000-00 383



AE-RU0121-00 383



AE-RU0102-00 383



AE-SC0102-00 384



AE-SC0103-00 384



AE-VA1UNI-00 384



AE-RU0103-00 385



AE-OCEF27-00 385



AE-OCEE14-00 385



AE-OCEE27-00 386



AE-OCEE27-MM 386



AE-OCEE40-00 386



AE-OPE27P-00 387



GZ-E27000-10 387



AE-E14GU10-00 387



AE-E14E27-00 388



AE-E27E14-00 388



AE-27GU10-00 388



AE-GU10E27-00 389



AE-E40E27-00 389



AE-E27RING-10 389



WZL-2 390



WZL-3 390



WZL-4 390



LZ-KOI2KO-10 391

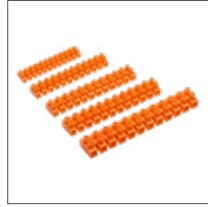

LZ-25MM00-00 391



AE-MA8025-10 392

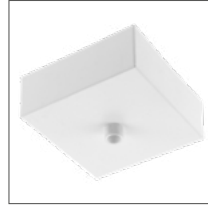

AE-MAS80X80-10 392

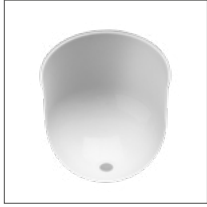

AE-CANOPY-10 393



OH-ST2500-23 393



LD-KABE2M-00 394



KB-W310HUG-20 394



OS-Sta422-00 394



OS-SEL236-ZHQ 395



OS-NSEL258-00 395



BK-PUL030A-0700AD 396



BK-BHL050-1000BZ 396

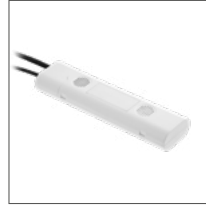

OA-MALEDPAN-00 397



Éclairage de meubles / profils led  
Iluminación para muebles / perfiles led  
Möbelbeleuchtung  
Rasvjeta za namještaj / led profili



LD-3528-300-20-ZB 404



LD-3528-300-20-ZB 406



LD-2835-24V-300-20 407



LD-ZL5RGB150-00 407



LD-COB12V-20-ZB 408



LD-COB24V-20-ZBN 408



LD-NF12V6x12-65 409



PA-GLAXGKL3M-00C 410



PA-GLAXGKS3M-00C 412



PA-GLAXGKW3M 414



PA-GLAXGKWK3M 416



PA-GLAXGKZK3M 417

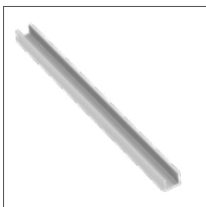

PA-GLAXMICNK-AL 418



PA-GLAXMNK-AL 420



PA-GLAXNK-AL 421



PA-GLAXMNKW-AL 422

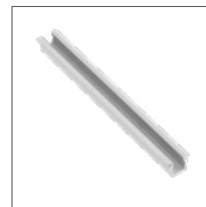

PA-GLAXMIC-AL 423



PA-GLAX-AL 424



PA-GLAXMW-AL 425



PA-GLAXDR-AL 426

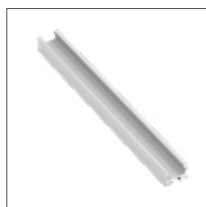

PA-GLAXRAD-AL 427



PA-GLAXWN-AL 428



















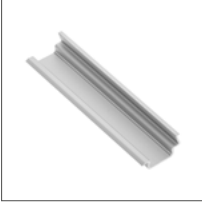

















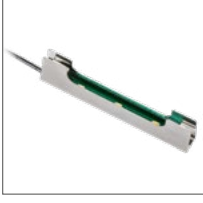





PA-GLAXNKKT-AL 429



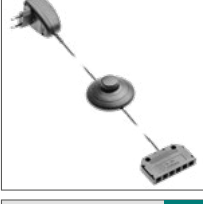

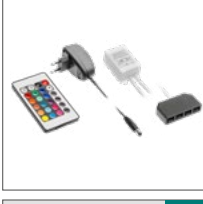
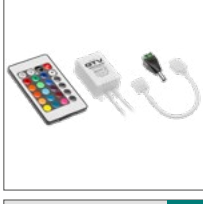































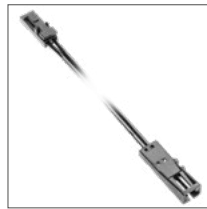
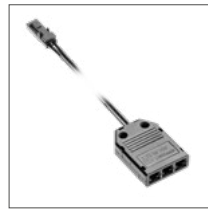

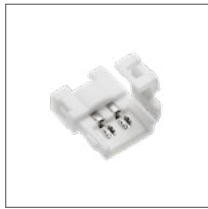

PA-GLAXMNBW3M 430

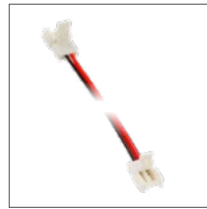

					
PA-GLAXMNBW3M16 430	PA-GLAXMPK-AL 431	PA-GLAXREGI-AL 431	PA-GLAXNBW2M16 432	PA-GLAXNBW3M16 432	PA-GLAXNBD3M16 433
					
PA-GLAXNBDW3M16 433	PA-GLAXKT-AL 434	PA-GLAXWPKT-AL 434	PA-ZGLAXOMZ-00 435	PA-ZGLAXMNMOMZ 435	PA-ZGLAXKTOMZ 436
					
PA-ZGLAXKTOMZ 436	LD-VA24CB-53 439	LD-LU16CB-53 439	LD-CS36CB-53 440	LD-AL24CB-53 440	LD-VE15CB-53N 441
					
LD-VE15CBZB-53N 441	LD-TR24CB-53 442	LD-Z3CSCB-53 442	LD-OBP27CB-53 443	LD-KWP27CB-53 443	LD-RA60CB-40N 444
					
LD-IRUSB-53 444	LD-BOS1CBWG-53 445	LD-KLPCB-00N 445	LD-3SKL-CBN 445	LD-ZAS09WEC-30 447	LD-ZAS75W-30 448
					
LD-ZAS24PRO80W-30 448	LD-ZZAS07PROKD6 449	LD-ZASPRO07W-30 449	LD-ZAS150-NW 450	LD-ZAS350-NW 450	LD-WZA20W-NW 451
					
LD-ZASPU15W-30N 451	LD-ZSKL15-00N 452	LD-ZWND6W-10 452	LD-ZAC6WDE-RGB 453	LD-KONMINI-RGB 453	LD-KONML-MONO 454

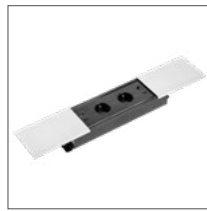

					
LD-KONML-MONO-PIL 454	LD-KONML-MONO-PAN 454	LD-KONML-RGBW 455	LD-KONML-RGBW-PIL 455	LD-KONML-WRGB-PAN 455	LD-KONML-WIFI 456
					
LD-KONML-AD 456	AE-WDBP1-10 458	AE-WDBP2CCT-10 458	AE-WBEZDC-10S 460	AE-WBEZDK15-10 460	AE-WBEZDPIR-10 461
					
AE-WBEZDPIR2-20 461	AE-WBBUNI-10DIM 462	AE-WBE1-20 462	AE-WBE2-20 463	AE-WDSB-10DIM 463	AE-WBEZD-NBN 464
					
AE-WPDRW-00 464	AE-WLPR-60 465	AE-WLB01-10 465	AE-WLIP44-15 466	LD-DIMLED-10 466	AE-WLLAN1-10 467
					
AE-WLSZN1-10 467	LD-KABE2M-00 468	LZ-KA2MM-10 468	LZ-KAPR2M-10 469	LZ-AKZ312-10N 469	LZ-AKZ612-10N 470
					
LD-ZTK8-COB 470	LD-ZTL8MM-02N600 471	LD-ZTK8MM-02N 471	LD-ZTK8MM-02N 472	LD-ZTLS8MMAMP-02N 472	LD-ZTKS8MM-02N 472
					
AE-ZLADLUX-40 473	AE-ZLADPOD-20 473	AE-ZUSB-20 474	AE-PB2FPRES-20 476	AE-BPW1FACP-10 478	AE-BPW4F120P-10 480



AE-BPW2FCAM-20 482



AE-PB1FAVAP-20 484



AE-PB1FAVA-20 486



AE-BPW1S2UCH-80 488



AE-BPW1U1UCH-53 488



AE-BPW1U1UCH-51 489



AE-BPW4U100-53 489



AE-BPW3GU-20 490



AE-BPW3U60-20 490



AE-PB03GS-53 491



AE-PBU02GS-10 491



AE-PBSC3GS-10 492



AE-PBC3GS-53BKS 494



AE-PBC3GS-51BK 494



AE-PBKT4U-80 495



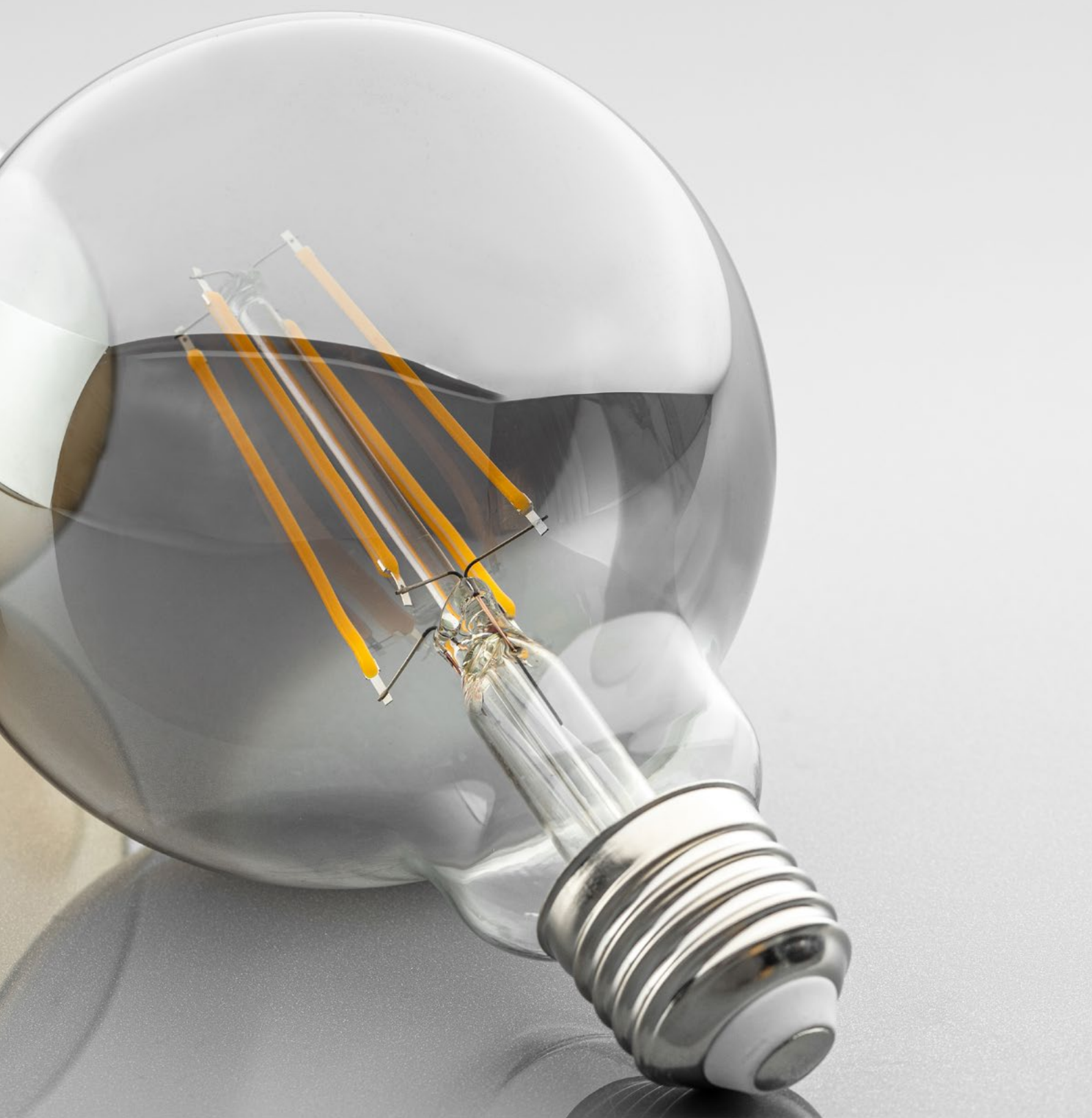

LAMPES  
FUENTES DE LUZ  
LICHTQUELLEN  
ŽARULJE



Lampes LED	
Fuentes de iluminación LED	
LED-Lichtquellen	
LED žarulje .....	25
Tubes LED T8	
T8 tubos fluorescentes LED	
LED-Leuchtröhren vom Typ T8	
LED cijevi T8 .....	60





LAMPES LED  
FUENTES DE ILUMINACIÓN LED  
LED-LICHTQUELLEN  
LED ŽARULJE



FR Source de lumière LED  
 ES Fuente de iluminación LED  
 DE LED-Leuchtmittel  
 HR LED žarulje

## C30

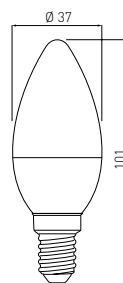
**NEW**
**LED**  
TECHNOLOGY

**3**  
years  
warranty

**E14**
**3-6 W**

LD-SMGC30B-30	3,0 W	3,0 W = 26 W	F	33 mA	● 3000 K	260 lm	PF > 0,4	32 g	5901867120014
LD-SMNGC30B-30					● 4000 K				5902801235139
LD-SMZGC30B-30					● 6400 K				5902801414725
LD-SMGC30B-60*	6,0 W	6,0 W = 43 W		52 mA	● 3000 K	520 lm	PF > 0,5		5901867171948
LD-SMNGC30B-60*					● 4000 K				5902801235344
LD-SMZGC30B-60*					● 6400 K				5902801423765



FR Source de lumière LED  
 ES Fuente de iluminación LED  
 DE LED-Leuchtmittel  
 HR LED žarulje

## C35

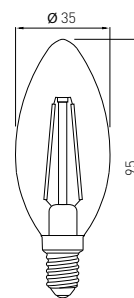
**NEW**
**LED**  
TECHNOLOGY

**3**  
years  
warranty

**E14**
**4 W**

LD-C35FLE4M-30	4,0 W	4,0 W = 37 W	F	44 mA	● 3000 K	420 lm	30 g	5902801339400
LD-C35FLE4M-40				37 mA	● 4000 K			5902801358326



FR Source de lumière LED  
 ES Fuente de iluminación LED  
 DE LED-Leuchtmittel  
 HR LED žarulje

## C37

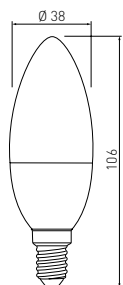
**NEW**
**LED**  
TECHNOLOGY

**3**  
years  
warranty

**E14**
**8 W**

LD-SMDC37-80	8,0 W	8,0 W = 55 W	F	70 mA	● 3000 K	720 lm	30 g	5902801028373
LD-SMNDC37-80					● 4000 K			5902801298967
LD-SMZDC37-80					● 6400 K			5902801424243



FR Source de lumière LED  
ES Fuente de iluminación LED  
DE LED-Leuchtmittel  
HR LED žarulje

### C30L

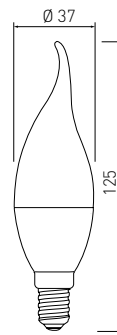

**NEW**

3 years warranty

LED  
E14  
6 W



LD-SMGC30L-30	3,0 W	3,0 W = 26 W	F	33 mA	3000 K	260 lm	35 g	5902801423529
LD-SMNGC30L-30					4000 K			5902801423550
LD-SMZGC30L-30					6400 K			5902801423604
LD-SMGC30L-60	6,0 W	6,0 W = 43 W		52 mA	3000 K	520 lm		5901867120359
LD-SMNGC30L-60					4000 K			5902801235016
LD-SMZGC30L-60					6400 K			5902801423826



FR Source de lumière LED  
ES Fuente de iluminación LED  
DE LED-Leuchtmittel  
HR LED žarulje

### C37L

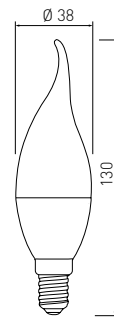

3 years warranty

LED  
E14  
8 W



LD-SMC37L-80	8,0 W	8,0 W = 55 W	F	70 mA	3000 K	720 lm	30 g	5902801028380
LD-SMNC37L-80					4000 K			5902801298899
LD-SMZC37L-80					6400 K			5902801425028



FR Source de lumière LED  
ES Fuente de iluminación LED  
DE LED-Leuchtmittel  
HR LED žarulje

### C35L

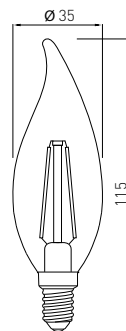

**NEW**

3 years warranty

LED  
E14  
4 W



LD-C35FLE4M-30L	4,0 W	4,0 W = 37 W	F	44 mA	3000 K	420 lm	30 g	5902801339424
LD-C35FLE4M-40L					4000 K			420 lm





FR Source de lumière LED  
ES Fuente de iluminación LED  
DE LED-Leuchtmittel  
HR LED žarulje

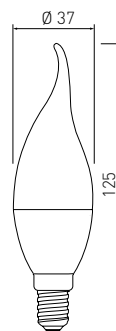

NEW

LED  
TECHNOLOGY3  
years  
warranty

E14

8 W



LD-SMC37L-10	10,0 W	72,0 W	F	1000 lm	3000 K	80mA	62g	46	130,5	5902801362262
LD-SMNC37L-10					4000 K					5902801362606



FR Source de lumière LED  
ES Fuente de iluminación LED  
DE LED-Leuchtmittel  
HR LED žarulje

B45

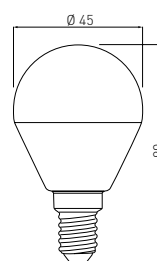

NEW

LED  
TECHNOLOGY3  
years  
warranty

E14

3-6 W



LD-SMGB45B-30	3,0 W	3,0 W = 25 W	F	33 mA	3000 K	225 lm	PF > 0,4	35 g	5901867120410
LD-SMNGB45B-30					4000 K				5902801235481
LD-SMZGB45B-30					6400 K				5902801423642
LD-SMGB45B-60*	6,0 W	6,0 W = 43 W	F	52 mA	3000 K	520 lm	PF > 0,5	35 g	5901867120465
LD-SMNGB45B-60*					4000 K				5902801234941
LD-SMZGB45B-60*					6400 K				5902801423888



FR Source de lumière LED  
ES Fuente de iluminación LED  
DE LED-Leuchtmittel  
HR LED žarulje

B45

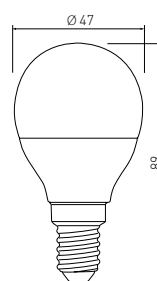

NEW

LED  
TECHNOLOGY3  
years  
warranty

E14

8 W



LD-SMB45B-80	8,0 W	8,0 W = 55 W	F	70 mA	3000 K	720 lm	30 g	5902801028397
LD-SMNB45B-80					4000 K			5902801298929
LD-SMZBD45-80					6400 K			5902801476921



FR Source de lumière LED  
 ES Fuente de iluminación LED  
 DE LED-Leuchtmittel  
 HR LED žarulje

**G45**

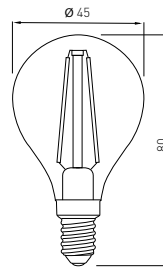

**NEW**

**3**  
years  
warranty

**LED**  
technology...  
**E14**  
**4 W**

LD-G45FLE4M-30	4,0 W	4,0 W = 37 W	F	44 mA	● 3000 K	420 lm	30 g	5902801339301
LD-G45FLE4M-40					● 4000 K			5902801358098



FR Source de lumière LED  
 ES Fuente de iluminación LED  
 DE LED-Leuchtmittel  
 HR LED žarulje

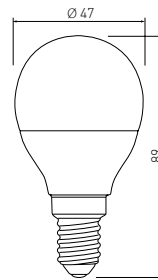

**NEW**

**3**  
years  
warranty

**LED**  
technology...  
**E14**  
**10 W**

LD-SMB45B-10	10,0 W	10,0 W = 72 W	F	80 mA	● 3000 K	1000 lm	69 g	5902801362378
LD-SMNB45B-10					● 4000 K			5902801362590





FR Source de lumière LED  
 ES Fuente de iluminación LED  
 DE LED-Leuchtmittel  
 HR LED žarulje

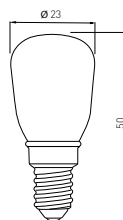

LED



E14

2 W

LD-E14S2WE0-40	2,0 W	2,0 W = 19 W	F	22 mA	4000 K	180 lm	10 g	5902801328893



FR Source de lumière LED  
 ES Fuente de iluminación LED  
 DE LED-Leuchtmittel  
 HR LED žarulje

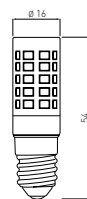

LED



E14

3,5 W

LD-E14P35WE-30	3,5 W	3,5 W = 32 W	F	38 mA	3000 K	350 lm	12 g	5902801330681



FR Source de lumière LED  
 ES Fuente de iluminación LED  
 DE LED-Leuchtmittel  
 HR LED žarulje

R50

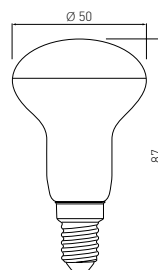

LED



E14

6 W

LD-R5060W-30	6,0 W	6,0 W = 43 W	F	52 mA	3000 K	520 lm	28 g	5901867113467
LD-R5060W-40		6,0 W = 42 W			4000 K	500 lm		5902801215872





FR Source de lumière LED  
 ES Fuente de iluminación LED  
 DE LED-Leuchtmittel  
 HR LED žarulje

**C35**

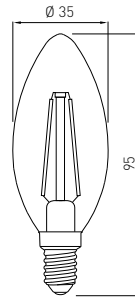

**NEW**

**3**  
years  
warranty

**LED**  
LIGHTING

**E14**  
4 W



LD-C35FLE4-30	4,0 W	4,0 W = 37 W	F	44 mA	● 3000 K	420 lm	30 g	5902801328831
LD-C35FLE4-40					● 4000 K			5902801339325



FR Source de lumière LED  
 ES Fuente de iluminación LED  
 DE LED-Leuchtmittel  
 HR LED žarulje

**C35L**

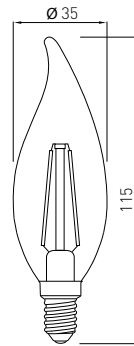

**NEW**

**3**  
years  
warranty

**LED**  
LIGHTING

**E14**  
4 W



LD-C35FLE4-30L	4,0 W	4,0 W = 37 W	F	44 mA	● 3000 K	420 lm	30 g	5902801328268
LD-C35FLE4-40L					● 4000 K			5902801339448



FR Source de lumière LED  
 ES Fuente de iluminación LED  
 DE LED-Leuchtmittel  
 HR LED žarulje

**G45**

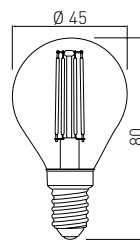

**NEW**

**3**  
years  
warranty

**LED**  
LIGHTING

**E14**  
4 W



LD-G45FLE4-30	4,0 W	4,0 W = 37 W	F	44 mA	● 3000 K	420 lm	30 g	5902801328435
LD-G45FLE4-40					● 4000 K			5902801356933





FR Source de lumière LED  
ES Fuente de iluminación LED  
DE LED-Leuchtmittel  
HR LED žarulje

## C35

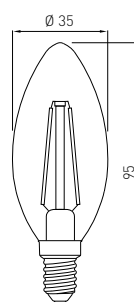

NEW

LED  
TECHNOLOGY3  
years  
warrantyE14  
4 W

LD-C35FP4-18	4,0 W	4,0 W = 21 W	-	44 mA	1800 K	200 lm	30 g	5902801393228
LD-C35FEP4-30		4,0 W = 28 W	G		2700 K	300 lm		5902801359071



FR Source de lumière LED  
ES Fuente de iluminación LED  
DE LED-Leuchtmittel  
HR LED žarulje

## C35L

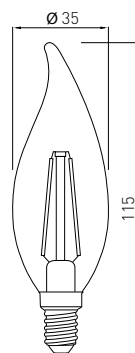

NEW

LED  
TECHNOLOGY3  
years  
warrantyE14  
4 W

LD-C35FP4-18L	4,0 W	4,0 W = 21 W	-	44 mA	1800 K	200 lm	30 g	5902801397707
LD-C35FEP4-30L		4,0 W = 28 W	G		2700 K	300 lm		5902801359217



FR Source de lumière LED  
ES Fuente de iluminación LED  
DE LED-Leuchtmittel  
HR LED žarulje

## G45

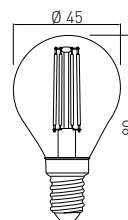

NEW

LED  
TECHNOLOGY3  
years  
warrantyE14  
4 W

LD-G45FP4-18	4,0 W	4,0 W = 21 W	-	44 mA	1800 K	200 lm	30 g	5902801393464
LD-G45FPE4-30		4,0 W = 28 W	G		2700 K	300 lm		5902801358500



FR Source de lumière LED  
ES Fuente de iluminación LED  
DE LED-Leuchtmittel  
HR LED žarulje

A60

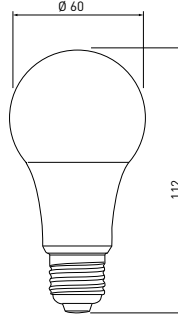

LD-PC2A60-8W	8,0 W	8,0 W = 55 W	F	70 mA	3000 K	720 lm	40 g	5902801216305
LD-PN2A60-8W					4000 K			5902801216312



FR Source de lumière LED  
ES Fuente de iluminación LED  
DE LED-Leuchtmittel  
HR LED žarulje

A60

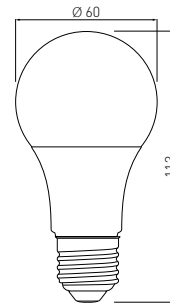

LD-PC3A60-10W	9,5 W	9,5 W = 66 W	F	83 mA	3000 K	900 lm	40 g	5901867153302
LD-PN3A60-10W					4000 K			5902801000508
LD-PZ3A60-10W					6400 K			5902801269639



FR Source de lumière LED  
ES Fuente de iluminación LED  
DE LED-Leuchtmittel  
HR LED žarulje

A60

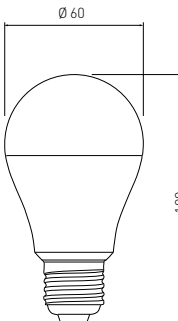

LD-PC2A60-12	11,5 W	11,5 W = 77 W	F	100 mA	3000 K	1100 lm	45 g	5901867131621
LD-PN2A60-12					4000 K			5902801000539
LD-PZ2A60-12					6400 K			5902801269646



FR Source de lumière LED  
 ES Fuente de iluminación LED  
 DE LED-Leuchtmittel  
 HR LED žarulje

A60

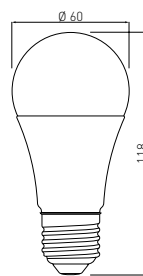

LED



14 W



LD-PC3A60-15W	14,1 W	14,1 W = 94 W	F	123 mA	3000 K	1400 lm	45 g	5901867124838
LD-PN3A60-15W					4000 K			5902801000560
LD-PZ3A60-15W					6400 K			5902801341885



FR Source de lumière LED  
 ES Fuente de iluminación LED  
 DE LED-Leuchtmittel  
 HR LED žarulje

A60

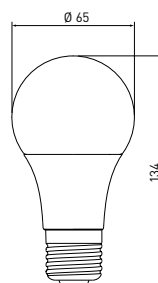

LED



17 W



LD-PC3A65-18W	17,3 W	17,3 W = 112 W	F	150 mA	3000 K	1750 lm	54 g	5902801233951
LD-PN3A65-18W					4000 K			5902801234187
LD-PZ3A65-18W					6400 K			5902801340055



FR Source de lumière LED  
 ES Fuente de iluminación LED  
 DE LED-Leuchtmittel  
 HR LED žarulje

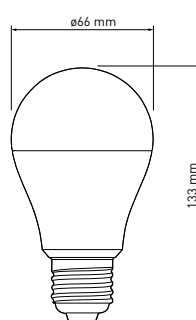

LED



20 W



LD-PC4A65-20W	20,0 W	20,0 W = 148 W	E	164 mA	3000 K	2400 lm	PF > 0,5	65 g	5902801398667
LD-PN4A65-20W					4000 K				5902801398681
LD-PZ4A65-20W					6500 K				5902801398414



FR Source de lumière LED  
 ES Fuente de iluminación LED  
 DE LED-Leuchtmittel  
 HR LED žarulje

**A60**

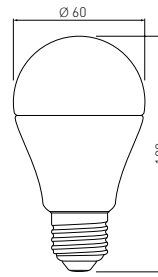

**LED**  
LIGHTING

**E27**

**6 W**

LD-PC2A60-6W	6,0 W	6,0 W = 43 W	F	52 mA	3000 K	520 lm	60 g	5901867118745

180-250 V 50-60 Hz, PF>0,5, CRI ≥80, 240°, 40 000h, ON/OFF x10000, <0,1s, Hg 0,0mg, EAC, CE, UKCA,

FR Source de lumière LED  
 ES Fuente de iluminación LED  
 DE LED-Leuchtmittel  
 HR LED žarulje

**A60**

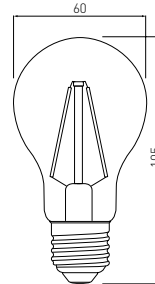

**LED**  
LIGHTING

**E27**

**8 W**

LD-A60FLE8M-30	8,0 W	8,0 W = 60 W	F	70 mA	3000 K	800 lm	60 g	5902801339332
LD-A60FLE8M-40					4000 K			5902801351006

220-240 V 50-60 Hz, PF>0,5, CRI ≥80, 360°, 40 000h, ON/OFF x10000, <0,1s, Hg 0,0mg, EAC, CE, UKCA,

FR Source de lumière LED  
 ES Fuente de iluminación LED  
 DE LED-Leuchtmittel  
 HR LED žarulje

**R63**

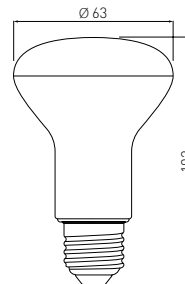

**LED**  
LIGHTING

**E27**

**8 W**

LD-R6380W-30	7,8 W	7,8 W = 54 W	F	68 mA	3000 K	700 lm	51 g	5901867113436
LD-R6380W-40					4000 K			5902801215711

180-250 V 50-60 Hz, PF>0,5, CRI ≥80, 120°, 40 000h, ON/OFF x10000, <0,1s, Hg 0,0mg, EAC, CE, UKCA,







FR Source de lumière LED  
 ES Fuente de iluminación LED  
 DE LED-Leuchtmittel  
 HR LED žarulje

**A60**



LED



10 W

LD-PC2A60RGBW-10W	10,0 W	10,0 W = 60 W	F	87 mA	RGBW	810 lm	135 g	5902801285080

FR Source de lumière LED  
 ES Fuente de iluminación LED  
 DE LED-Leuchtmittel  
 HR LED žarulje

**A60**



LED



9 W

LD-A60CZ3-10W	9,3 W	9,3 W = 61 W	F	81 mA	3000 K	820 lm	40 g	5902801074257
LD-A60CZ4-10W					4000 K			

FR Source de lumière LED  
 ES Fuente de iluminación LED  
 DE LED-Leuchtmittel

HR LED žarulje **A60**



LED



9 W

LD-A60CM3-10W	9,1 W	9,1 W = 61 W	F	79 mA	3000 K	820 lm	40 g	5902801073342
LD-A60CM4-10W					4000 K			





FR Source de lumière LED  
 ES Fuente de iluminación LED  
 DE LED-Leuchtmittel  
 HR LED žarulje

## A60

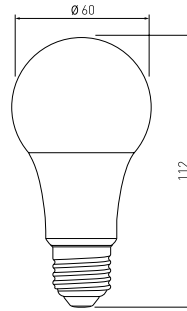

LED



10 W



LD-SPCA60-10W	10,0 W	10,0 W = 68 W	F	87 mA	● 3000 K	940 lm	90 g	5902801294877
LD-SPNA60-10W					● 4000 K			5902801294938



FR Source de lumière LED  
 ES Fuente de iluminación LED  
 DE LED-Leuchtmittel  
 HR LED žarulje

## A60

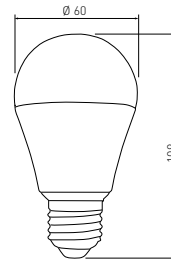

LED



12 W



LD-DC24A60-12	12,0 W	12,0 W = 75 W	G	● 3000 K	1055 lm	50 g	5902801270925
---------------	--------	---------------	---	----------	---------	------	---------------

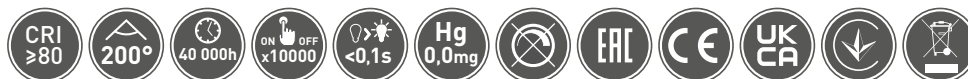

FR Source de lumière LED  
 ES Fuente de iluminación LED  
 DE LED-Leuchtmittel  
 HR LED žarulje

## C30

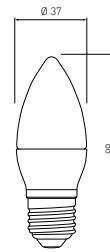

LED



3 - 6 W



LD-SMGC30C-30	3,0 W	3,0 W = 26 W	F	33 mA	● 3000 K	260 lm	35 g	5902801417818
LD-SMNGC30C-30					● 4000 K			5902801416071
LD-SMZGC30C-30					● 6400 K			5902801423185
LD-SMGC30C-60	6,0 W	6,0 W = 43 W		52 mA	● 3000 K	520 lm		5901867120175
LD-SMNGC30C-60					● 4000 K			5902801235061
LD-SMZGC30C-60					● 6400 K			5902801423734





FR Source de lumière LED  
ES Fuente de iluminación LED  
DE LED-Leuchtmittel  
HR LED žarulje

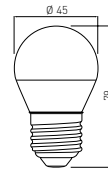

6 W

**B45**



LD-SMGB45C-30	3,0 W	3,0 W = 25 W	F	33 mA	3000 K	255 lm	37 g	5902801423727
LD-SMNGB45C-30					4000 K			5902801423680
LD-SMZGB45C-30					6400 K			5902801423772
LD-SMGB45C-60	6,0 W	6,0 W = 43 W		3000 K	520 lm	5901867120519		
LD-SMNGB45C-60				4000 K		5902801235030		
LD-SMZGB45C-60				6400 K		5902801423895		



FR Source de lumière LED  
ES Fuente de iluminación LED  
DE LED-Leuchtmittel  
HR LED žarulje

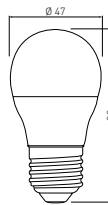

8 W

**B45**



LD-SMBD45-80	8,0 W	8,0 W = 55 W	F	70 mA	3000 K	720 lm	30 g	5902801028403
LD-SMNB45-80					4000 K			5902801298868



FR Source de lumière LED  
ES Fuente de iluminación LED  
DE LED-Leuchtmittel  
HR LED žarulje

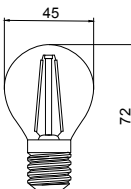

2-4 W

**G45**



LD-G45FLE2EM-30	2,0 W	2,0 W = 21 W	F	22 mA	3000 K	200 lm	13 g	5902801339387
LD-G45FLE4E-30	4,0 W	4,0 W = 37 W		44 mA		420 lm		5902801339240





FR Source de lumière LED  
 ES Fuente de iluminación LED  
 DE LED-Leuchtmittel  
 HR LED žarulje

# G45

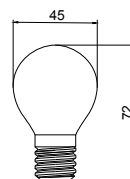
**NEW**

 3 years  
 warranty

**LED**  
LOW CONSUMPTION
**E27**

2-4 W



LD-G45FLE2EM-40	2,0 W	2,0 W = 21 W	F	22 mA	● 4000 K	200 lm	13 g	5902801358388
LD-G45FLE4EM-40	4,0 W	4,0 W = 37 W		44 mA		420 lm		5902801359095

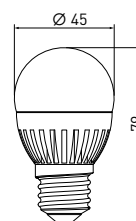

FR Source de lumière LED  
 ES Fuente de iluminación LED  
 DE LED-Leuchtmittel  
 HR LED žarulje

**NEW**

 3 years  
 warranty

**LED**  
LOW CONSUMPTION
**E27**

10 W



LD-SMBD45-10	10,0 W	10,9 W = 72 W	F	1000 lm	● 3000 K	80 mA	69 g	5902801362330
LD-SMNB45-10					● 4000 K			5902801361968



FR Source de lumière LED  
 ES Fuente de iluminación LED  
 DE LED-Leuchtmittel  
 HR LED žarulje

# G120

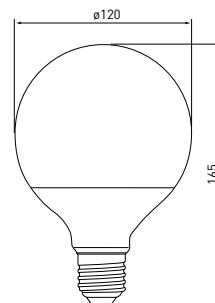
 3 years  
 warranty

**LED**  
LOW CONSUMPTION
**E27**

14-18 W



LD-120G14W-32	14,0 W	14,0 W = 92 W	F	122 mA	● 3000 K	1380 lm	107 g	5901867169242
LD-120G14W-40					● 4000 K			5902801299230
LD-120G18W-32	18,0 W	18,0 W = 116 W	F	157 mA	● 3000 K	1820 lm	155 g	5901867169259
LD-120G18W-40					● 4000 K			5902801299278





FR Source de lumière LED  
ES Fuente de iluminación LED  
DE LED-Leuchtmittel  
HR LED žarulje

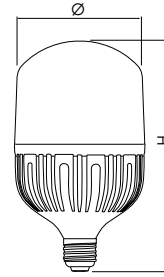

LD-ALF100-27W	27,0W	27,0 W = 172 W	E27	F	131 mA	● 4000 K	2900 lm	96	185	183 g	5902801374890
LD-ALF120-34W	34,0W	-			165 mA		3700 lm	115	207	248 g	5902801374883
LD-ALF140-43W	43,0W	-	E40		208 mA		4600 lm	149	245	353 g	5902801331510



FR Source de lumière LED  
 ES Fuente de iluminación LED  
 DE LED-Leuchtmittel  
 HR LED žarulje

## A60

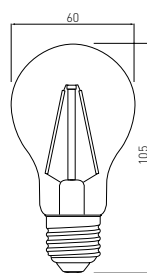

NEW

LED  
LIGHTING3  
years  
warranty

E27

8 W



LD-A60FLE8-30	8,0 W	8,0 W = 64 W	E	70 mA	● 3000 K	880 lm	34 g	5902801328770
LD-A60FLE8-40					● 4000 K			5902801356407



FR Source de lumière LED  
 ES Fuente de iluminación LED  
 DE LED-Leuchtmittel  
 HR LED žarulje

## G95

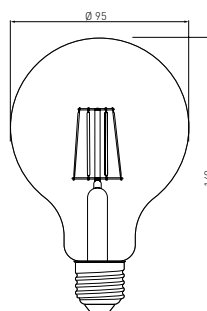

NEW

LED  
LIGHTING3  
years  
warranty

E27

8 W



LD-G95FLE8-30	8,0 W	8,0 W = 64 W	E	70 mA	● 3000 K	880 lm	100 g	5902801328800
LD-G95FLE8-40					● 4000 K			5902801339394



FR Source de lumière LED  
 ES Fuente de iluminación LED  
 DE LED-Leuchtmittel  
 HR LED žarulje

## G125

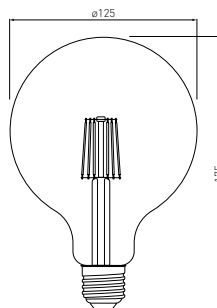

NEW

LED  
LIGHTING3  
years  
warranty

E27

8 W



LD-G125FLE8-30	8,0 W	8,0 W = 64 W	E	70 mA	● 3000 K	880 lm	200 g	5902801338465
LD-G125FLE8-40					● 4000 K			5902801358333



FR Source de lumière LED  
 ES Fuente de iluminación LED  
 DE LED-Leuchtmittel  
 HR LED žarulje

**ST64**

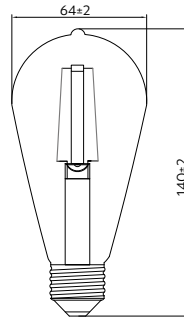

**NEW**

**LED**  
LIGHTING

**3**  
years  
warranty

**E27**

**6 W**

Lamps



LD-ST64FLE6-30	6,0 W	6,0 W = 48 W	F	52 mA	● 3000 K	600 lm	46 g	5902801358395
LD-ST64FLE6-40					● 4000 K			5902801339431





FR Source de lumière LED  
 ES Fuente de iluminación LED  
 DE LED-Leuchtmittel  
 HR LED žarulje

ST64

360°

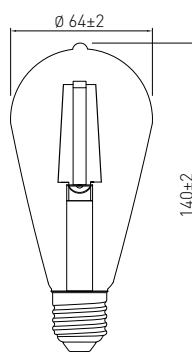

NEW

LED



4 W



LD-ST64FVE4-30

4,0 W

4,0 W = 28 W

G

44 mA

3000 K

300 lm

46 g

5902801339196



FR Source de lumière LED  
 ES Fuente de iluminación LED  
 DE LED-Leuchtmittel  
 HR LED žarulje

G95

360°

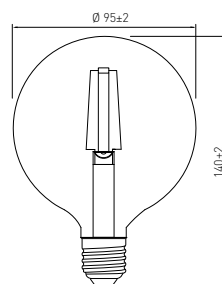

NEW

LED



4 W



LD-G95FEV4-30

4,0 W

4,0 W = 28 W

G

44 mA

3000 K

300 lm

56 g

5902801339295



FR Source de lumière LED  
 ES Fuente de iluminación LED  
 DE LED-Leuchtmittel  
 HR LED žarulje

G125

360°

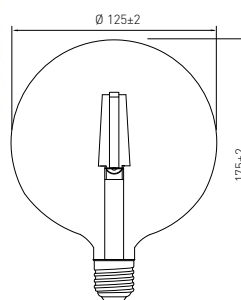

NEW

LED



4 W



LD-G125FEV4-30

4,0 W

4,0 W = 28 W

G

44 mA

3000 K

300 lm

100 g

5902801339288





FR Source de lumière LED  
 ES Fuente de iluminación LED  
 DE LED-Leuchtmittel  
 HR LED žarulje

## A60

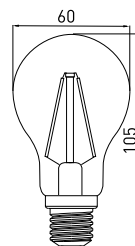

8 W



LD-A60FP8-18	8,0 W	8,0 W = 35 W	-	70 mA	1800 K	400 lm	75 g	5902801393419
LD-A60FPE8-30		8,0 W = 55 W	F		2700 K	720 lm		5902801358517



FR Source de lumière LED  
 ES Fuente de iluminación LED  
 DE LED-Leuchtmittel  
 HR LED žarulje

## G95

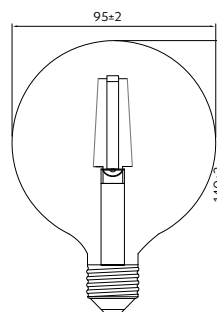

8 W



LD-G95FP8-18	8,0 W	8,0 W = 39 W	-	70 mA	1800 K	450 lm	150 g	5902801393358
LD-G95FPE8-30		8,0 W = 55 W	F		2700 K	720 lm		5902801328800



FR Source de lumière LED  
 ES Fuente de iluminación LED  
 DE LED-Leuchtmittel  
 HR LED žarulje

## G125

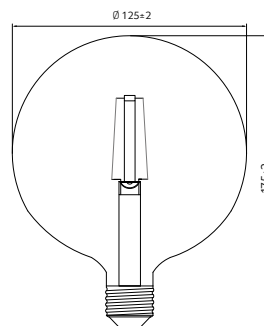

8 W



LD-G125FP8-18	8,0 W	8,0 W = 39 W	-	70 mA	1800 K	450 lm	250 g	5902801398100
LD-G125FPE8-30		8,0 W = 55 W	F		2700 K	720 lm		5902801359293





FR Source de lumière LED  
 ES Fuente de iluminación LED  
 DE LED-Leuchtmittel  
 HR LED žarulje

**ST64**

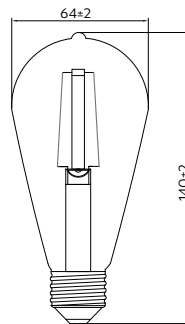

**NEW**

**LED**  
LIGHTING

**3**  
years  
warranty



**6 W**

Lamps



LD-ST64FP4-18	6,0 W	6,0 W = 28,0 W	-	43 mA	● 1800 K	300 lm	45 g	5902801370526
LD-ST64FPE6-30		6,0 W = 42 W	F	52 mA	● 2700 K	500 lm	46 g	5902801359255





FR Source de lumière LED  
 ES Fuente de iluminación LED  
 DE LED-Leuchtmittel  
 HR LED žarulje

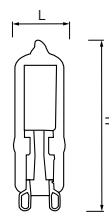

NEW

LED  
LIGHTING3  
years  
warranty

G9

3-4 W



LD-G93WE25-30	2,5 W	2,5 W = 25 W	F	27 mA	● 3000 K	250 lm	14 x 48	7 g	5902801339455
LD-G93WE25-40					● 4000 K				5902801339158
LD-G935W04-30	3,5 W	3,5 W = 32 W	F	38 mA	● 3000 K	350 lm	13,4 x 60	9 g	5902801359231
LD-G935W04-40					● 4000 K				5902801351457

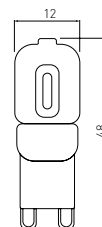

FR Source de lumière LED  
 ES Fuente de iluminación LED  
 DE LED-Leuchtmittel  
 HR LED žarulje

3  
years  
warrantyLED  
LIGHTING

G9

3 W



LD-G93W25-32	2,5 W	2,5 W = 22 W	F	27 mA	● 3000 K	220 lm	40 g	5902801328336
LD-G93W25-45					● 4000 K			5902801328640

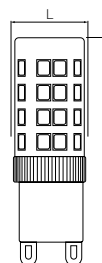

FR Source de lumière LED  
 ES Fuente de iluminación LED  
 DE LED-Leuchtmittel  
 HR LED žarulje

3  
years  
warrantyLED  
LIGHTING

G9

4-5 W



LD-G9PE35W-30	3,5 W	3,5 W = 32 W	F	38 mA	● 3000 K	350 lm	15 x 50	12 g	5902801328312
LD-G9PE35W-40					● 4000 K				5902801328695
LD-G9P5WE0-30	5,0 W	5,0 W = 35 W	G	54 mA	● 3000 K	400 lm	15 x 54,5	14 g	5902801328879
LD-G9P5WE0-40					● 4000 K				5902801338496



FR Source de lumière LED  
 ES Fuente de iluminación LED  
 DE LED-Leuchtmittel  
 HR LED žarulje

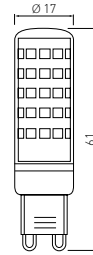

LD-G9P67W0-30	6,5 W	6,5 W = 48 W	F	57 mA	● 3000 K	600 lm	18 g	5902801339141
LD-G9P67W0-40					● 4000 K			5902801338540



FR Source de lumière LED  
 ES Fuente de iluminación LED  
 DE LED-Leuchtmittel  
 HR LED žarulje

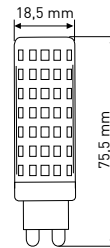

LD-G9P95W0-30	9,5 W	9,5 W = 66 W	F	83 mA	● 3000 K	900 lm	200 g	5902801351617
LD-G9P95W0-40					● 4000 K			5902801351464



FR Source de lumière LED  
 ES Fuente de iluminación LED  
 DE LED-Leuchtmittel  
 HR LED žarulje

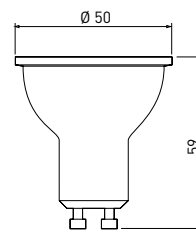

LD-SPCGU10-7W	7,0 W	7,0 W = 48 W	F	61 mA	● 3000 K	600 lm	70 g	5902801295010
LD-SPNGU10-7W					● 4000 K			5902801295010





FR Source de lumière LED  
ES Fuente de iluminación LED  
DE LED-Leuchtmittel  
HR LED žarulje

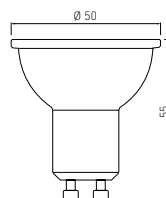

NEW

LED  
TECHNOLOGY3  
years  
warranty

GU10

1-4 W



LD-NGU10P-1W	1,0 W	1,0 W = 12 W	E	14 mA	3000 K	110 lm	120°	37 g	5902801407253
LD-NGU10PN-1W					4000 K				5901867194954
LD-NGU10PZ-1W					6400 K				5902801407079
LD-NGU10P-3W	2,5 W	2,5 W = 24 W	F	27 mA	3000 K	240 lm	120°	37 g	5901867131591
LD-NGU10PN-3W					4000 K				5902801299070
LD-NGU10PZ-3W					6400 K				5902801407291
LD-NGU10P-4W	3,5 W	3,5 W = 32 W	F	38 mA	3000 K	350 lm	120°	37 g	5908231395702
LD-NGU10PN-4W					4000 K				5902801299001
LD-NGU10PZ-4W					6400 K				5902801407420

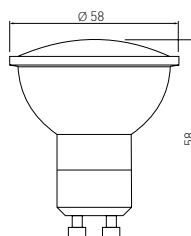

FR Source de lumière LED  
ES Fuente de iluminación LED  
DE LED-Leuchtmittel  
HR LED žarulje

3  
years  
warrantyLED  
TECHNOLOGY

GU10

4 W



LD-SZ1510-30	4,0 W	4,0 W = 30 W	F	43 mA	3000 K	320 lm	45 g	5901867109712
LD-SZ1510-40					4000 K			5901867109729
LD-SZ1510-64					6400 K			5901867109743

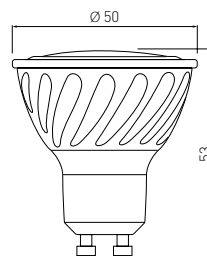

FR Source de lumière LED  
ES Fuente de iluminación LED  
DE LED-Leuchtmittel  
HR LED žarulje

3  
years  
warrantyLED  
TECHNOLOGY

GU10

6-7 W



LD-PC6010-30	5,6 W	5,6 W = 36 W	F	49 mA	3000 K	410 lm	52 g	5901867155436
LD-PC6010-40					4000 K			5901867198785
LD-PC6010-64					6400 K			5901867197139
LD-PC7510-30	7,0 W	7,0 W = 45 W	F	61 mA	3000 K	550 lm	52 g	5901867155405
LD-PC7510-40					4000 K			5901867198792
LD-PC7510-64					6400 K			5901867197160



FR Source de lumière LED  
 ES Fuente de iluminación LED  
 DE LED-Leuchtmittel  
 HR LED žarulje



LED  
TECHNOLOGY

GU10

9 W

LD-SM1210-10						3000 K			5901867189967
LD-SM1210N-10	9,1 W	9,1 W = 63 W	F	80 mA		4000 K	850 lm	50 g	5902801299513
LD-SM1210Z-10						6400 K			5902801342790



FR Source de lumière LED  
 ES Fuente de iluminación LED  
 DE LED-Leuchtmittel  
 HR LED žarulje



LED  
TECHNOLOGY

GU10

5 W

LD-SZ5010-30						3000 K			5901867196798
LD-SZ5010-40	5,0 W	5,0 W = 35 W	F	54 mA		4000 K	400 lm	45 g	5902801000690
LD-SZ5010-64						6400 K			5901867196804



FR Source de lumière LED  
 ES Fuente de iluminación LED  
 DE LED-Leuchtmittel  
 HR LED žarulje

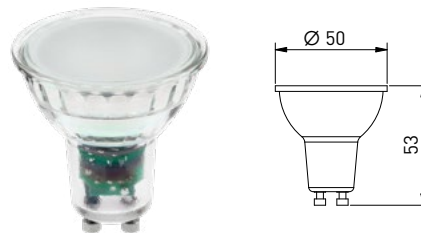

LED  
TECHNOLOGY

GU10

3 - 7 W

LD-SZ30W10-30	3,0	3,0 W = 26 W				3000 K	270 lm	>0,4		5902801360817
LD-SZ30W10-40	3,0	3,0 W = 26 W		33 mA		4000 K	270 lm	>0,4		5902801360848
LD-SZ30W10-64	3,0	3,0 W = 26 W				6400 K	270 lm	>0,4		5902801360855
LD-SZ50W10-30	5,0	5,0 W = 39 W				3000 K	460 lm	>0,4		5902801361005
LD-SZ50W10-40	5,0	5,0 W = 39 W	F	54 mA		4000 K	460 lm	>0,4	46g	5902801361142
LD-SZ50W10-64	5,0	5,0 W = 39 W				6400 K	460 lm	>0,4		5902801360992
LD-SZ70W10-30	6,7	6,7 W = 52 W				3000 K	670 lm	>0,5		5902801361180
LD-SZ70W10-40	6,7	6,7 W = 52 W		58 mA		4000 K	670 lm	>0,5		5902801361531
LD-SZ70W10-64	6,7	6,7 W = 52 W				6400 K	670 lm	>0,5		5902801361043

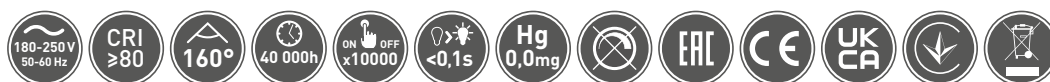



FR Source de lumière LED  
 ES Fuente de iluminación LED  
 DE LED-Leuchtmittel  
 HR LED žarulje

J78

360°

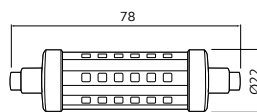
3  
years  
warranty

LED



R7s

5 W



LD-J7806WE-40	5,0 W	5,0 W = 42 W	F	54 mA	● 4000 K	500 lm	240 g	5902801339066
---------------	-------	--------------	---	-------	----------	--------	-------	---------------



FR Source de lumière LED  
 ES Fuente de iluminación LED  
 DE LED-Leuchtmittel  
 HR LED žarulje

J78

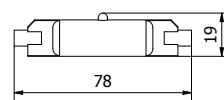
3  
years  
warranty

LED



R7s

5 W



LD-J7805WCE-40	5,0 W	5,0 W = 42 W	F	54 mA	● 4000 K	500 lm	150 g	5902801359316
----------------	-------	--------------	---	-------	----------	--------	-------	---------------



FR Source de lumière LED  
 ES Fuente de iluminación LED  
 DE LED-Leuchtmittel  
 HR LED žarulje

J118

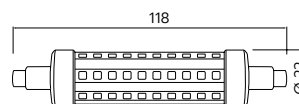
3  
years  
warranty

LED



R7s

9 W



LD-J11810WE-40	9,0 W	9,0 W = 66 W	F	78 mA	● 4000 K	900 lm	390 g	5902801339059
----------------	-------	--------------	---	-------	----------	--------	-------	---------------



FR Source de lumière LED  
 ES Fuente de iluminación LED  
 DE LED-Leuchtmittel  
 HR LED žarulje



R7s

9 W

J118

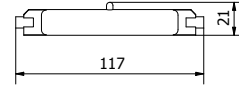

LD-J11809WCE-40	9,0 W	9,0 W = 66 W	F	78 mA	● 4000 K	900 lm	200 g	5902801351426
-----------------	-------	--------------	---	-------	----------	--------	-------	---------------





FR Source de lumière LED  
ES Fuente de iluminación LED  
DE LED-Leuchtmittel  
HR LED žarulje

NEW

LED  
TECHNOLOGY3  
years  
warranty

GU10

13 W



LD-ES111WW13W40-10  
LD-ES111NW13W40-10



LD-ES111WW13W40-00  
LD-ES111NW13W40-00



LD-ES111WW13W40-15  
LD-ES111NW13W40-15

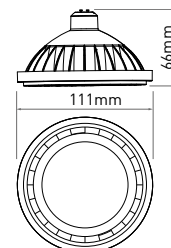

LD-ES111WW13W40-10	12,5 W	F	109 mA	● 3000 K	1100 lm	40°	95 g	5902801343780
LD-ES111NW13W40-10		E		● 4000 K	1250 lm	40°		5902801343797
LD-ES111WW13W120-10		F		● 3000 K	1100 lm	120°		5902801347467
LD-ES111NW13W120-10		E		● 4000 K	1250 lm	120°		5902801347160
LD-ES111WW13W40-00		F		● 3000 K	1100 lm	40°		5902801343551
LD-ES111NW13W40-00		E		● 4000 K	1250 lm	40°		5902801343001
LD-ES111WW13W120-00		F		● 3000 K	1100 lm	120°		5902801347559
LD-ES111NW13W120-00		E		● 4000 K	1250 lm	120°		5902801347672
LD-ES111WW13W40-15		F		● 3000 K	1100 lm	40°		5902801347238
LD-ES111NW13W40-15		E		● 4000 K	1250 lm	40°		5902801347177
LD-ES111WW13W120-15		F		● 3000 K	1100 lm	120°		5902801347658
LD-ES111NW13W120-15		E		● 4000 K	1250 lm	120°		5902801347757



FR Source de lumière LED  
ES Fuente de iluminación LED  
DE LED-Leuchtmittel  
HR LED žarulje

NEW

LED  
TECHNOLOGY3  
years  
warranty

G53

13 W



LD-AR111WW13W40-10  
LD-AR111NW13W40-10



LD-AR111WW13W40-00  
LD-AR111NW13W40-00

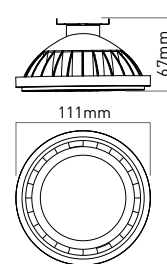

LD-AR111WW13W40-10	12,5 W	F	113 g	● 3000 K	1100 lm	40°	5902801343599
LD-AR111NW13W40-10				● 4000 K	1250 lm	40°	5902801343667
LD-AR111WW13W120-10				● 3000 K	1100 lm	120°	5902801347818
LD-AR111NW13W120-10				● 4000 K	1250 lm	120°	5902801347955
LD-AR111WW13W40-00				● 3000 K	1100 lm	40°	5902801347511
LD-AR111NW13W40-00				● 4000 K	1250 lm	40°	5902801343759
LD-AR111WW13W120-00				● 3000 K	1100 lm	120°	5902801347986
LD-AR111NW13W120-00				● 4000 K	1250 lm	120°	5902801348310





FR Source de lumière LED  
ES Fuente de iluminación LED  
DE LED-Leuchtmittel  
HR LED žarulje

**NEW**

LED  
TECHNOLOGY

3  
years  
warranty

GU10

11 W

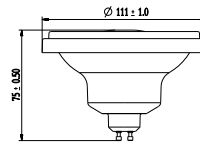

LD-ES111WW11W25AG-01	11,0 W	F	96 mA	3000 K	850 lm	25°	95 g	5902801343711
LD-ES111NW11W25AG-01				4000 K	900 lm			5902801347498

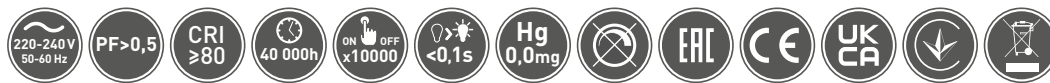

FR Source de lumière LED  
ES Fuente de iluminación LED  
DE LED-Leuchtmittel  
HR LED žarulje

LED  
TECHNOLOGY

3  
years  
warranty

MR16

4 W

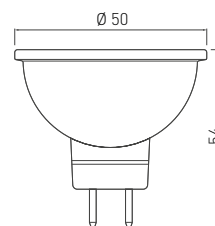

LD-SM4016-30	4,0 W	4,0 W = 30 W	G	3000 K	320 lm	30 g	5901867190079
LD-SM4016-40				4000 K			5902801309328
LD-SM4016-64				6400 K			5901867190109

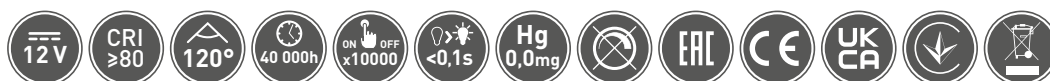

FR Source de lumière LED  
ES Fuente de iluminación LED  
DE LED-Leuchtmittel  
HR LED žarulje

LED  
TECHNOLOGY

3  
years  
warranty

MR16

6 W

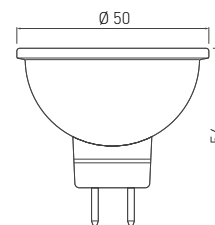

LD-SM6016-30	6,0 W	6,0 W = 44 W	G	3000 K	540 lm	30 g	5901867190048
LD-SM6016-40				4000 K			5902801338281
LD-SM6016-64				6400 K			5902801339738

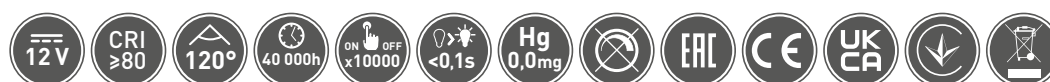



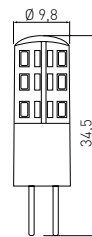

FR Source de lumière LED  
 ES Fuente de iluminación LED  
 DE LED-Leuchtmittel  
 HR LED žarulje

LED  
LED...  
LED...

G4

1 W



LD-G4S1115-32	1,1 W	1,1 W = 11 W	G	● 3000 K	100 lm	3 g	5902801328657
LD-G4S1115-45				● 4000 K			5902801328329

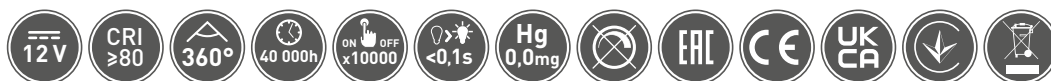

FR Source de lumière LED  
 ES Fuente de iluminación LED  
 DE LED-Leuchtmittel  
 HR LED žarulje

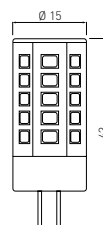
LED  
LED...  
LED...

G4

3 W



LD-G4P30W-30	3,0 W	3,0 W = 26 W	G	● 3000 K	260 lm	11 g	5902801338533
LD-G4P30W-40				● 4000 K			5902801338519

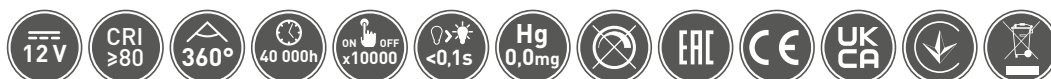

FR Source de lumière LED  
 ES Fuente de iluminación LED  
 DE LED-Leuchtmittel  
 HR LED žarulje



LD-G4018W-30

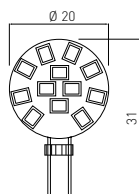

LD-G4025W-30

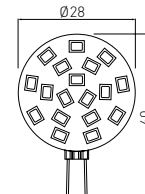
LED  
LED...  
LED...

G4

2 - 3 W



LD-G4018W-30	1,8 W	1,8 W = 16 W	G	● 3000 K	150 lm	1,7 g	5902801339042
LD-G4025W-30	2,5 W	2,5 W = 25 W	F		250 lm	2,9 g	5902801338908

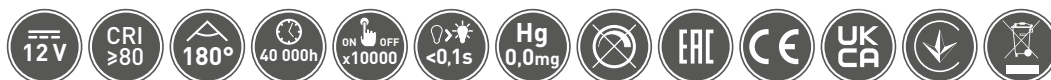







TUBES LED T8  
T8 TUBOS FLUORESCENTES LED  
LED-LEUCHTRÖHREN VOM TYP T8  
LED CIJEVI T8

FR Source de lumière LED  
ES Fluorescente de Led  
DE LED-Leuchtmittel  
HR LED cijevi



SW-NSZT810W-60N, SW-ZSZT810W-60N



SW-NSZT819W-120N, SW-ZSZT819W-120N



SW-NSZT824W-150N, SW-ZSZT824W-150N

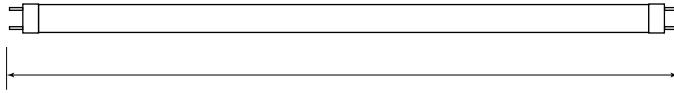

600 mm SW-NSZT810W-60N, SW-ZSZT810W-60N  
1200 mm SW-NSZT819W-120N, SW-ZSZT819W-120N  
1500 mm SW-NSZT824W-150N, SW-ZSZT824W-150N

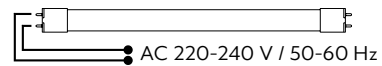

Product Code	Power (W)	Beam Angle (°)	Current (mA)	Color Temp (K)	Lumen (lm)	Weight (g)	Barcode
SW-NSZT810W-60N	9,1 W	F	80 mA	4000 K	1000 lm	115 g	5902801366369
SW-ZSZT810W-60N	9,1W		80 mA	6400 K	1000 lm	115 g	5902801367250
SW-NSZT818W-120N	18,0 W		157 mA	4000 K	1900 lm	220 g	5902801367212
SW-ZSZT818W-120N	18,0 W		157 mA	6400 K	1900 lm	220 g	5902801367281
SW-NSZT822W-150N	22,0 W		192 mA	4000 K	2400 lm	275 g	5902801367229
SW-ZSZT822W-150N	22,0 W		192 mA	6400 K	2400 lm	275 g	5902801367304



FR Source de lumière LED, T8  
ES Fluorescente de Led T8  
DE LED-Leuchtmittel, T8  
HR LED cijevi T8

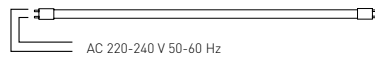

Product Code	Power (W)	Beam Angle (°)	Current (mA)	Color Temp (K)	Lumen (lm)	Length (mm)	Barcode
SW-HLSZT809W-60	9,0 W	E	78 mA	4000 K	1050 lm	600 mm	5902801241444
SW-HLSZT818W-120	18,0 W		157 mA		2150 lm	1200 mm	5902801241451
SW-HLSZT824W-150	24,0 W		209 mA		2850 lm	1500 mm	5902801241871









LUMINAIRES INDUSTRIELS  
LUMINARIA TÉCNICA E INDUSTRIAL  
TECHNISCHE UND INDUSTRIELEUCHTEN  
TEHNIČKA I INDUSTRIJSKA RASVJETA



Lampes LED Paneles y luminarias LED LED-Panele und LED-Leuchten LED paneli i svjetiljke .....	65
Lampes traditionnelles Luminarias LED industriales LED Industrielleuchten Luminaires Industriels .....	76
Plafonnier LED Plafones y luminarias para sótanos Decken- und Feuchtraum-/Außenleuchten LED plafonjere i brodske svjetiljke.....	86
Downlights Luminarias LED tipo downlight Downlight Downlight LED svjetiljk.....	104
Projecteurs Proyectores LED LED Flutlichtstarahler LED reflektori .....	126
High bay luminaires LED Luminarias LED tipo high bay Highbay led-leuchten High Bay LED svjetiljke .....	132
Eclairage public Luminarias LED de para calles y parques Straßen- und Parkleuchten LED LED ulične svjetiljke .....	138
Appareils d'éclairage d'urgence Luminarias LED de emergencia Notbeleuchtung Panik LED lampe.....	142
Luminaires grilles Luminarias con rejilla Rasterleuchten Raster svjetiljke.....	146
Luminaires Industriels Luminarias industriales Industrielleuchten Industrijske svjetiljke .....	150
Plafonnier LED Plafones y luminarias para sótanos Decken- und Feuchtraum-/Außenleuchten Plafonjere i brodske svjetiljke .....	154
Eclairage d'atelier et lampes torches LED Luminarias de taller y linternas LED Werkstattleuchten und LED-Taschenlampen Radioničke i ručne svjetiljke .....	162



LAMPES LED  
PANELES Y LUMINARIAS LED  
LED-PANELE UND LED-LEUCHTEN  
LED PANELI I SVJETILJKE



FR Cadre LED  
ES Marco LED  
DE LED-Rahmen  
HR LED okvir

## AKORDITA

LED  
TECHNOLOGY



40 W

3 years  
warranty

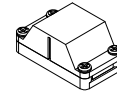

Accessoires  
Accesorios  
Zubehör  
Dodatna oprema:  
LZ-KOI2KO-10

Technische  
und industrielleuchten

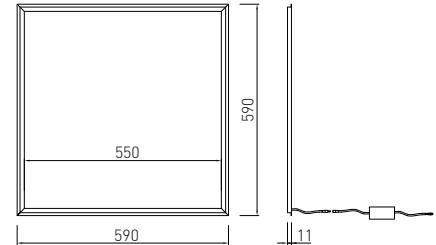
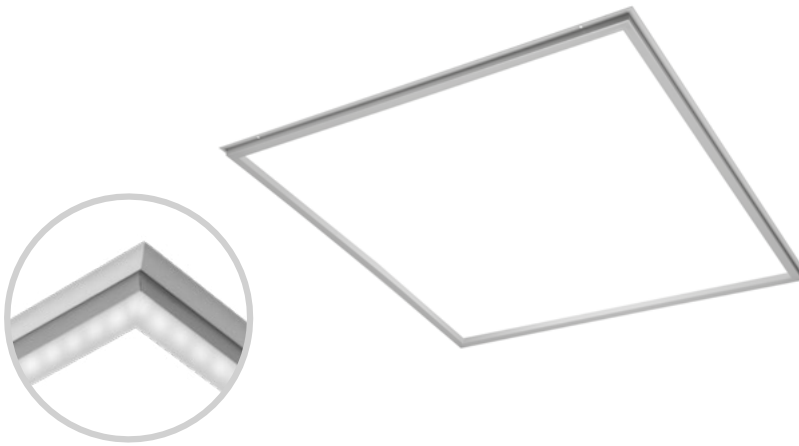

LD-AKO4060-NB

40 W

● 4000 K

3600 lm

aluminium,  
aluminio,  
Aluminium,  
aluminij

blanc,  
blanco,  
weiß,  
bijeli

500 g

5902801039966



FR Luminaire LED  
ES Luminaria LED  
DE LED-Leuchte  
HR LED rasvjetno tijelo

## SOLID

NEW

LED  
TECHNOLOGY



36 W

3 years  
warranty

UGR<16

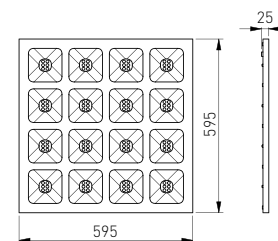
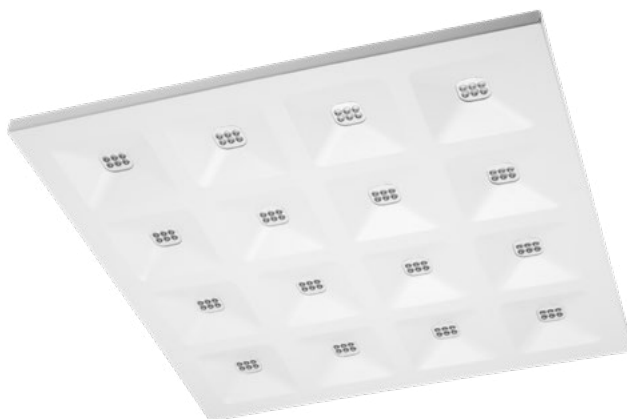

LD-SOL36W40-NB

36 W

● 4000 K

4800 lm

blanc, blanco, weiß, bijeli

2850 g

5902801393372





FR Luminaire LED  
ES Luminaria LED  
DE LED-Leuchte  
HR LED rasvjetno tijelo



**40 W**

**5 years**  
warranty

**MODULAR**

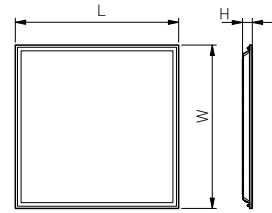

	L	W	H
LD-MOD4060-NB	595 mm	595 mm	25 mm

Technische  
und industrielleuchten



LD-MOD4060-NB	40 W	4000 K	4800 lm	aluminium, aluminio, Aluminium, aluminij	blanc, blanco, weiß, bijeli	1800 g	5902801372698



FR Luminaire LED  
ES Luminaria LED  
DE LED-Leuchte  
HR LED rasvjetno tijelo



**40 W**

**UGR<19**

**5 years**  
warranty

**MODULAR UGR**

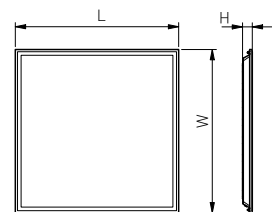

	L	W	H
LD-MOD4060UGR-NB	595 mm	595 mm	25 mm
LD-MOD12030UGR-NB	295 mm	1195 mm	25 mm

LD-MOD4060UGR-NB	40 W	4000 K	4200 lm	aluminium, aluminio, Aluminium, aluminij	blanc, blanco, weiß, bijeli	1800 g	5902801372872
LD-MOD12030UGR-NB							5902801372636





FR Luminaire LED  
ES Luminaria LED  
DE LED-Panel  
HR LED panel



40 W

**GALAXY**

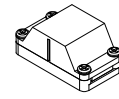

Accessoires  
Accesorios  
Zubehör  
Dodatna oprema:  
LZ-KOI2KO-10

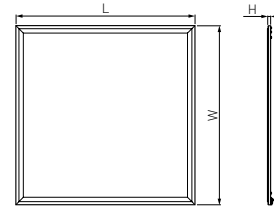

LD-GL40060-NB	40 W	● 4000 K	4400 lm	aluminium, aluminio, Aluminium, aluminij	595 × 595 × 10	blanc, blanco, weiß, bijeli	2700 g	5901867195180
LD-GL40120-NB					1195 × 295 × 10			5901867195357



Technische  
und industrieleuchten





FR Luminaire LED  
ES Luminaria LED  
DE LED-Panel  
HR LED panel

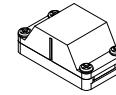

Accessoires  
Accesorios  
Zubehör  
Dodatna oprema:  
LZ-KOI2KO-10

## GALAXY UGR

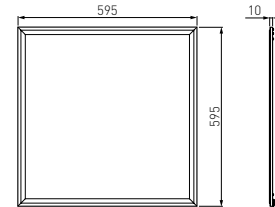

Technische  
und industrielleuchten



LD-GL40060UGR-NB	40 W	4000 K	4400 lm	aluminium, aluminio, Aluminium, aluminij	blanc, blanco, weiß, bijeli	2700 g	5901867195456
------------------	------	--------	---------	---	-----------------------------	--------	---------------



FR Luminaire LED  
ES Luminaria LED  
DE LED-Panel  
HR LED panel

**NEW**

## MASTER

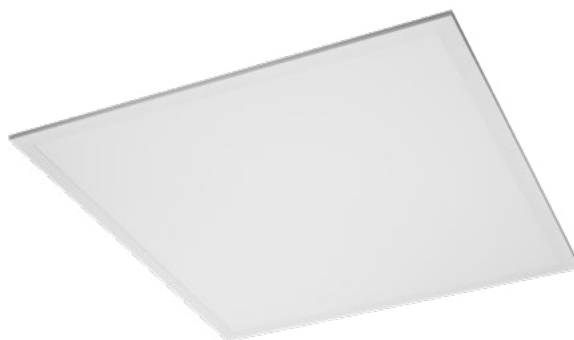

LD-MA24063-NB	24 W	4000 K	2400 lm	aluminium, aluminio, Aluminium, aluminij	595 x 295 x 8	blanc, blanco, weiß, bijeli	1300 g	5902801372568
LD-MA40060-NB	40 W		4200 lm		595 x 595 x 10		1820 g	5902801292132
LD-MA40312-NB			1195 x 295 x 10		1860 g		5902801292156	

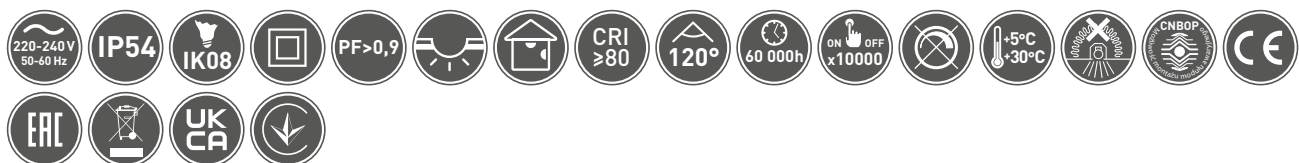



FR Luminaire LED  
ES Luminaria LED  
DE LED-Paneel  
HR LED panel

## KING+

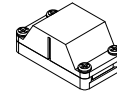

Accessoires  
Accesorios  
Zubehör  
Dodatna oprema:  
LZ-KO12KO-10

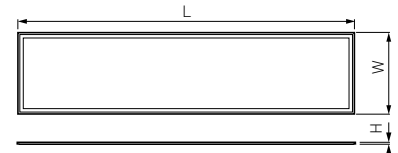

Technische  
und industrielleuchten



LD-KNG45060-NB	45 W	● 4000 K	4500 lm	aluminium, aluminio, Aluminium, aluminij	595 x 595 x 10	blanc, blanco, weiß, bijeli	2780 g	5902801270307
LD-KNG45312-NB					1195 x 295 x 10			5902801270567



FR Luminaire LED  
ES Luminaria LED  
DE LED-Paneel  
HR LED panel

## ARGO

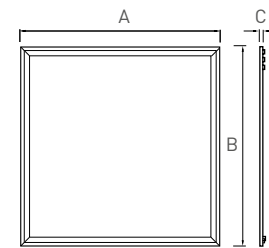

30-55 W



A

B

C

LD-ARG30W60-NB	445 mm	445 mm	26 mm
LD-ARG40W60-NB	595 mm	595 mm	
LD-ARG55W60-NB			



LD-ARG30W60-NB	30 W	● 4000 K	3000 lm	Metall + plastique, Metall + plástico, Metall + Kunststoff, metalni + plastika	blanc, blanco, weiß, bijeli	1500 g	5902801312359
LD-ARG40W60-NB	40 W		4000 lm			2000 g	5902801345449
LD-ARG55W60-NB*	55 W		5500 lm			2000 g	5902801345456



FR Luminaire LED  
ES Luminaria LED  
DE LED-Panel  
HR LED panel

**ELZA**



625 x 625 mm

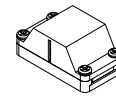

Accessoires  
Accesorios  
Zubehör  
Dodatna oprema:  
LZ-KOI2KO-10

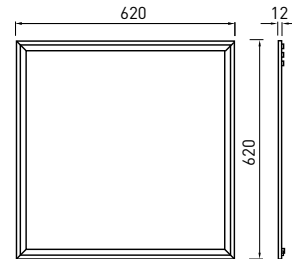

**40 W**

**5**  
years  
warranty

LD-DE40062-NB	40 W	● 4000 K	4400 lm	aluminium, aluminio, Aluminium, aluminij	blanc, blanco, weiß, bijeli	3000 g	5902801125379



Technische  
und industrieleuchten

FR Luminaire LED  
ES Luminaria LED  
DE LED-Panel  
HR LED panel

**ELZA UGR**



625 x 625 mm

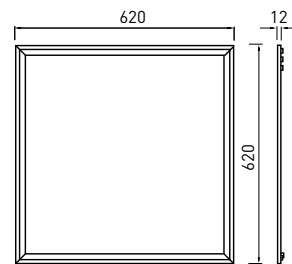

**40 W**

**UGR<19**

**5**  
years  
warranty

LD-DE40062UGR-NB	40 W	● 4000 K	4400 lm	aluminium, aluminio, Aluminium, aluminij	blanc, blanco, weiß, bijeli	3000 g	5902801298905





- FR Câbles de montage pour dalles suspendues 1,5 m  
 ES Juego de cables de montaje para colgar paneles 1,5 m  
 DE Montageleinen-Satz zum Aufhängen des Paneels 1,5 m  
 HR Set pribora za ovjesnu montažu panela 1,5 m



LK-PANELX4-00	Metall, Metall, Metall, metalni	1,5 m	4	5902801270307
---------------	---------------------------------	-------	---	---------------



- FR Kit de montage pour panneaux encastrés  
 ES Juego de montaje para paneles empotrados  
 DE Satz für Unterputzmontage des Paneels  
 HR Set kopča za ugradnu montažu LED panela



ZM-PANELSC-00	Metall, Metall, Metall, metalni	4	5901867158079
---------------	---------------------------------	---	---------------

- FR Kit de montage pour panneaux muraux  
 ES Juego de montaje para paneles de pared  
 DE Satz für Aufputzmontage  
 HR Set kopča za zidnu montažu LED panela





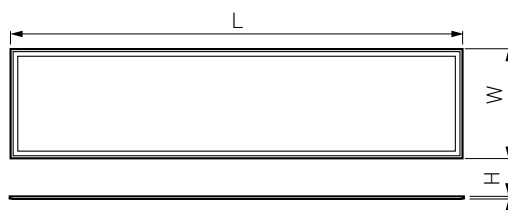
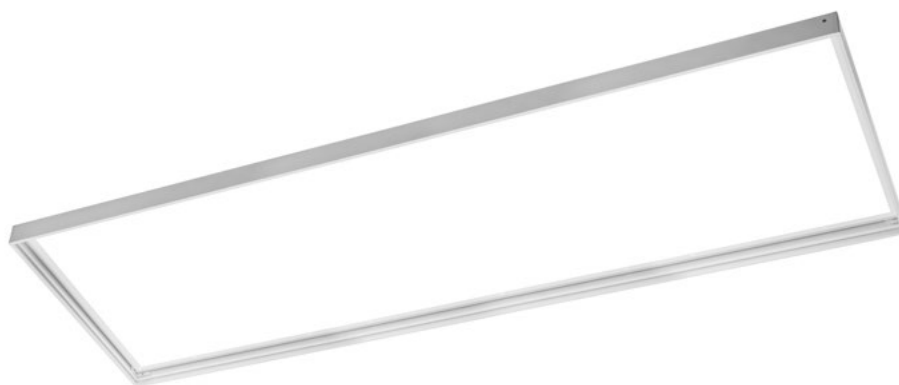

ZM-PANELSU-00	Metall, Metall, Metall, metalni	4	5901867158055
---------------	---------------------------------	---	---------------

FR Cadre de montage en applique  
ES Marco para montaje superficial  
DE Aufputzmontagerahmen für Panele  
HR Nadgradni okvir za montažu panela



Technische  
und industrieleuchten



	 LxWxH mm			
RM-DE625X625-00	625 x 625 x 43	aluminium, aluminio, Aluminium, aluminij	blanc, blanco, weiß, bijeli	5902801073137
RM-KNG60X60-00	600 x 600 x 43			5901867168580
RM-KNG300X600-00	600 x 300 x 43			5901867179753
RM-KNG300X120-00	1200 x 300 x 43			5901867179777
GT-RM60X60-00	600x600x43			5902801276088
GT-RM30X60-00	600x300x43			5902801276163
GT-RM30X120-00	1200x300x43			5902801276071
RM-MA60X60-00	600 x 600 x 43		gris, gris, grau, sivi	5901867157249



LAMPES TRADITIONNELLES  
LUMINARIAS LED INDUSTRIALES  
LED INDUSTRIELEUCHTEN  
LUMINAIRES INDUSTRIELS

FR Luminaire LED hermétique  
ES Luminaria LED hermética  
DE Hermetische Leuchte LED  
HR LED vodotjesna svjetiljka



50-70 W

## BERGA

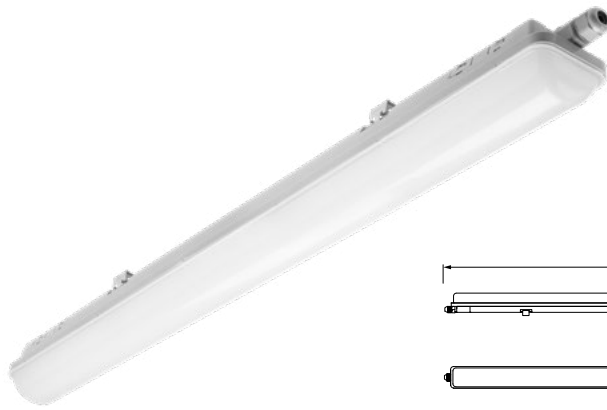

	Ⓜ	LN	●●●	☀	⊞	LxWxH mm	🍷	🏠	📊
LD-BERGA50W-30	50 W	max 10	● 4000 K	7000 lm	ABS/PC	1190 × 75 × 77	gris, gris, grau, sivi	1360 g	5902801253188
LD-BERGA70W-30	70 W	max 7		9800 lm					1570 × 75 × 77



Technische  
und industrieleuchten

FR Luminaire LED hermétique  
ES Luminaria LED hermética  
DE Hermetische Leuchte LED  
HR LED vodotjesna svjetiljka

## BETIS



50-70 W



	Ⓜ	LN	●●●	☀	⊞	LxWxH mm	🍷	🏠	📊
LD-BETISD50W-30	50 W	max 22	● 4000 K	6000 lm	PC	1200 × 75 × 95	blanc, blanco, weiß, bijeli	680 g	5902801015670
LD-BETISD70W-30	70 W	max 15		8400 lm					1500 × 75 × 95

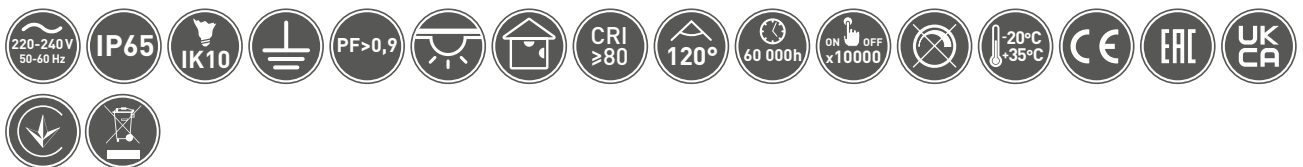



FR Luminaire LED hermétique  
ES Luminaria LED hermética  
DE Hermetische Leuchte LED  
HR LED vodotjesna svjetiljka

## LUNAR

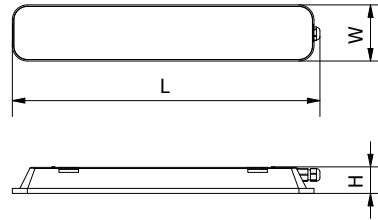
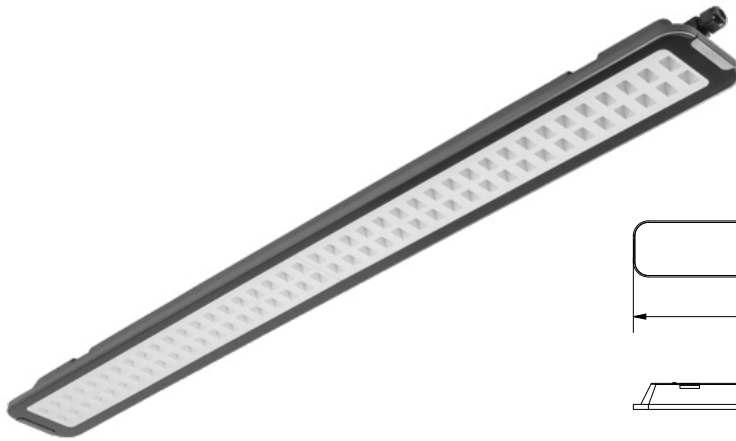

LED  
TECHNOLOGY



40-80 W



Technische  
und industrielleuchten



Model	Power (W)	Max. Temp	Color Temp (K)	Light Output (lm)	Material	Dimensions (mm)	Finish	Weight (g)	Barcode
LD-LUNAR60-40	40 W	max 20	● 4000 K	4000 lm	PC GLASS	620 x 118 x 53	gris, gris grau, sivi	1400 g	5902801297571
LD-LUNAR120-80	80 W	max 10		8000 lm		1160 x 118 x 53		2400 g	5902801297625



FR Luminaire LED hermétique  
ES Luminaria LED hermética  
DE Hermetische Leuchte LED  
HR LED vodotjesna svjetiljka

## BESTA

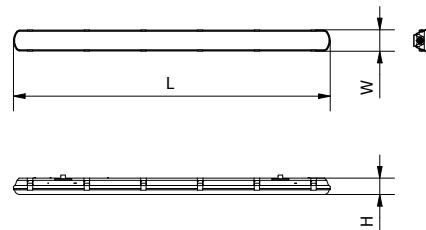

LED  
TECHNOLOGY



40-60 W



Model	Power (W)	Max. Temp	Color Temp (K)	Light Output (lm)	Material	Dimensions (mm)	Finish	Weight (g)	Barcode
LD-BESTA40W-30	40 W	max 27	● 4000 K	5600 lm	PC	1200 x 102 x 83	blanc, blanco, weiß, bije	1500 g	5902801234163
LD-BESTA60W-30	60 W	max 18		8400 lm		1500 x 102 x 83		2000 g	5902801225642







FR Luminaire LED hermétique  
ES Luminaria LED hermética  
DE Hermetische Leuchte LED  
HR LED vodotjesna svjetiljka

**XARO**

Technische  
und industrieleuchten

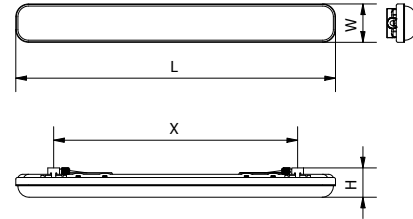

18-48 W



Model	Power (W)	Beam Spread	Color Temp (K)	Light Output (lm)	Material	LxWxH (mm)	X (mm)	IP Rating	Weight (g)	Barcode
LD-XARO18W-30	18 W	max 16		2200 lm		600 x 70 x 60	435-480 mm		1000 g	5902801234019
LD-XARO36W-30	36 W	max 12	● 4000 K	4400 lm	PC	1200 x 70 x 83	700-780 mm	blanc, blanco, weiß, bijeli	1300 g	5902801233906
LD-XARO48W-30	48 W	max 8		5800 im		1500 x 80 x 83	990-1050 mm		1800 g	5902801234248



FR Luminaire LED hermétique pour sources de lumière LED T8  
ES Luminaria LED hermética para fuentes de luz LED T8  
DE Hermetische LED-Leuchte für die Lichtquellen LED T8  
HR LED vodotjesna svjetiljka za T8 cijevi

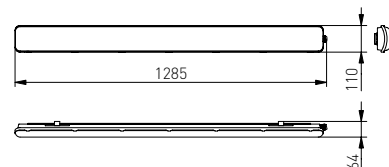
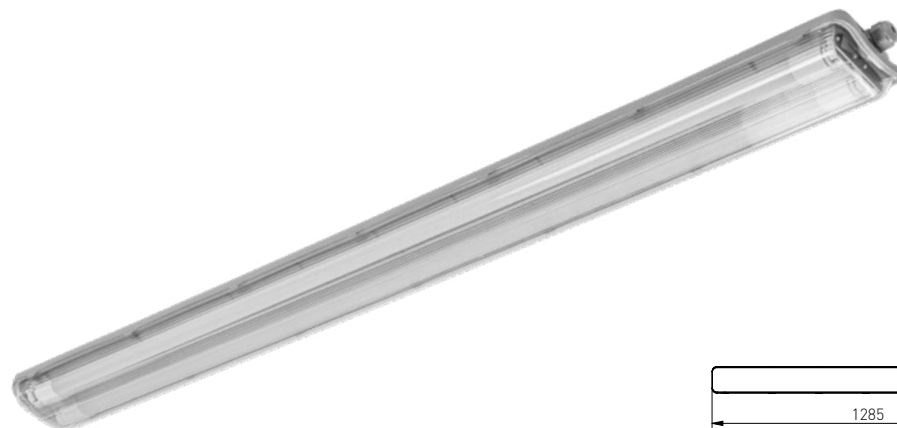

LD-HR2X18W12-30	● 4000 K	2 x 1800 lm	gris, gris, grau, sivi	ABS + PS	1300 g	5902801233913
-----------------	----------	-------------	------------------------	----------	--------	---------------



FR Luminaire LED hermétique  
ES Luminaria LED hermética  
DE Hermetische Leuchte LED  
HR LED vodotjesna svjetiljka

## OMNIA BIS

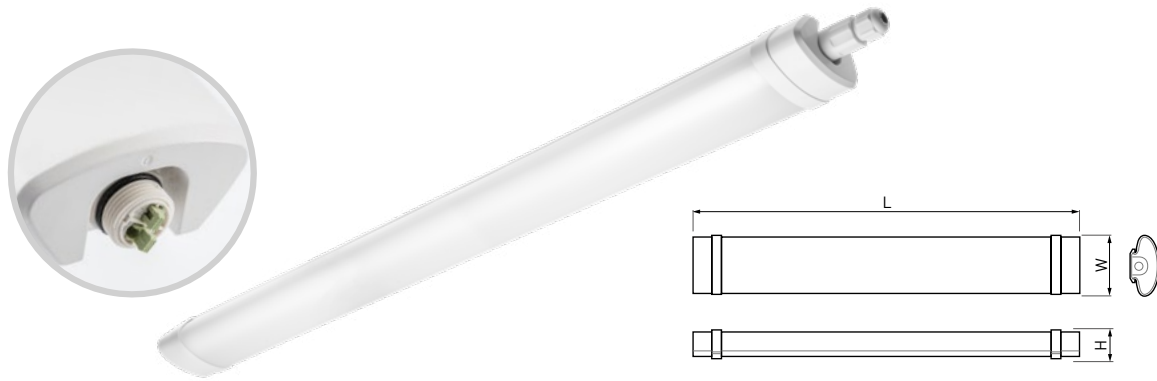

30-70 W



					LxWxH mm			
LD-OMN060-30B	30 W	● 4000 K	3000 lm	PC	640 x 85 x 50	blanc, blanco, weiß, bijeli	400 g	5902801038587
LD-OMN120-60B	60 W		6000 lm		1240 x 85 x 50		670 g	5902801038693
LD-OMN150-70B	70 W		7000 lm		1540 x 85 x 50		750 g	5902801038686



FR Luminaire LED hermétique  
ES Luminaria LED hermética  
DE Hermetische Leuchte LED  
HR LED vodotjesna svjetiljka

## OMNIA MAX BIS



75-90 W



		LN				LxWxH mm			
LD-OMN120B-75M	75 W	max 16	● 4000 K	7500 lm	PC	1240 x 120 x 54	blanc, blanco, weiß, bijeli	820 g	5902801233975
LD-OMN150B-90M	90 W	max 13		9000 lm		1540 x 120 x 54		980 g	5902801233999

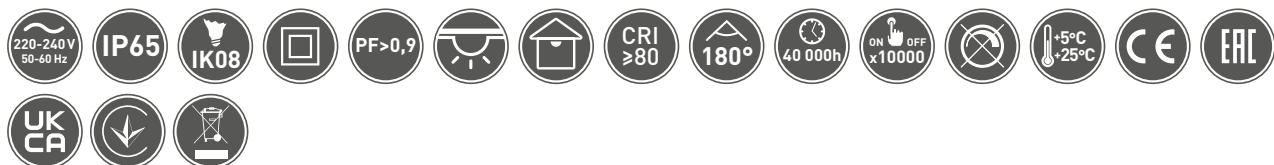



FR Luminaire LED hermétique  
ES Luminaria LED hermética  
DE Hermetische Leuchte LED  
HR LED vodotjesna svjetiljka

## LUMIA



LED  
TECHNOLOGY



36-45 W



Technische  
und industrielleuchten



LD-LUM120-30P	36 W	max 10	● 4000 K	3600 lm	PC	1205 x 49 x 56	blanc, blanco, weiß, bijeli	670 g	5901867155733
LD-LUM150-30P	45 W	max 8		4500 lm		1512 x 49 x 56		680 g	5901867155757



FR Luminaire LED hermétique  
ES Luminaria LED hermética  
DE Hermetische Leuchte LED  
HR LED vodotjesna svjetiljka

## HEROS

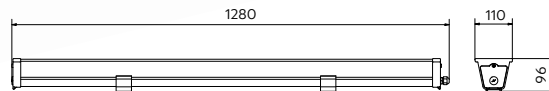
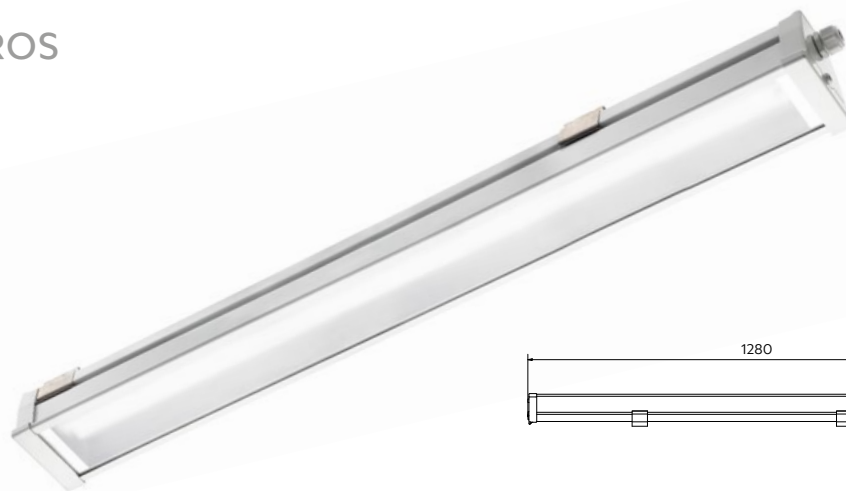

LED  
TECHNOLOGY



36 W



LD-HER60W12-NB	60 W	20	● 4000 K	8400 lm	aluminium + Verre trempé, aluminio + vidrio templado, Aluminium, Gehärtetes Glas aluminij + kaljeno staklo	blanc, blanco, weiß, bijeli	4200 g	5902801274404
----------------	------	----	----------	---------	---	--------------------------------------	--------	---------------



FR Luminaire LED  
ES Luminaria LED  
DE LED-Leuchte  
HR LED nadgradna svjetiljka

## LONGI

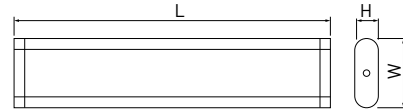
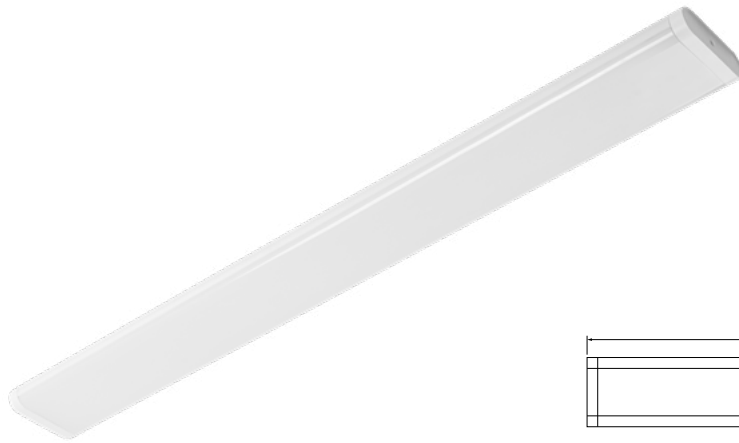

LED  
COMBINATION...



24-48 W

3  
years  
warranty

Technische  
und industrieleuchten



LD-LNG24WB-NB	24 W	● 4000 K	2400 lm	aluminium, PC aluminio, PC	600 × 130 × 42	blanc, blanco, weiβ, bijeli	PF > 0,5	800 g	5902801374876
LD-LNG48WB-NB	48 W		4800 lm	Aluminium, PC aluminij, PC	1200 × 130 × 42		PF > 0,9	1600 g	5902801330803

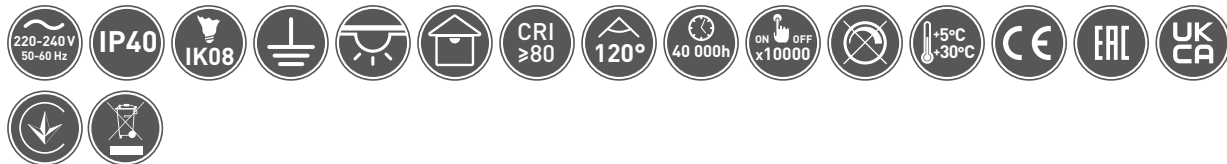

FR Luminaire LED monté en applique  
ES Luminarias LED de superficie  
DE Aufputz-LED-Leuchte  
HR LED nadgradna svjetiljka

## ZEFIR PRO

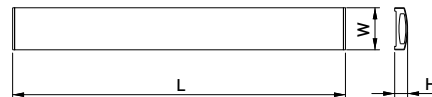

LED  
COMBINATION...



24-48 W

4  
years  
warranty



LD-ZFPL24W06-NB	24 W	● 4000 K	2200 lm	aluminium, aluminio,	591 × 148,5 × 52,5	blanc, blanco, weiβ, bijeli	PF > 0,5	825 g	5902801218170
LD-ZFPL48W12-NB	48 W		4400 lm	Aluminium, aluminij	1191 × 148,5 × 52,5		PF > 0,9	1475 g	5902801278624

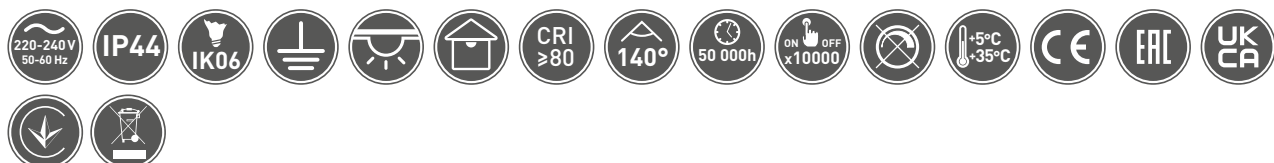

FR Luminaire LED monté en applique  
ES Luminarias LED de superficie  
DE Aufputz-LED-Leuchte  
HR LED nadgradna svjetiljka

## ASPEN

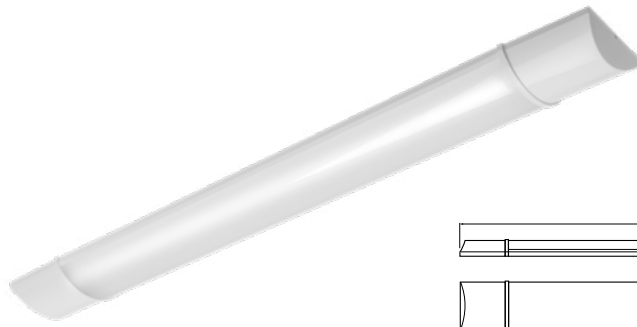

LD-OLL20W-CB	20 W	● 3000 K	1800 lm	PC	600 × 68 × 23	blanc, blanco, weiß, bijeli	PF > 0,5	190 g	5902801284151
LD-OLL20W-NB		● 4000 K							5902801010453
LD-OLL40W-CB	40 W	● 3000 K	3600 lm		1200 × 68 × 23		PF > 0,9	360 g	5902801285011
LD-OLL40W-NB		● 4000 K							5902801010460
LD-OLL50W-CB	50 W	● 3000 K	4500 lm		1500 × 68 × 23		PF > 0,9	475 g	5902801284274
LD-OLL50W-NB		● 4000 K							5902801010477



FR Luminaire LED hermétique  
ES Luminaria LED hermética  
DE Hermetische Leuchte LED  
HR LED vodotjesna svjetiljka

## ONTARIO

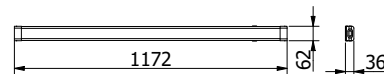

LD-ONT120-36	36 W	max 4	● 4000 K	3600 lm	PC	blanc, blanco, weiß, bijeli	470 g	5902801247255
--------------	------	-------	----------	---------	----	--------------------------------------	-------	---------------

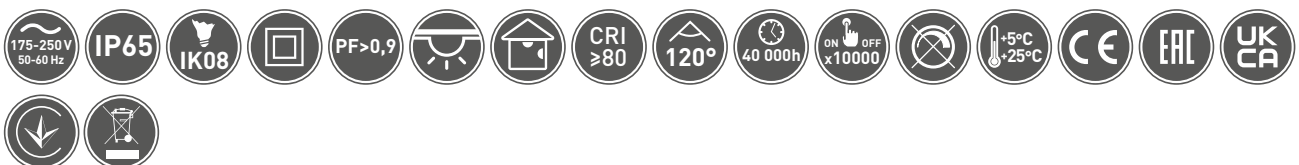

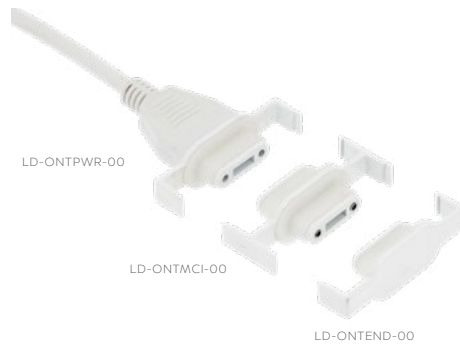

LD-ONTEND-00		20 g	5902801247453
LD-ONTMCI-00	blanc, blanco, weiß, bijeli	30 g	5902801245060
LD-ONTPWR-00		60 g	5902801245022







PLAFONNIER LED  
PLAFONES Y LUMINARIAS PARA SÓTANOS  
DECKEN- UND FEUCHTRAUM-/AUSSENLEUCHTEN  
LED PLAFONJERE I BRODSKE SVJETILJKE

FR Plafonnier LED  
ES Plafón LED  
DE LED-Deckenleuchte  
HR LED plafonjera

**BESA**

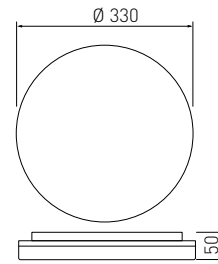
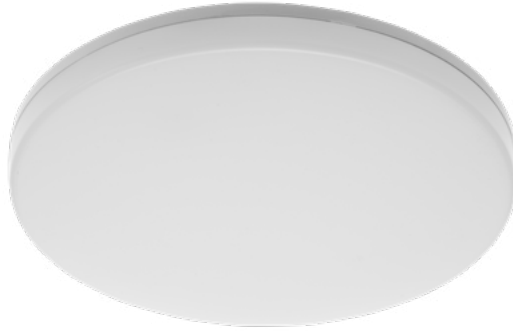

24 W



Technische  
und industrielleuchten



LD-BES24WOK-30	24 W	● 3000 K	2400 lm	PC	blanc, blanco, weiß, bijeli	880 g	5902801289255
LD-BES24WOK-40		● 4000 K					5902801041532

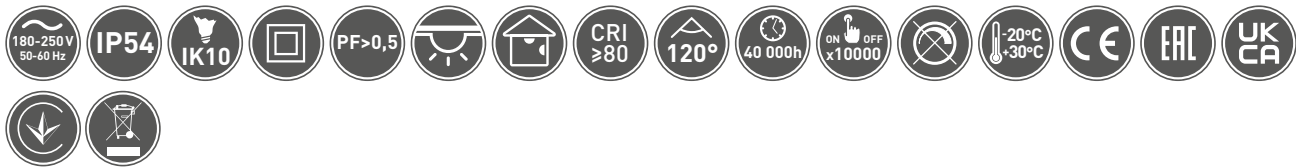

FR Plafonnier LED  
ES Plafón LED  
DE LED-Deckenleuchte  
HR LED plafonjera

**BESA**

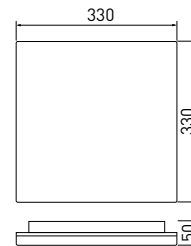

24 W



LD-BES24WKW-30	24 W	● 3000 K	2400 lm	PC	blanc, blanco, weiß, bijeli	880 g	5902801289385
LD-BES24WKW-40		● 4000 K					5902801041891

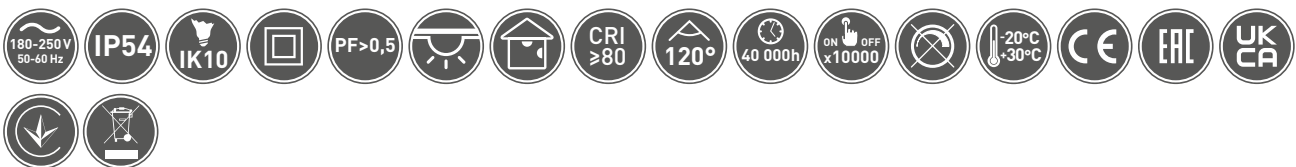

FR Plafonnier LED  
ES Plafón LED  
DE LED-Deckenleuchte  
HR LED plafonjera



24-48 W



## STARS BIS

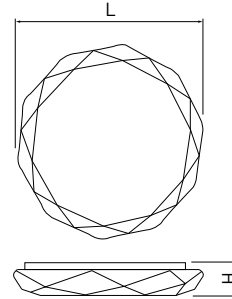
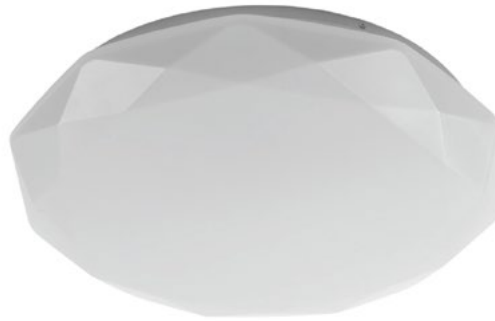

Technische  
und industrielleuchten



LD-STARS24W-NW-00	24 W	● 4000 K	1920 lm	PC	410x105	0,5	1160 g	5902801392139
LD-STARS48W-NW-00	48 W		3840 lm		510x110	0,9	2520 g	5902801326127



FR Plafonnier LED  
ES Plafón LED  
DE LED-Deckenleuchte  
HR LED plafonjera

## MOON

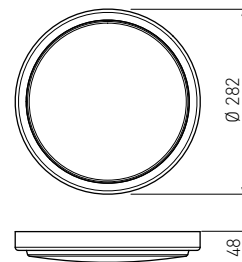
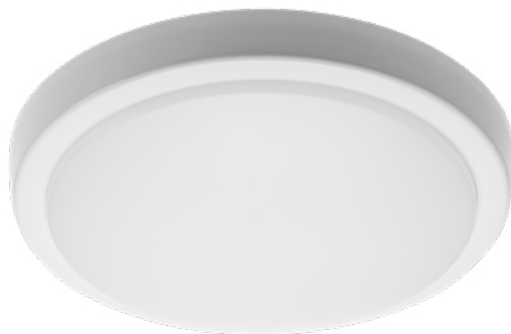

12-18 W



LD-MOON12W-NB	12 W	● 4000 K	1200 lm	PC/PC	blanc, blanco, weiß, bijeli	630 g	5902801219443
LD-MOON18W-NB	18 W		1800 lm				5902801219498







FR Plafonnier LED  
ES Plafón LED  
DE LED-Deckenleuchte  
HR LED plafonjera



20-30 W



## FENIX



Technische  
und industrielleuchten



LD-FEN20W-NW-00	20W	● 4000 K	2000 lm	Acrylique acrílico, Acryl, akril	blanc, blanco, weiß, bijeli	300x83	0,5	850 g	5902801326318
LD-FEN30W-NW-00	30W		3000 lm			345x83	0,9	900 g	



FR Plafonnier LED  
ES Plafón LED  
DE LED-Deckenleuchte  
HR LED plafonjera



12-48 W



## SATURN BIS



LD-SATU12W-NW-00	12 W	● 4000 K	960lm	Acrylique acrílico, Acryl, akril	blanc, blanco, weiß, bijeli	245x59	0,5	550 g	5902801391958
LD-SATU18W-NW-00	18 W		1440lm			315x59		860 g	5902801391941
LD-SATU24W-NW-00	24 W		1920lm			375x59		1190 g	5902801392146
LD-SATU32W-NW-00	32 W		2560 lm			375x59	0,9	1400 g	5902801367045
LD-SATU48W-NW-00	48 W		4020lm			475x59		2430 g	5902801334269



FR Plafonnier LED  
ES Plafón LED  
DE LED-Deckenleuchte  
HR LED plafonjera

## SATURN

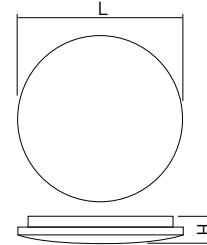

LED  
controllable



12-24 W



Technische  
und industrielleuchten



LD-SATU12WM-NB	12 W	● 4000 K	IP 44	900 lm	ø245 × 59	Acrylique acrílico, Acryl, akril	blanc, blanco, weiß, bijeli	390 g	5902801285134
LD-SATU18WM-NB	18 W			1300 lm	ø290 × 61			520 g	5902801285264
LD-SATU24WM-NB	24 W			1600 lm	ø315 × 67			660 g	5902801285110



FR Plafonnier LED  
ES Plafón LED  
DE LED-Deckenleuchte  
HR LED plafonjera

## ATOL

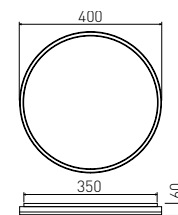

**NEW**

LED  
controllable



32 W



LD-ATOL32W-NW-10	32 W	● 4000 K	2560 lm	Acrylique acrílico, Acryl, akril	noir, negro, schwarz, crna	1400 g	5902801392122
LD-ATOL32W-WW-10		● 3000 K					5902801366703
LD-ATOL32W-NW-02		● 4000 K			inox, inox, inox, inox		5902801350283
LD-ATOL32W-WW-02		● 3000 K					5902801366512
LD-ATOL32W-NW-40		● 4000 K			blanc/Or, blanco/oro, weiß/gold, bijeli/zlato		5902801350207
LD-ATOL32W-WW-40		● 3000 K					5902801366550



FR Plafonnier LED  
ES Plafón LED  
DE LED-Deckenleuchte  
HR LED plafonjera

LED  
TECHNOLOGY



22 W



Technische  
und industrielleuchten



## TOKIO

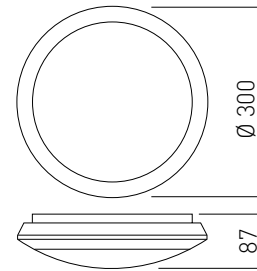

LD-TOK22W-40	22 W	● 4000 K	2000 lm	PC / PC	blanc, blanco, weiß, bijeli	1000 g	5902801283888
--------------	------	----------	---------	---------	--------------------------------------	--------	---------------

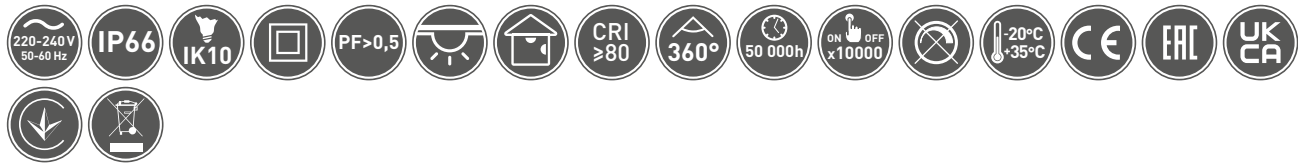

FR Plafonnier LED avec détecteur crépusculaire à micro-ondes  
ES Plafón LED con sensor microondas crepuscular  
DE LED Plafonnier mit einem Dämmerungsschalter  
HR LED plafonjera sa senzorom nivoa osvjetljenosti

LED  
TECHNOLOGY



16 W



## TOKIO

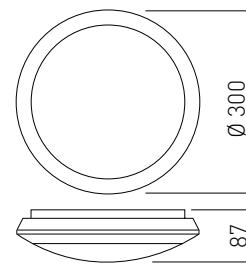

LD-TOK16WP-40	16 W	● 4000 K	1200 lm	PC/PC	blanc, blanco, weiß, bijeli	1000 g	5902801001840
---------------	------	----------	---------	-------	--------------------------------------	--------	---------------

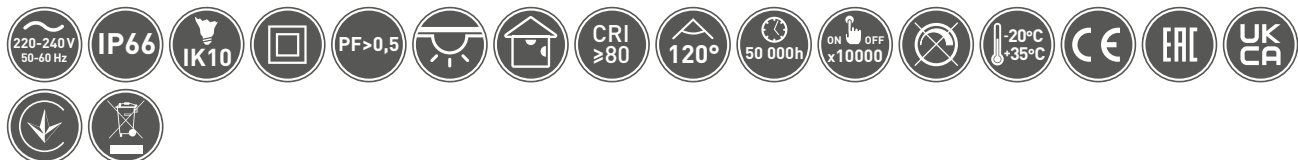

FR Plafonnier LED avec détecteur de mouvement à micro-ondes  
 ES Plafón LED con detector de movimiento por microondas  
 DE LED Plafonnier mit einem Mikrowellenbewegungssensor  
 HR LED plafonjera s mikrovalnim senzorom pokreta

**TOKIO**

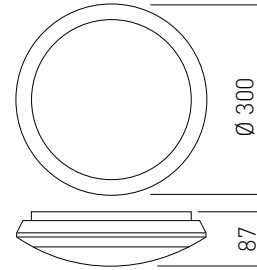

inside  
 16-22 W

motion sensor  
 100%  
 20%  
 0%  
 4 years warranty

Technische  
und industrielleuchten

LD-TOK16WD-40	16 W	● 4000 K	1200 lm	PC/PC	blanc, blanco, weiß, bijeli	1000 g	5902801001840
LD-TOK22WD-40	22 W		2000 lm				5902801001826

220-240 V 50-60 Hz IP66 IK10 PF>0,5 CRI ≥80 120° 360° 2-8 m 50 000h ON/OFF x10000 -20°C +35°C CE EAC UK CA

FR Plafonnier LED avec détecteur de mouvement à micro-ondes  
 ES Plafón LED con detector de movimiento por microondas  
 DE LED Plafonnier mit einem Mikrowellenbewegungssensor  
 HR LED plafonjera s mikrovalnim senzorom pokreta

**OSAKA**

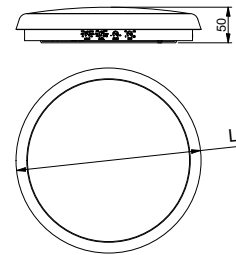

inside  
 16-22 W

microwave sensor  
 100%  
 20%  
 0%  
 4 years warranty

LD-OSA16WD-40	16 W	● 4000 K	1450 lm	PC/PC	ø260	blanc, blanco, weiß, bijeli	880 g	5902801284892
LD-OSA22WD-40	22 W		2000 lm		ø300		920 g	5902801282188

220-240 V 50-60 Hz IP54 IK10 PF>0,5 CRI ≥80 120° 360° 50 000h ON/OFF x10000 +5°C +30°C CE EAC UK CA





FR Plafonnier LED avec détecteur de mouvement à micro-ondes  
 ES Plafón LED con detector de movimiento por microondas  
 DE LED-Deckenleuchte mit Mikrowellenbewegungsmelder  
 HR LED plafonjera s mikrovalnim senzorom pokreta

**ASTI**

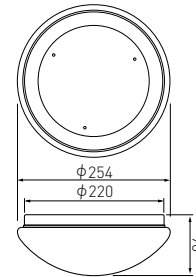
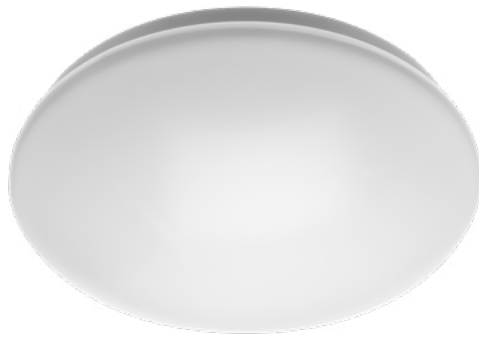

13 W



Technische  
und industrieleuchten



LD-ASTID13-NW-00	13 W	4000 K	1100 lm	Plastique, plastico, Kunststoff, plastika	blanc, blanco, weiß, bijeli	450 g	5902801360558



FR Plafonnier LED  
 ES Plafón LED  
 DE LED-Deckenleuchte  
 HR LED plafonjera

**ASTRA**

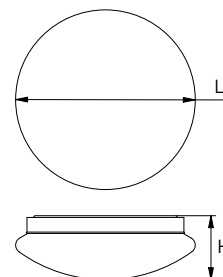

12-24 W



LD-ASTR12W-NW-00	12W	4000 K	960lm	Acrylique acrílico, Acryl, akril	blanc, blanco, weiß, bijeli	245x59	530g	5902801391934
LD-ASTR18W-NW-00	18W		1440lm			315x59	880g	5902801391354
LD-ASTR24W-NW-00	24W		1920lm			375x59	1180g	5902801391965



FR Plafonnier LED avec détecteur de mouvement à micro-ondes  
 ES Plafón LED con detector de movimiento por microondas  
 DE LED-Deckenleuchte mit Mikrowellenbewegungsmelder  
 HR LED plafonjera s mikrovalnim senzorom pokreta



12-24 W



**ASTRA**

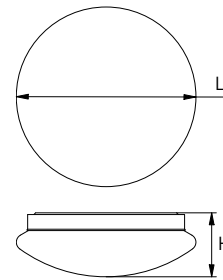

Technische  
und industrielleuchten



LD-ASTR12WM-NW-00	12W	● 4000 K	960lm	Acrylique acrílico, Acryl, akril	blanc, blanco, weiß, bijeli	245x59	600 g	5902801392177
LD-ASTR18WM-NW-00	18W		1440lm			315x59	950 g	5902801350221
LD-ASTR24WM-NW-00	24W		1920lm			375x59	1250 g	5902801350238

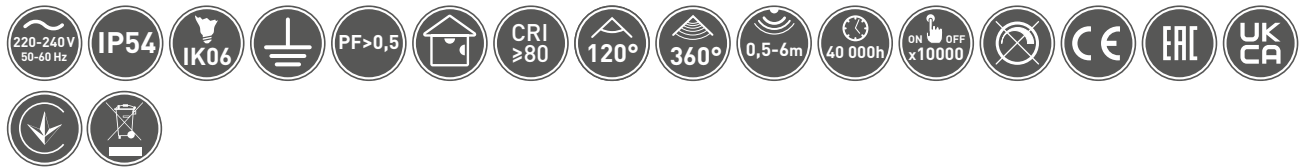

FR Plafonnier LED avec détecteur de mouvement  
 ES Plafón LED con detector de movimiento  
 DE LED-Deckenleuchte mit Bewegungsmelder  
 HR LED plafonjera s senzorom pokreta



16 W



**LOGOS**

360°

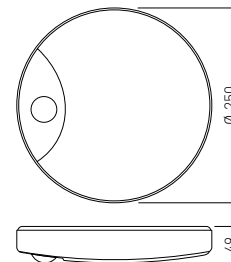

LD-LOG16W-LED	16 W	● 4000 K	1200 lm	Plastique, plastico, Kunststoff, plastika	blanc, blanco, weiß, bijeli	508 g	5901867197085
---------------	------	----------	---------	--	--------------------------------------	-------	---------------



FR Plafonnier LED avec détecteur crépusculaire  
 ES Plafón LED con sensor crepuscular  
 DE LED Plafonnier mit einem Dämmerungsschalter  
 HR LED svjetiljka sa senzorum nivoa osvjetljenosti

## MACARI

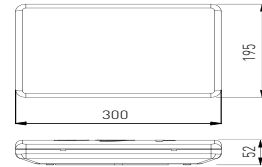

Jeu de lettres et de chiffres inclus.  
 Conjunto de letras y números incluidos.  
 Satz Buchstaben und Zahlen enthalten.  
 Skup slova i brojeva u Prilogu



12 W



Technische  
und industrieleuchten



LD-MCR12W-NB	12 W	● 4000 K	950 lm	PC	blanc, blanco, weiß, bijeli	680 g	5902801294143





FR Plafonnier LED avec détecteur de mouvement  
ES Plafón LED con detector de movimiento  
DE LED-Deckenleuchte mit Bewegungsmelder  
HR LED plafonjera s senzorom pokreta

ITALIA

Technische  
und industrieleuchten



OS-ITL12W-LED	12 W	● 4000 K	900 lm	PC	blanc, blanco, weiß, bijeli	560 g	5901867158291
OS-ITL16W-LED	16 W		1200 lm				5901867197016



FR Plafonnier LED avec détecteur de mouvement  
ES Plafón LED con detector de movimiento  
DE LED-Deckenleuchte mit Bewegungsmelder  
HR LED plafonjera s senzorom pokreta

ITALIA



OS-ITL12WKW-LED	12 W	● 4000 K	900 lm	PC	blanc, blanco, weiß, bijeli	420 g	5902801282089

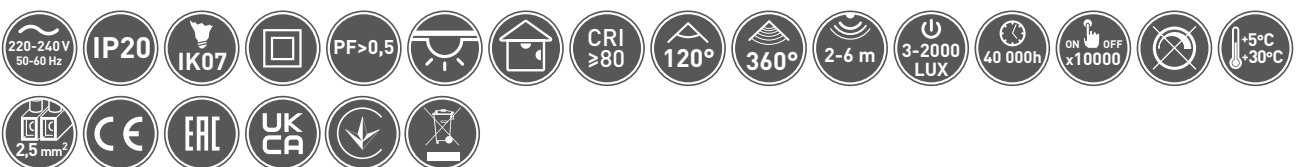

FR Plafonnier local technique  
ES Luminaria para sótanos  
DE Robuste Wand-/Deckenleuchte LED  
HR LED brodska svjetiljka

**LUXIA**

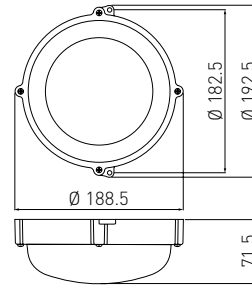

LD-KALU100K-40	10 W	● 4000 K	700 lm	PC / PC	blanc, blanco, weiß, bijeli	250 g	5901867169204
----------------	------	----------	--------	---------	--------------------------------------	-------	---------------



Technische  
und industrieleuchten

FR Plafonnier local technique  
ES Luminaria para sótanos  
DE Robuste Wand-/Deckenleuchte LED  
HR LED brodska svjetiljka

**LUXIA**

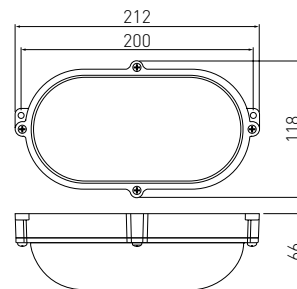

LD-KALU100W-40	10 W	● 4000 K	700 lm	PC / PC	blanc, blanco, weiß, bijeli	250 g	5901867169228
----------------	------	----------	--------	---------	--------------------------------------	-------	---------------



FR Plafonnier local technique  
 ES Luminaria para s6tanos  
 DE Robuste Wand-/Deckenleuchte LED  
 HR LED brodska svjetiljka



## TWIST

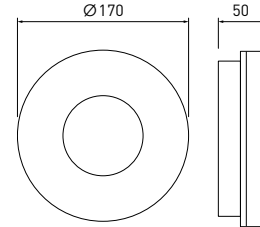

LD-TWI10WOK-40	10 W	● 4000 K	750 lm	PC	noir, negro, schwarz, crna	300 g	5902801041303
----------------	------	----------	--------	----	-------------------------------------	-------	---------------



FR Plafonnier local technique  
 ES Luminaria para s6tanos  
 DE Robuste Wand-/Deckenleuchte LED  
 HR LED brodska svjetiljka

## TWIST

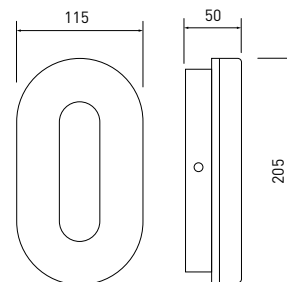

LD-TWI10WOW-40	10 W	● 4000 K	750 lm	PC	noir, negro, schwarz, crna	300 g	5902801042058
----------------	------	----------	--------	----	-------------------------------------	-------	---------------

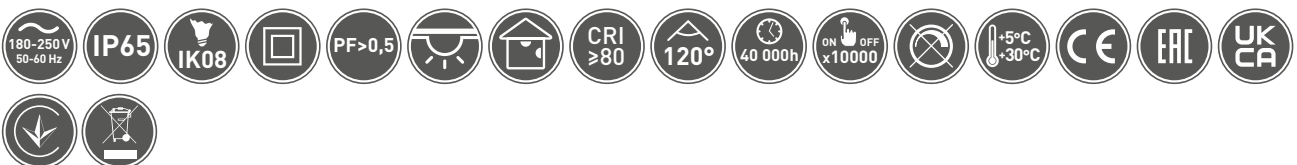







FR Plafonnier LED avec détecteur de mouvement pour local technique  
 ES Luminaria para sótanos LED con detector de movimiento  
 DE Robuste LED-Leuchte mit Bewegungsmelder  
 HR LED brodska svjetiljka sa senzorom pokreta



## DELTA

360°

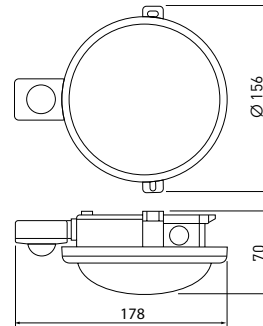

Technische  
und industrieleuchten



LD-DELOR6WC-NB

6 W

● 4000 K

400 lm

ABS / PC

blanc, blanco,  
weiß, bijeli

207 g

5901867191106



FR Plafonnier LED avec détecteur de mouvement pour local technique  
 ES Luminaria para sótanos LED con detector de movimiento  
 DE Robuste LED-Leuchte mit Bewegungsmelder  
 HR LED brodska svjetiljka sa senzorom pokreta

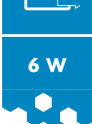

## DELTA

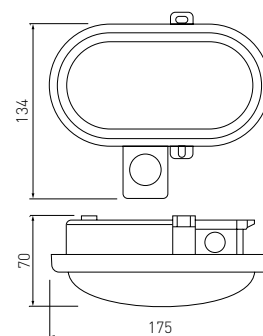

LD-DELOW6WC-NB

6 W

● 4000 K

400 lm

ABS / PC

blanc, blanco,  
weiß, bijeli

207 g

5901867191113

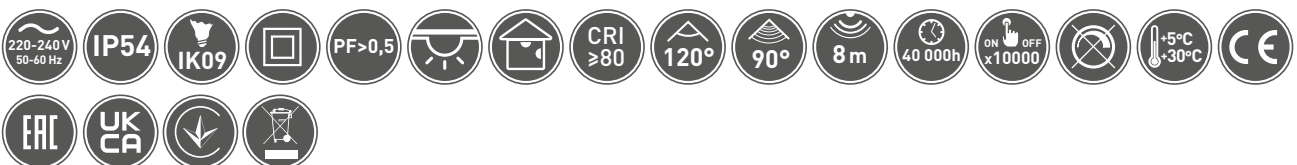

FR Plafonnier local technique  
 ES Luminaria para sótanos  
 DE Robuste Wand-/Deckenleuchte LED  
 HR LED brodska svjetiljka

**KODO**

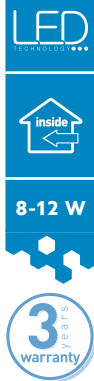
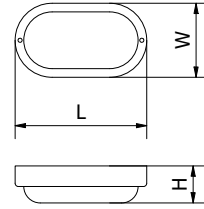

Technische  
und industrielleuchten



LD-KD08WOV-NB	8 W	● 4000 K	720 lm	PC	160 × 90 × 47	blanc, blanco, weiß, bijeli	220 g	5902801305269	
LD-KD12WOV-NB	12 W		1080 lm		197 × 97 × 47		250 g	5902801304798	

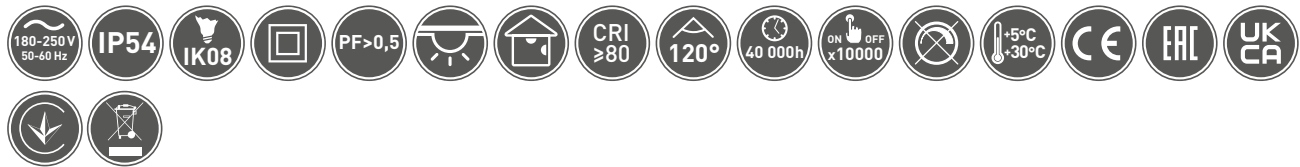

FR Plafonnier local technique  
 ES Luminaria para sótanos  
 DE Robuste Wand-/Deckenleuchte LED  
 HR LED brodska svjetiljka

**KODO**

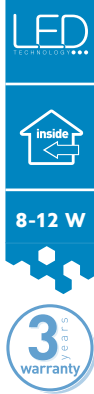
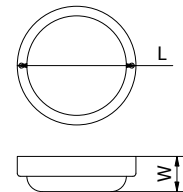

LD-KD08WOK-NB	8 W	● 4000 K	720 lm	PC	ø155 × 47	blanc, blanco, weiß, bijeli	240 g	5902801305276	
LD-KD12WOK-NB	12 W		1080 lm		ø175 × 47		280 g	5902801305153	

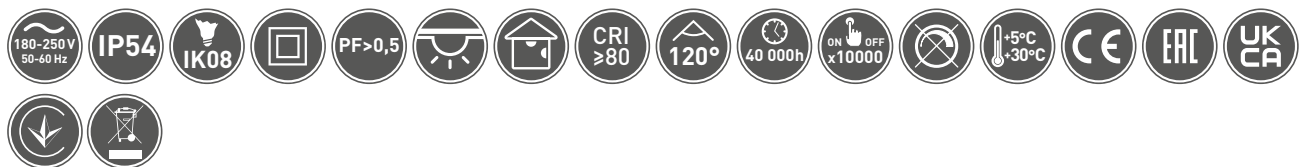



DOWNLIGHTS  
LUMINARIAS LED TIPO DOWNLIGHT  
DOWNLIGHT  
DOWNLIGHT LED SVJETILJK

FR Luminaire downlight LED encastrable  
 ES Luminaria LED de tipo downlight empotrable  
 DE Downlight-LED-Leuchte für Einlass-Montage  
 HR LED rasvjetno tijelo tipa downlight ugradbeno



12-24 W



**SORA**

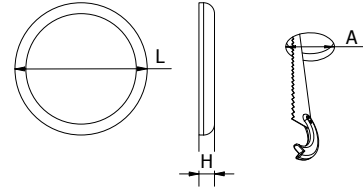
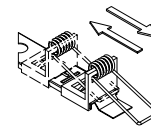

Model	Power (W)	Color Temp (K)	Beam Angle (°)	Material	Dimensions (mm)	Mounting Depth (mm)	PF	Weight (g)	Barcode
LD-SRW12WOK-NB	12 W	● 4000 K	1200 lm	PC	ø120 × 28	ø75-105	PF > 0,5	220 g	5902801305498
LD-SRW18WOK-NB	18 W		1800 lm		ø170 × 28	ø75-155		320 g	5902801305979
LD-SRW24WOK-NB	24 W		2400 lm		ø225 × 28	ø75-205		500 g	5902801306075



FR Luminaire downlight LED encastrable  
 ES Luminaria LED de tipo downlight empotrable  
 DE Downlight-LED-Leuchte für Einlass-Montage  
 HR LED rasvjetno tijelo tipa downlight ugradbeno



12-24 W



**SORA**

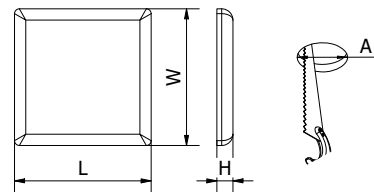
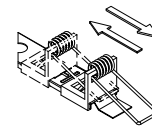

Model	Power (W)	Color Temp (K)	Beam Angle (°)	Material	Dimensions (mm)	Mounting Depth (mm)	PF	Weight (g)	Barcode
LD-SRW12WKW-NB	12 W	● 4000 K	1200 lm	PC	120 × 120 × 20	ø75-105	PF > 0,5	250 g	5902801306082
LD-SRW18WKW-NB	18 W		1800 lm		170 × 170 × 20	ø75-155		390 g	5902801305672
LD-SRW24WKW-NB	24 W		2400 lm		225 × 225 × 20	ø75-205		600 g	5902801307263

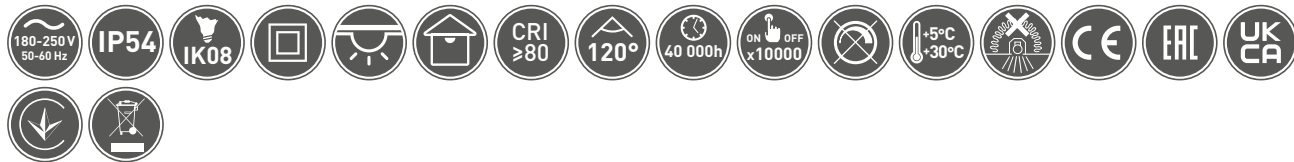

Technische  
und industrielleuchten



FR Luminaire downlight LED montage en applique  
 ES Luminaria LED de tipo downlight de superficie  
 DE Downlight-LED-Leuchte für Aufputzmontage  
 HR LED downlight nadgradna svjetiljka

## ORIS PLUS

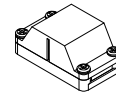
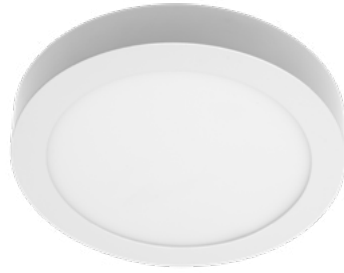

Accessoires  
 Accesorios  
 Zubehör  
 Dodatna oprema:  
 LZ-KO12KO-10

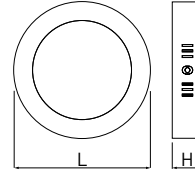

Technische  
 und industrieleuchten



LD-ORN07W-CBP	7 W	● 3000 K	560 lm	aluminium, aluminio, Aluminium, aluminij	ø120 x 32	PF > 0,5	340 g	5902801243080
LD-ORN07W-NBP		● 4000 K						5902801243271
LD-ORN13W-CBP	13 W	● 3000 K	1020 lm		ø170 x 32		490 g	5902801243486
LD-ORN13W-NBP		● 4000 K						5902801243028
LD-ORN19W-CBP	19 W	● 3000 K	1520 lm		ø224 x 32		610 g	5902801242779
LD-ORN19W-NBP		● 4000 K						5902801243523
LD-ORN24W-CBP	24 W	● 3000 K	2000 lm		ø303 x 32		1000 g	5902801243417
LD-ORN24W-NBP		● 4000 K						5902801243738



FR Luminaire downlight LED montage en applique  
 ES Luminaria LED de tipo downlight de superficie  
 DE Downlight-LED-Leuchte für Aufputzmontage  
 HR LED downlight nadgradna svjetiljka

**NEW**

## ORIS PLUS

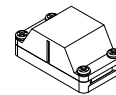

Accessoires  
 Accesorios  
 Zubehör  
 Dodatna oprema:  
 LZ-KO12KO-10

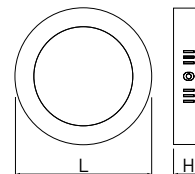

LD-ORN07W-CBP-10	7 W	● 3000 K	560 lm	aluminium, aluminio, Aluminium, aluminij	ø120 x 32	PF > 0,5	340 g	5902801387920
LD-ORN07W-NBP-10		● 4000 K						5902801387814
LD-ORN13W-CBP-10	13 W	● 3000 K	1020 lm		ø170 x 32		490 g	5902801388019
LD-ORN13W-NBP-10		● 4000 K						5902801388279
LD-ORN19W-CBP-10	19 W	● 3000 K	1520 lm		ø224 x 32		610 g	5902801388248
LD-ORN19W-NBP-10		● 4000 K						5902801399725
LD-ORN24W-CBP-10	24 W	● 3000 K	2000 lm		ø303 x 32		1000 g	5902801388361
LD-ORN24W-NBP-10		● 4000 K						5902801388378

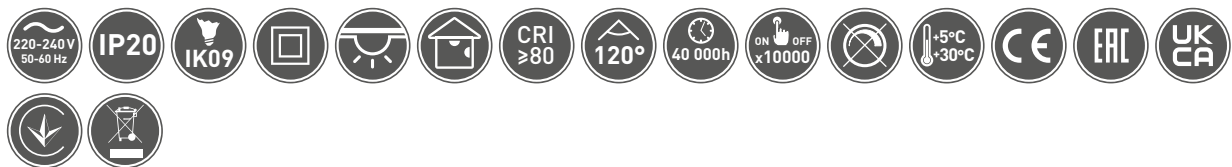

FR Luminaire downlight LED encastrable  
 ES Luminaria LED de tipo downlight empotrable  
 DE Downlight-LED-Leuchte für Einlass-Montage  
 HR LED rasvjetno tijelo tipa downlight ugradbeno



3-24 W

## ORIS PLUS

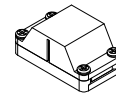
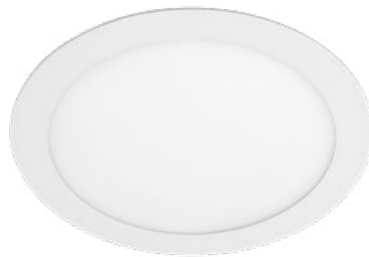

Accessoires  
 Accesorios  
 Zubehör  
 Dodatna oprema:  
 LZ-KOI2KO-10

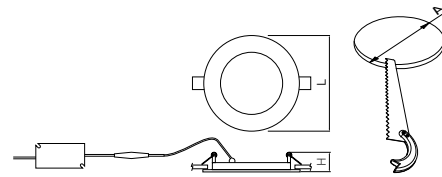

3 years warranty

IP20

	W	Color	lm	Material	LxH mm	A mm	PF	Weight	Barcode
LD-ORW03W-CBP	3 W	3000 K	200 lm	aluminium, aluminio, Aluminium, aluminij	ø90 x 22	ø72-75	PF > 0,5	150 g	5902801243066
LD-ORW03W-NBP		4000 K							5902801243318
LD-ORW07W-CBP	7 W	3000 K	560 lm		ø118 x 22	ø105-108		220 g	5902801243073
LD-ORW07W-NBP		4000 K							5902801243165
LD-ORW13W-CBP	13 W	3000 K	1020 lm		ø168 x 22	ø153-156		350 g	5902801243035
LD-ORW13W-NBP		4000 K							5902801243042
LD-ORW19W-CBP	19 W	3000 K	1520 lm		ø225 x 22	ø204-206		550 g	5902801243578
LD-ORW19W-NBP		4000 K							5902801243134
LD-ORW24W-CBP	24 W	3000 K	2000 lm		ø300 x 22	ø275-280		880 g	5901867127624
LD-ORW24W-NBP		4000 K							5901867158390



Technische und industrielleuchten

FR Luminaire downlight LED encastrable  
 ES Luminaria LED de tipo downlight empotrable  
 DE Downlight-LED-Leuchte für Einlass-Montage  
 HR LED rasvjetno tijelo tipa downlight ugradbeno



3-24 W

## ORIS PLUS

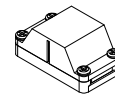

Accessoires  
 Accesorios  
 Zubehör  
 Dodatna oprema:  
 LZ-KOI2KO-10

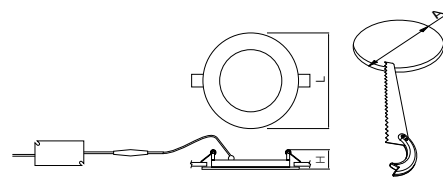

3 years warranty

IP44

	W	Color	lm	Material	LxH mm	A mm	PF	Weight	Barcode
LD-ORW03W-NBP4	3 W	3000 K	200 lm	aluminium, aluminio, Aluminium, aluminij	ø90 x 22	ø72-75	PF > 0,5	150 g	5902801267390
LD-ORW03W-CBP4		4000 K							5902801267352
LD-ORW07W-CBP4	7 W	3000 K	560 lm		ø118 x 22	ø105-108		220 g	5902801266430
LD-ORW07W-NBP4I		4000 K							5902801396847
LD-ORW13W-CBP4	13 W	3000 K	1020 lm		ø168 x 22	ø153-156		350 g	5902801266058
LD-ORW13W-NBP4		4000 K							5902801266737
LD-ORW19W-CBP4	19 W	3000 K	1520 lm		ø225 x 22	ø204-206		550 g	5902801266362
LD-ORW19W-NBP4		4000 K							5902801266713
LD-ORW24W-CBP4	24 W	3000 K	2000 lm		ø300 x 22	ø275-280		880 g	5902801266478
LD-ORW24W-NBP4		4000 K							5902801266966

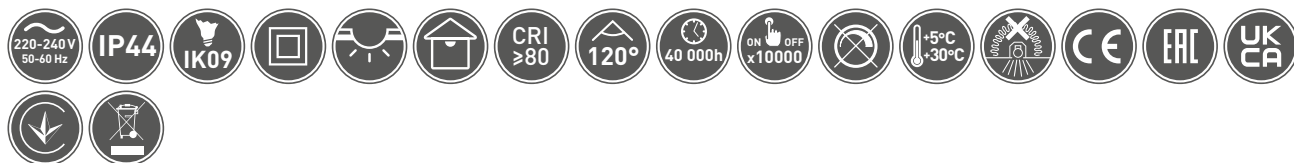

FR Luminaire LED encastrable  
ES Luminaria LED empotrable  
DE LED-Einbauleuchte  
HR LED rasvjetno tijelo ugradbeno

## ORIS PLUS

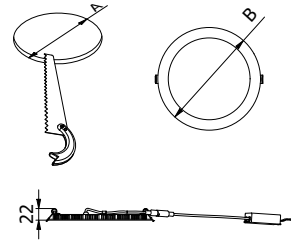
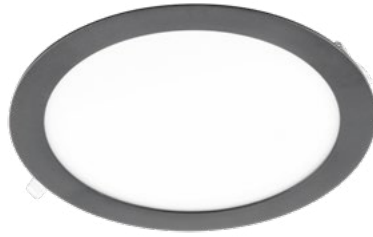

Technische  
und industrieleuchten

	W	Color	lm	Material	A	B	Weight	Barcode
LD-ORW07W-CBP-10	7 W	3000 K	560 lm	aluminium, aluminio, Aluminium, aluminij	Ø 105-108	Ø118	220 g	5902801399749
LD-ORW07W-NBP-10		4000 K						5902801399770
LD-ORW13W-CBP-10	13 W	3000 K	1020 lm		Ø 153-156	Ø168	350 g	5902801387845
LD-ORW13W-NBP-10		4000 K						5902801387937
LD-ORW19W-CBP-10	19 W	3000 K	1520 lm		Ø 204-206	Ø225	550 g	5902801387913
LD-ORW19W-NBP-10		4000 K						5902801387586
LD-ORW24W-CBP-10	24 W	3000 K	2000 lm		Ø 275-280	Ø300	880 g	5902801387869
LD-ORW24W-NBP-10		4000 K						5902801387876



FR Luminaire downlight LED montage en applique  
ES Luminaria LED de tipo downlight de superficie  
DE Downlight-LED-Leuchte für Aufputzmontage  
HR LED downlight nadgradna svjetiljka

## MATIS PLUS

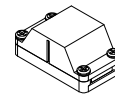

Accessoires  
Accesorios  
Zubehör  
Dodatna oprema:  
LZ-KOI2KO-10

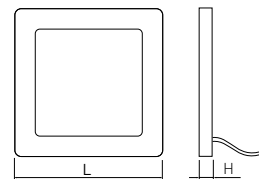

	W	Color	lm	Material	LxH mm	PF	Weight	Barcode
LD-MAN07W-CBP	7 W	3000 K	560 lm	aluminium, aluminio, Aluminium, aluminij	120 x 32	PF > 0,5	340 g	5902801244186
LD-MAN07W-NBP		4000 K						5902801244087
LD-MAN13W-CBP	13 W	3000 K	1020 lm		170 x 32		490 g	5902801244179
LD-MAN13W-NBP		4000 K						5902801244445
LD-MAN19W-CBP	19 W	3000 K	1520 lm		223 x 32		750 g	5902801244452
LD-MAN19W-NBP		4000 K						5902801244414
LD-MAN24W-CBP	24 W	3000 K	2000 lm		300 x 32		1300 g	5902801243776
LD-MAN24W-NBP		4000 K						5902801243332

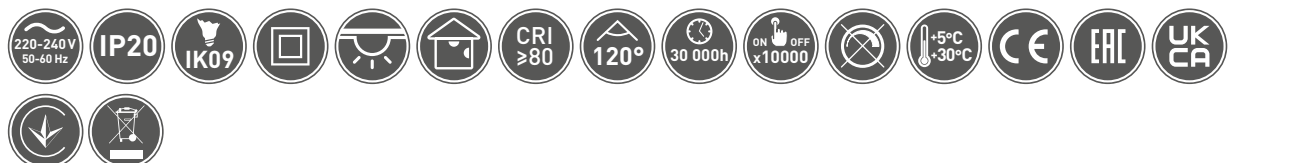

FR Luminaire downlight LED encastrable  
 ES Luminaria LED de tipo downlight empotrable  
 DE Downlight-LED-Leuchte für Einlass-Montage  
 HR LED rasvjetno tijelo tipa downlight ugradbeno

## MATIS PLUS

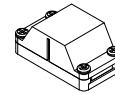

Accessoires  
 Accesorios  
 Zubehör  
 Dodatna oprema:  
 LZ-KOI2KO-10



3-24 W

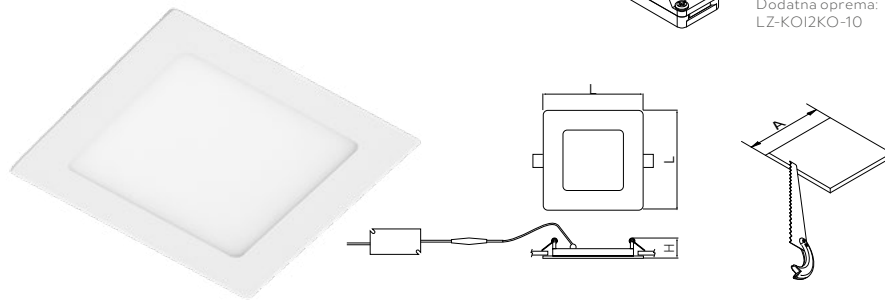

Model	Power (W)	Color Temp (K)	Light Output (lm)	Material	LxH (mm)	A (mm)	PF	Weight (g)	Barcode
LD-MAW03W-CBP	3 W	3000 K	200 lm	aluminium, aluminio, Aluminium, aluminij	86 x 22	72-75	PF > 0,5	150 g	5902801243448
LD-MAW03W-NBP		4000 K							5902801243653
LD-MAW07W-CBP	7 W	3000 K	560 lm		120 x 22	102-105		240 g	5902801243721
LD-MAW07W-NBP		4000 K							5902801243615
LD-MAW13W-CBP	13 W	3000 K	1020 lm		170 x 22	152-155		400 g	5902801243462
LD-MAW13W-NBP		4000 K							5902801243912
LD-MAW19W-CBP	19 W	3000 K	1520 lm		224 x 22	202-205		640 g	5902801243639
LD-MAW19W-NBP		4000 K							5902801243981
LD-MAW24W-CBP	24 W	3000 K	2000 lm		300 x 22	275-280		1100 g	5902801244155
LD-MAW24W-NBP		4000 K							5902801244056

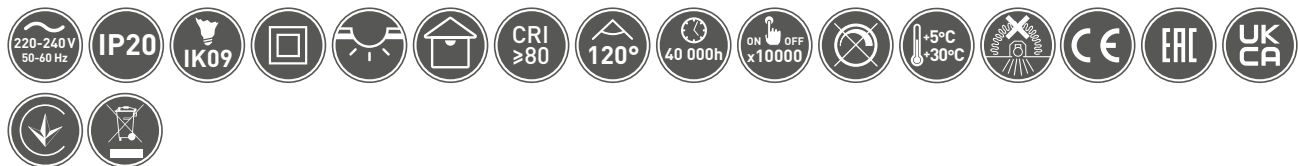

FR Luminaire downlight LED encastrable  
 ES Luminaria LED de tipo downlight empotrable  
 DE Downlight-LED-Leuchte für Einlass-Montage  
 HR LED rasvjetno tijelo tipa downlight ugradbeno

## MATIS PLUS

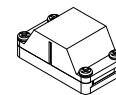

Accessoires  
 Accesorios  
 Zubehör  
 Dodatna oprema:  
 LZ-KOI2KO-10



3-24 W

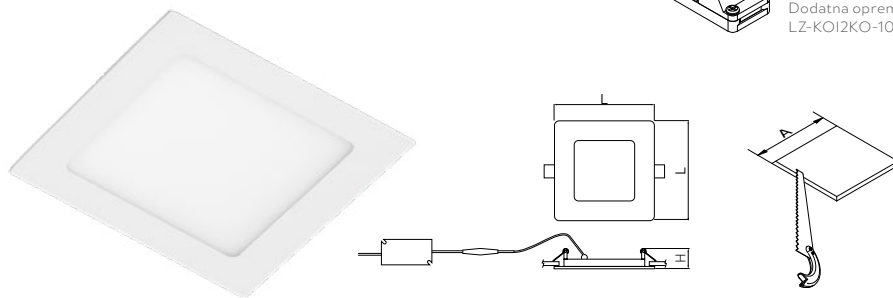

Model	Power (W)	Color Temp (K)	Light Output (lm)	Material	LxH (mm)	A (mm)	PF	Weight (g)	Barcode
LD-MAW03W-CBP4	3 W	3000 K	200 lm	aluminium, aluminio, Aluminium, aluminij	86 x 22	72-75	PF > 0,5	150 g	5902801267123
LD-MAW03W-NBP4		4000 K							5902801267567
LD-MAW07W-CBP4	7 W	3000 K	560 lm		120 x 22	102-105		240 g	5902801266447
LD-MAW07W-NBP4		4000 K							5902801266768
LD-MAW13W-CBP4	13 W	3000 K	1020 lm		170 x 22	152-155		400 g	5902801266720
LD-MAW13W-NBP4		4000 K							5902801267215
LD-MAW19W-CBP4	19 W	3000 K	1520 lm		224 x 22	202-205		640 g	5902801266706
LD-MAW19W-NBP4		4000 K							5902801266553
LD-MAW24W-NBP4	24 W	3000 K	2000 lm		300 x 22	275-280		1100 g	5902801267406
LD-MAW24W-CBP4		4000 K							5902801266492

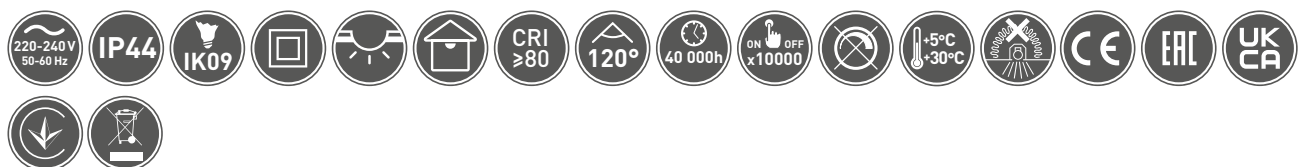



FR Luminaire downlight LED montage en applique  
 ES Luminaria LED de tipo downlight de superficie  
 DE Downlight-LED-Leuchte für Aufputzmontage  
 HR LED downlight nadgradna svjetiljka

## MATIS PLUS

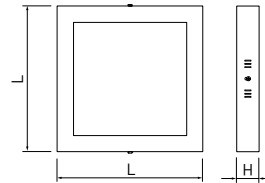

Technische  
und industrielleuchten



Model	Power (W)	Color Temp (K)	Lumen (lm)	Material	Dimensions (mm)	Weight (g)	Barcode
LD-MAN07W-CBP-10	7 W	3000 K	560 lm	aluminium, aluminio, Aluminium, aluminij	120 x 32	340g	5902801326752
LD-MAN07W-NBP-10		4000 K					5902801327162
LD-MAN13W-CBP-10	13 W	3000 K	1020 lm		170 x 32	490g	5902801327063
LD-MAN13W-NBP-10		4000 K					5902801333354
LD-MAN19W-CBP-10	19 W	3000 K	1520 lm		223 x 32	750g	5902801326714
LD-MAN19W-NBP-10		4000 K					5902801366949
LD-MAN24W-CBP-10	24 W	3000 K	2000 lm		300 x 32	1300g	5902801327285
LD-MAN24W-NBP-10		4000 K					5902801327346



FR Luminaire downlight LED encastrable  
 ES Luminaria LED de tipo downlight empotrable  
 DE Downlight-LED-Leuchte für Einlass-Montage  
 HR LED rasvjetno tijelo tipa downlight ugradbeno

## MATIS PLUS

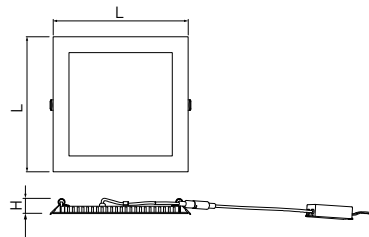
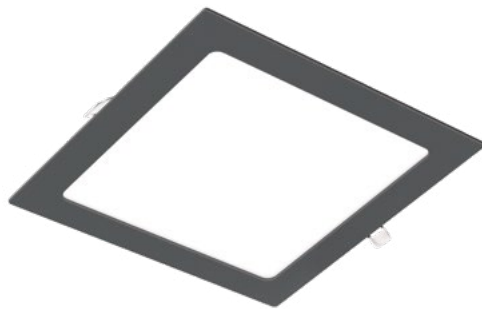

Model	Power (W)	Color Temp (K)	Lumen (lm)	Material	Dimensions (mm)	Weight (g)	Barcode	
LD-MAW07W-CBP-10	7 W	3000 K	560 lm	aluminium, aluminio, Aluminium, aluminij	120 x 22	102-105	240g	5902801266447
LD-MAW07W-NBP-10		4000 K						5902801266768
LD-MAW13W-CBP-10	13 W	3000 K	1020 lm		170 x 22	152-155	400g	5902801266720
LD-MAW13W-NBP-10		4000 K						5902801267215
LD-MAW19W-CBP-10	19 W	3000 K	1520 lm		224 x 22	202-205	640g	5902801266706
LD-MAW19W-NBP-10		4000 K						5902801266553
LD-MAW24W-CBP-10	24 W	3000 K	2000 lm		300 x 22	275-280	1100g	5902801267406
LD-MAW24W-NBP-10		4000 K						5902801266492



FR Luminaire downlight LED  
 ES Luminaria LED de tipo downlight  
 DE Downlight-LED-Leuchte  
 HR LED downlight svjetiljka

**MOZA**

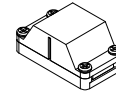
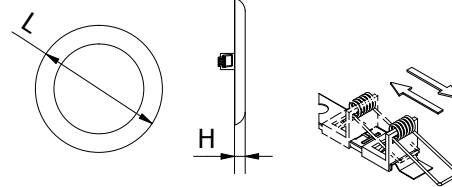
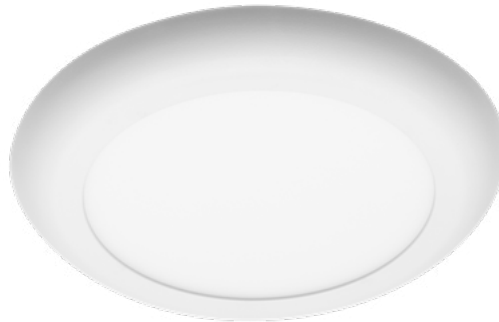

Accessoires  
 Accesorios  
 Zubehör  
 Dodatna oprema:  
 LZ-KOI2KO-10

**12-18 W**



LD-MZ12WOK-NB	12 W	● 4000 K	1000 lm	PC	ø180 × 16	ø65-155 mm	300 g	5902801229497
LD-MZ18WOK-NB	18 W		1500 lm		ø230 × 16	ø65-205 mm	390 g	5902801229329



FR Luminaire downlight LED  
 ES Luminaria LED de tipo downlight  
 DE Downlight-LED-Leuchte  
 HR LED downlight svjetiljka

**MOZA**

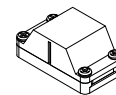
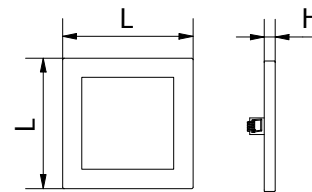

Accessoires  
 Accesorios  
 Zubehör  
 Dodatna oprema:  
 LZ-KOI2KO-10

**12-18 W**



LD-MZ12WKW-NB	12 W	● 4000 K	1000 lm	PC	180 × 16	ø65-155 mm	480 g	5902801229510
LD-MZ18WKW-NB	18 W		1500 lm		230 × 16	ø65-205 mm	570 g	5902801229428



FR Luminaire downlight LED montage en applique  
 ES Luminaria LED de tipo downlight de superficie  
 DE Downlight-LED-Leuchte für Aufputzmontage  
 HR LED downlight nadgradna svjetiljka



6-24 W



Technische  
und industrieleuchten

**LOUIS**

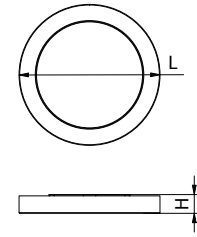
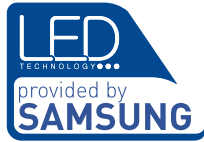

LD-LSNO06W-NB	6 W	● 4000 K	480 lm	aluminium, aluminio, Aluminium, aluminij	ø120 × 28	PF > 0,5	98 g	5902801226366
LD-LSNO12W-NB	12 W		960 lm		ø170 × 28		155 g	5902801226090
LD-LSNO24W-NB	24 W		1920 lm		ø225 × 28		274 g	5902801225819



FR Luminaire downlight LED montage en applique  
 ES Luminaria LED de tipo downlight de superficie  
 DE Downlight-LED-Leuchte für Aufputzmontage  
 HR LED downlight nadgradna svjetiljka



6-24 W



**LOUIS**

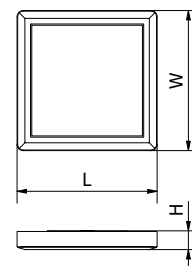

LD-LSNK06W-NB	6 W	● 4000 K	480 lm	aluminium, aluminio, Aluminium, aluminij	120 × 120 × 28	PF > 0,5	98 g	5902801226229
LD-LSNK12W-NB	12 W		960 lm		170 × 170 × 28		155 g	5902801226076
LD-LSNK24W-NB	24 W		1920 lm		225 × 225 × 28		274 g	5902801226533

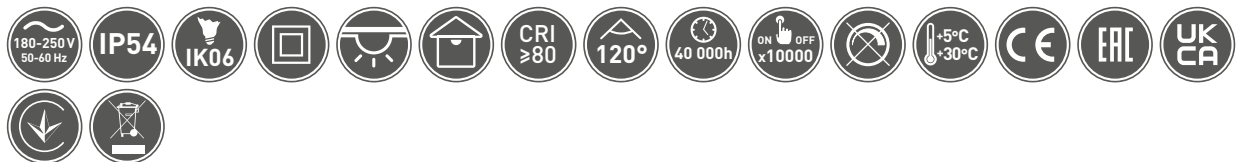







FR Luminaire downlight LED encastrable  
 ES Luminaria LED de tipo downlight empotrable  
 DE Downlight-LED-Leuchte für Einlass-Montage  
 HR LED rasvjetno tijelo tipa downlight ugradbeno



3-24 W



**LOUIS**

Technische  
und industrielleuchten

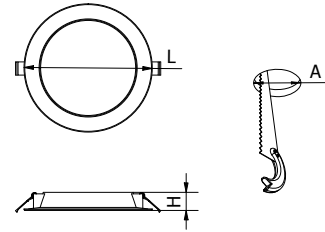
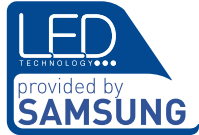

LD-LSWO03W-NB	3 W	● 4000 K	240 lm	PC	ø90 × 24	ø75	PF > 0,5	51 g	5902801226113
LD-LSWO06W-NB	6 W		480 lm		ø90 × 24	ø75		54 g	5902801226397
LD-LSWO15W-NB	15 W		1200 lm		ø150 × 24	ø135		133 g	5902801226373
LD-LSWO24W-NB	24 W		1920 lm		ø225 × 24	ø206		245 g	5902801225949

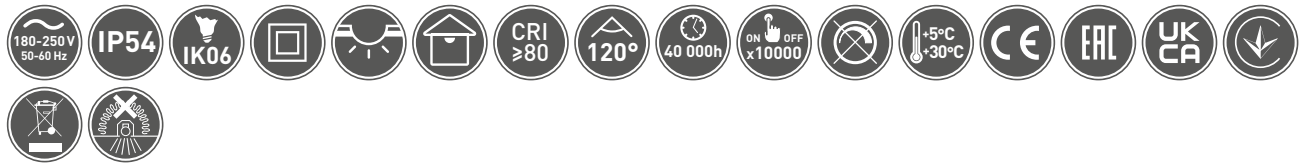

FR Luminaire downlight LED encastrable  
 ES Luminaria LED de tipo downlight empotrable  
 DE Downlight-LED-Leuchte für Einlass-Montage  
 HR LED rasvjetno tijelo tipa downlight ugradbeno



3-24 W



**LOUIS**

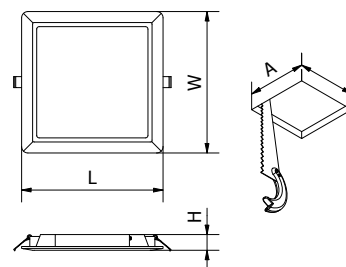

LD-LSWK03W-NB	3 W	● 4000 K	240 lm	PC	86 × 86 × 24	75	PF > 0,5	53 g	5902801226205
LD-LSWK06W-NB	6 W		480 lm		86 × 86 × 24	75		60 g	5902801225956
LD-LSWK15W-NB	15 W		1200 lm		150 × 150 × 24	135		148 g	5902801226427
LD-LSWK24W-NB	24 W		1920 lm		225 × 225 × 24	206		280 g	5902801226410

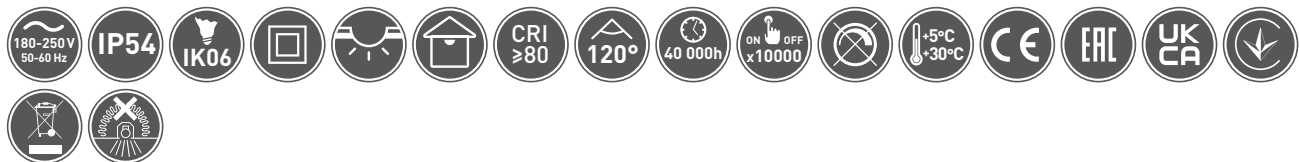

FR Luminaire downlight LED 2 en 1 montage en applique / encastrable  
 ES Luminaria LED de tipo downlight 2 en 1, de superficie / empotrable  
 DE LED-Einbauleuchten 2 in 1 Aufbau / Einbau  
 HR LED downlight ugradna/nadgradna svjetiljka 2 u 1

**SAMBA**

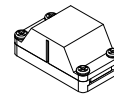
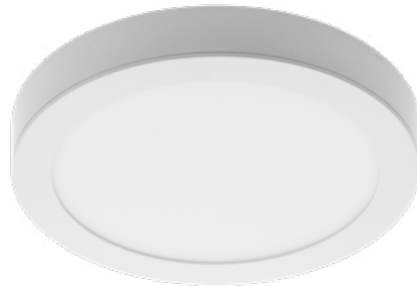

Accessoires  
 Accesorios  
 Zubehör  
 Dodatna oprema:  
 LZ-KOI2KO-10

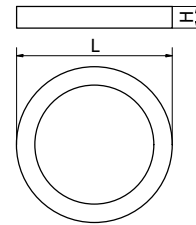

LD-SMBOK07W-21	7 W	● 4000 K	675 lm	PC	ø115 × 35	PF > 0,5	150 g	5902801240362
LD-SMBOK14W-21	14 W		1200 lm		ø177 × 35		300 g	5902801239946
LD-SMBOK20W-21	20 W		1600 lm		ø245 × 35		515 g	5902801073328



FR Luminaire downlight LED 2 en 1 montage en applique / encastrable  
 ES Luminaria LED de tipo downlight 2 en 1, de superficie / empotrable  
 DE LED-Einbauleuchten 2 in 1 Aufbau / Einbau  
 HR LED downlight ugradna/nadgradna svjetiljka 2 u 1

**SAMBA**

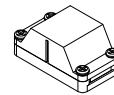
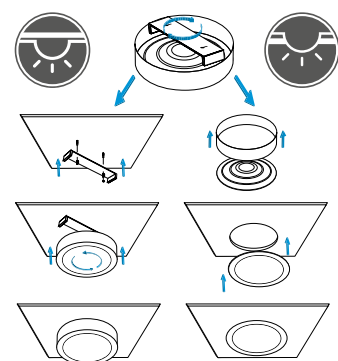

Accessoires  
 Accesorios  
 Zubehör  
 Dodatna oprema:  
 LZ-KOI2KO-10

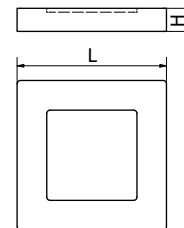

LD-SMBKW07W-21	9 W	● 4000 K	675 lm	PC	115 × 35	PF > 0,5	180 g	5902801239908
LD-SMBKW14W-21	16 W		1200 lm		171 × 35		365 g	5902801239861
LD-SMBKW24W-21	24 W		1800 lm		226 × 35		565 g	5902801073304



Technische  
und industrielleuchten

FR Luminaire downlight LED 2 en 1 montage en applique / encastrable  
 ES Luminaria LED de tipo downlight 2 en 1, de superficie / empotrable  
 DE LED-Einbauleuchten 2 in 1 Aufbau / Einbau  
 HR LED downlight ugradna/nadgradna svjetiljka 2 u 1

**BOLERO**

Technische  
und industrielleuchten

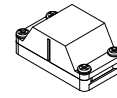
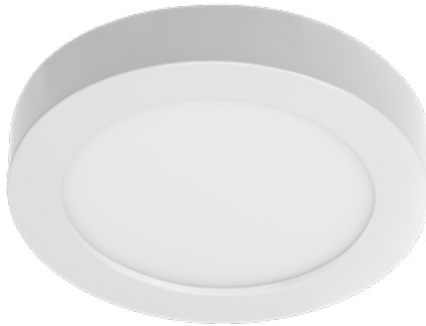
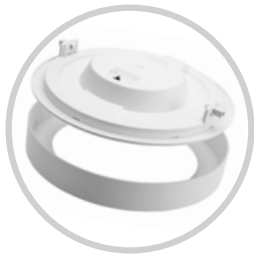

Accessoires  
 Accesorios  
 Zubehör  
 Dodatna oprema:  
 LZ-KOI2KO-10

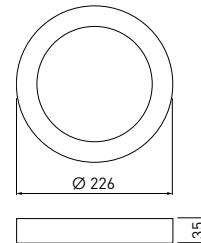

**18 W**

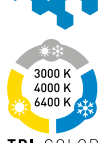

TRI-COLOR



LD-BLROK18W-61	18 W	<ul style="list-style-type: none"> <li>● 3000 K</li> <li>● 4000 K</li> <li>● 6400 K</li> </ul>	1600 lm	aluminium + PC, aluminio + PC, Aluminium + PC, aluminij + PC	560 g	5902801020117
----------------	------	--	---------	---	-------	---------------



FR Luminaire downlight LED 2 en 1 montage en applique / encastrable  
 ES Luminaria LED de tipo downlight 2 en 1, de superficie / empotrable  
 DE LED-Einbauleuchten 2 in 1 Aufbau / Einbau  
 HR LED downlight ugradna/nadgradna svjetiljka 2 u 1

**BOLERO**

360°

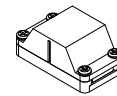
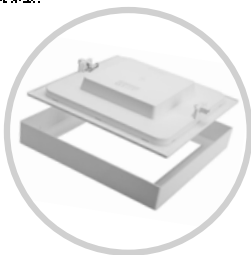

Accessoires  
 Accesorios  
 Zubehör  
 Dodatna oprema:  
 LZ-KOI2KO-10

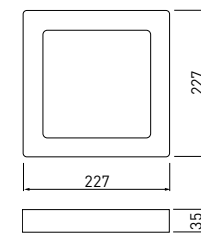

**18 W**



TRI-COLOR



LD-BLRKW18W-61	18 W	<ul style="list-style-type: none"> <li>● 3000 K</li> <li>● 4000 K</li> <li>● 6400 K</li> </ul>	1600 lm	aluminium + PC, aluminio + PC, Aluminium + PC, aluminij + PC	475 g	5902801020100
----------------	------	--	---------	---	-------	---------------



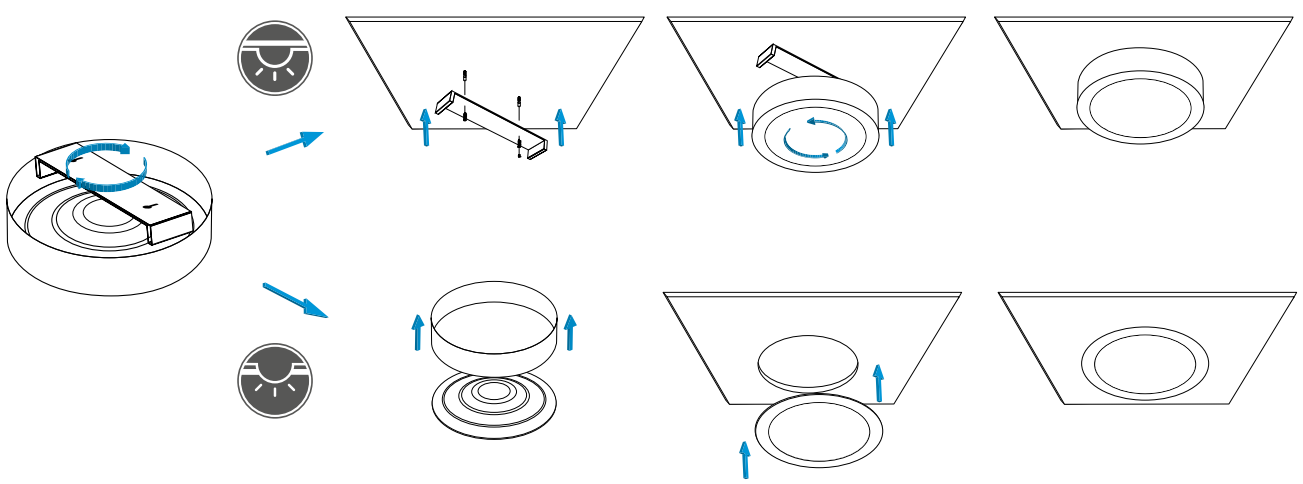
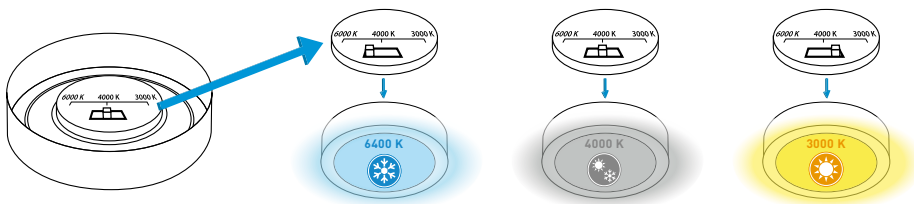



FR Luminaire downlight LED montage en applique  
 ES Luminaria LED de tipo downlight de superficie  
 DE Downlight-LED-Leuchte für Aufputzmontage  
 HR LED downlight nadgradna svjetiljka

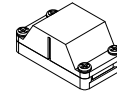

Accessoires  
 Accesorios  
 Zubehör  
 Dodatna oprema:  
 LZ-KOI2KO-10



**TWINS**

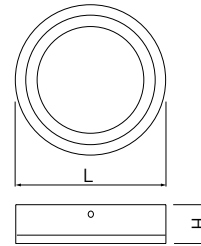
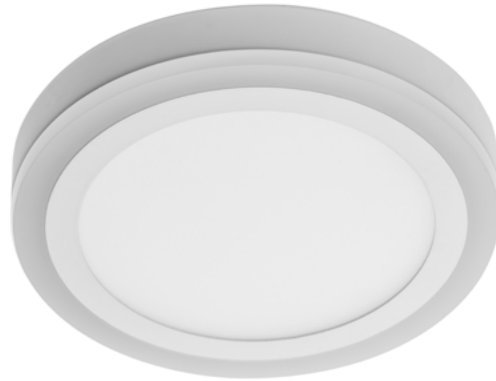

LD-TWN09W-CB	9 W (6W+3W)	3000 K	640 lm	aluminium + PC, aluminio + PC, Aluminium + PC, aluminij + PC	ø147 × 37	290 g	5901867191045
LD-TWN16W-CB	16 W (12W+4W)		1140 lm		ø195 × 37	480 g	5901867191052

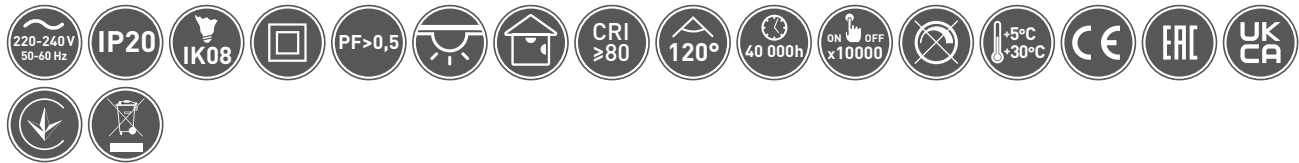

FR Luminaire downlight LED encastrable  
 ES Luminaria LED de tipo downlight empotrable  
 DE Downlight-LED-Leuchte für Einlass-Montage  
 HR LED rasvjetno tijelo tipa downlight ugradbeno

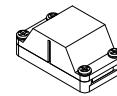

Accessoires  
 Accesorios  
 Zubehör  
 Dodatna oprema:  
 LZ-KOI2KO-10



**TWINS**

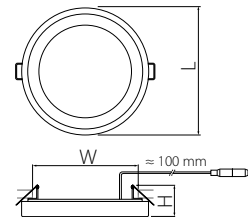

LD-TWW09W-CB	9 W (6W+3W)	3000 K	640 lm	aluminium + PC, aluminio + PC, Aluminium + PC, aluminij + PC	ø145 × 130 × 30	200 g	5901867191069
LD-TWW16W-CB	16 W (12W+4W)		1140 lm		ø190 × 175 × 30	324 g	5901867191076





OFF

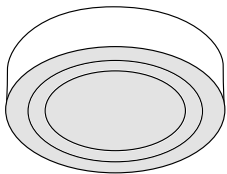

ON

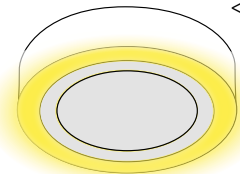

OFF  
<5 sek

ON

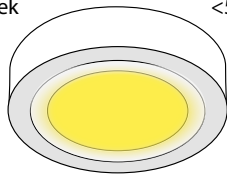

OFF  
<5 sek

ON

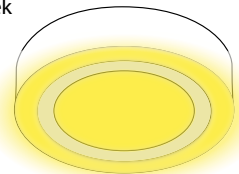

OFF >20 sek

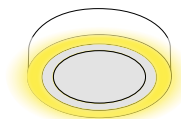

FR Luminaire downlight LED encastrable  
 ES Luminaria LED de tipo downlight empotrable  
 DE Downlight-LED-Leuchte für Einlass-Montage  
 HR LED rasvjetno tijelo tipa downlight ugradbeno

**VOLARE**

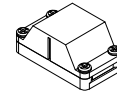

Accessoires  
 Accesorios  
 Zubehör  
 Dodatna oprema:  
 LZ-KO12KO-10

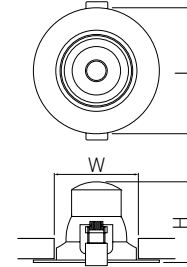
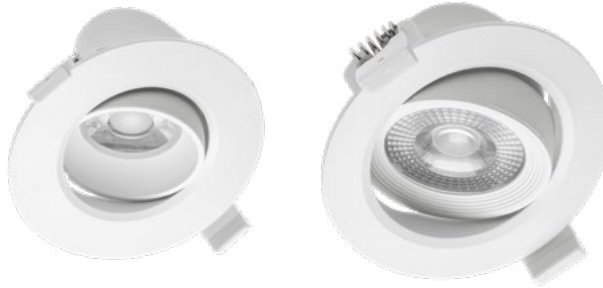

Technische  
und industrielleuchten



LD-VLROK0538-CB	5 W	● 3000 K	400 lm	ø90 × 75 × 45	PC	75 g	5902801015830
LD-VLROK0538-NB		● 4000 K					5902801299254
LD-VLROK1038-CB	10 W	● 3000 K	800 lm	ø104 × 80 × 60		120 g	5902801015885
LD-VLROK1038-NB		● 4000 K					5902801299438

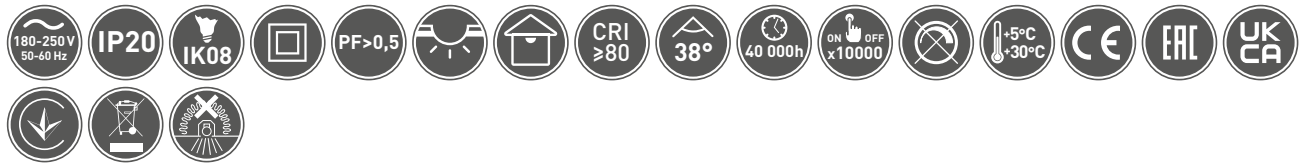

FR Luminaire downlight LED encastrable  
 ES Luminaria LED de tipo downlight empotrable  
 DE Downlight-LED-Leuchte für Einlass-Montage  
 HR LED rasvjetno tijelo tipa downlight ugradbeno

**VOLARE**

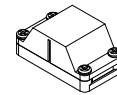

Accessoires  
 Accesorios  
 Zubehör  
 Dodatna oprema:  
 LZ-KO12KO-10

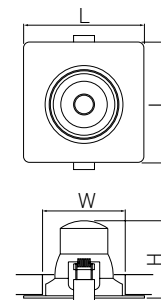

LD-VLRKW0538-CB	5 W	● 3000 K	400 lm	90 × 75 × 45	PC	75 g	5902801015823
LD-VLRKW0538-NB		● 4000 K					5902801299063
LD-VLRKW1038-CB	10 W	● 3000 K	800 lm	104 × 80 × 60		120 g	5902801015854
LD-VLRKW1038-NB		● 4000 K					5902801299353

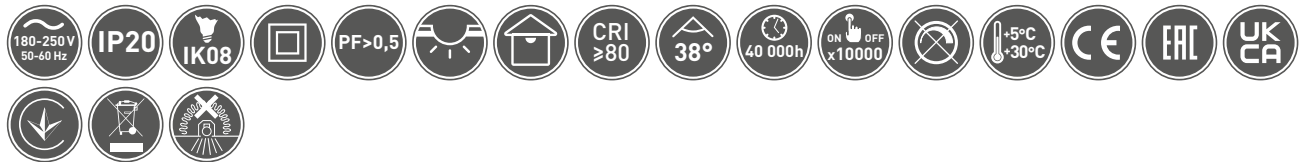

FR Luminaire downlight LED encastrable  
 ES Luminaria LED de tipo downlight empotrable  
 DE Downlight-LED-Leuchte für Einlass-Montage  
 HR LED rasvjetno tijelo tipa downlight ugradbeno

**VOLARE CCT**

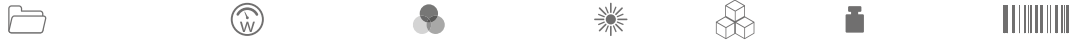
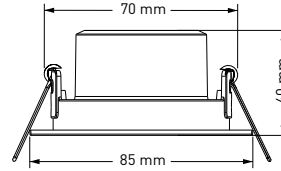

LD-VLROK0738-CCT	7 W	<ul style="list-style-type: none"> <li><span style="color: orange;">●</span> 3000 K</li> <li><span style="color: grey;">●</span> 4000 K</li> <li><span style="color: blue;">●</span> 6400 K</li> </ul>	630 lm	PC	100 g	5902801373060
------------------	-----	--	--------	----	-------	---------------

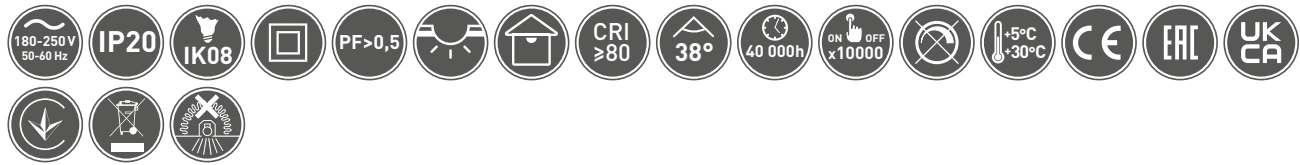

Technische und industrielleuchten

FR Luminaire downlight LED encastrable  
 ES Luminaria LED de tipo downlight empotrable  
 DE Downlight-LED-Leuchte für Einlass-Montage  
 HR LED rasvjetno tijelo tipa downlight ugradbeno

**VOLARE CCT**

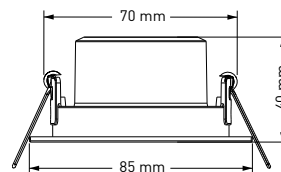

LD-VLRKW0738-CCT	7 W	<ul style="list-style-type: none"> <li><span style="color: orange;">●</span> 3000 K</li> <li><span style="color: grey;">●</span> 4000 K</li> <li><span style="color: blue;">●</span> 6400 K</li> </ul>	630 lm	PC	100 g	5902801373107
------------------	-----	--	--------	----	-------	---------------





FR Luminaire downlight LED encastrable  
 ES Luminaria LED de tipo downlight empotrable  
 DE Downlight-LED-Leuchte für Einlass-Montage  
 HR LED rasvjetno tijelo tipa downlight ugradbeno

## DENVER

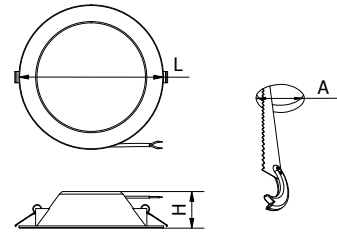

Technische  
und industrielleuchten

	W		lm		LxH mm	A mm	PF		
LD-DNV15W-NB	15 W	● 4000 K	1350 lm	PC	ø138 x 54	ø105	PF > 0,5	141 g	5902801226052
LD-DNV20W-NB	20 W		1800 lm		ø175 x 54	ø142			
LD-DNV30W-NB	30 W		2700 lm		ø225 x 54	ø180	PF > 0,9	331 g	



FR Luminaire downlight LED encastrable  
 ES Luminaria LED de tipo downlight empotrable  
 DE Downlight-LED-Leuchte für Einlass-Montage  
 HR LED rasvjetno tijelo tipa downlight ugradbeno

## AREZZO

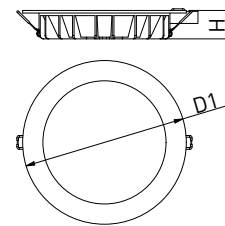

	W		lm		LxH mm		
LD-ARZ18W-CCT	18 W	● 3000 K ● 4000 K ● 6400 K	1800 lm	aluminium, aluminio, Aluminium, aluminij	ø145 x 30	500 g	5902801281884
LD-ARZ25W-CCT	25 W		2500 lm		ø190 x 30	525 g	5902801278112
LD-ARZ35W-CCT	35 W		3500 lm		ø225 x 30	660 g	5902801278136





FR Luminaire downlight LED montage en applique  
 ES Luminaria LED de tipo downlight de superficie  
 DE Downlight-LED-Leuchte für Aufputzmontage  
 HR LED downlight nadgradna svjetiljka

KARIS

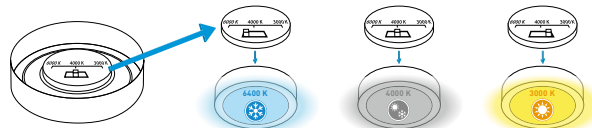
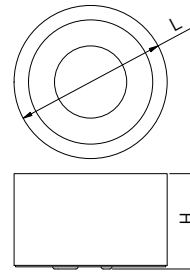

Technische  
und industrielleuchten

Folder	Wattage	Color Temperature	Beam Angle	Material	Dimensions (LxH mm)	Weight	Barcode
LD-KAR18W-CCT	18 W	● 3000 K ● 4000 K	1800 lm	aluminium, aluminio, Aluminium, aluminij	ø170 x 124	940 g	5902801210013
LD-KAR25W-CCT	25 W	● 6400 K	2500 lm		ø212 x 132	960 g	5902801210044

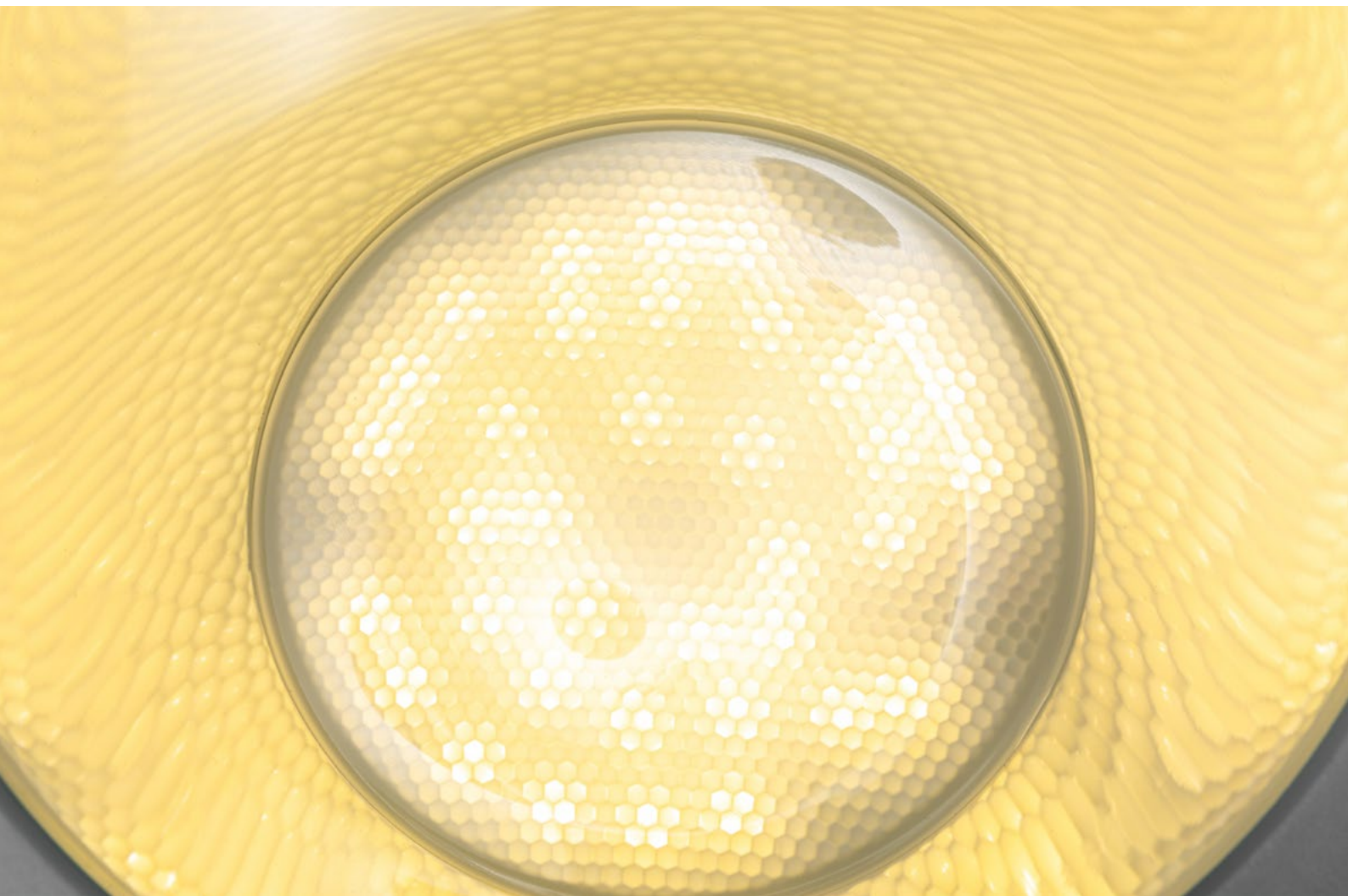



FR Luminaire downlight LED montage en applique  
 ES Luminaria LED de tipo downlight de superficie  
 DE Downlight-LED-Leuchte für Aufputzmontage  
 HR LED downlight nadgradna svjetiljka

## ARCCO

360°

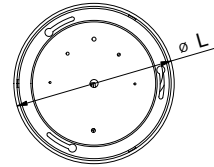

Technische  
und industrielleuchten



Folder	W	Color	Light	LxW mm	Material	Weight	Barcode
LD-ARC15W-NB	15 W	● 4000 K	1350 lm	ø130 × 100	aluminium, aluminio, Aluminium, aluminij	500 g	5902801278679
LD-ARC25W-NB	25 W		2250 lm	ø160 × 115		520 g	5902801278778
LD-ARC30W-NB	30 W		2700 lm	ø195 × 130		1000 g	5902801278747

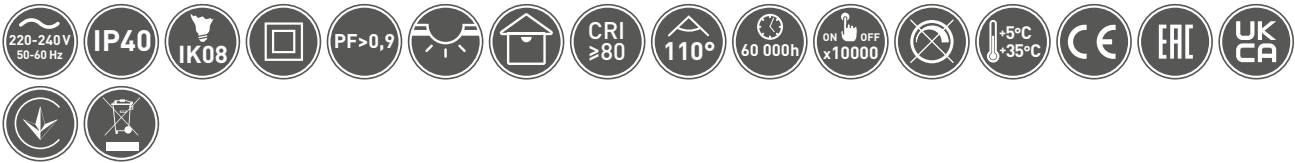





PROJECTEURS  
PROYECTORES LED  
LED FLUTLICHTSTARAHLER  
LED REFLEKTORI

FR Projecteur LED  
ES Proyector LED  
DE LED-Außenstrahler  
HR LED reflektor za osjačivanje

## DAYTONA

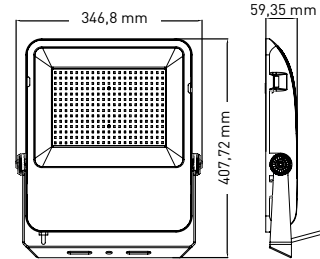

Technische  
und industrieleuchten



LD-DA200W-40	200 W	24000 lm	Verre + aluminium, vidrio + aluminio, Glas + Aluminium staklo + aluminij	noir, negro, schwarz, crna	4640 g	5902801327384
--------------	-------	----------	---	-------------------------------------	--------	---------------



FR Projecteur LED  
ES Proyector LED  
DE LED-Flutlichtstrahler  
HR LED reflektor

## VIPER

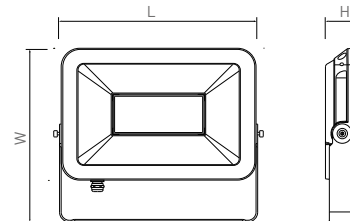

					LxWxH mm			
LD-VIPERS30W-40	30 W	● 4000 K	2700 lm	Verre + aluminium, vidrio + aluminio, Glas + Aluminium staklo + aluminij	198 x 191 x 34	noir, negro, schwarz, crna	860 g	5902801266195
LD-VIPERS50W-40	50 W		4500 lm		229 x 214 x 35		1150 g	5902801266263
LD-VIPERS100W-40	100 W		10000 lm		306 x 268 x 58		2200 g	5902801251764
LD-VIPERS150W-40	150 W		15000 lm		367 x 315 x 72		3500 g	5902801251771

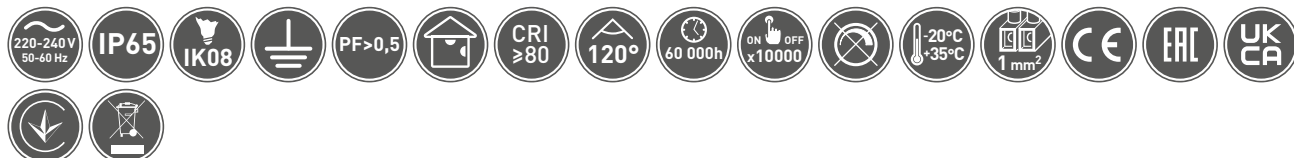

- FR Projecteur LED avec détecteur de mouvement
- ES Proyector LED con detector de movimiento
- DE LED-Flutlichtscheinwerfer mit Bewegungssensor
- HR LED reflektor sa senzorom pokreta



10-50 W



Technische  
und industrielleuchten

iNEXT

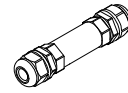

Accessoires  
Accesorios  
Zubehör  
Dodatna oprema  
WZL-2

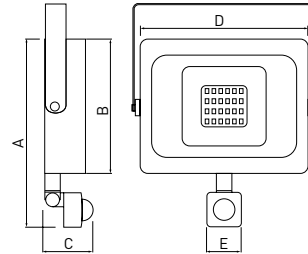

A × B × C × D × E  
(mm)



Model	Power (W)	Color Temp (K)	Beam Angle (lm)	Material	Dimensions (mm)	Color	Weight (g)	Barcode
LD-INEXT10W-64	10 W	6400 K	800 lm	Verre + aluminium, vidrio + aluminio, Glas + Aluminium staklo + aluminij	150 × 88 × 50 × 110 × 40	noir, negro, schwarz, crna	250 g	5902801007682
LD-INEXT20W-64	20 W		1600 lm		180 × 120 × 50 × 160 × 40		500 g	5902801007699
LD-INEXT30W-64	30 W		2400 lm		180 × 120 × 50 × 160 × 40		800 g	5902801007705
LD-INEXT50W-64	50 W		4000 lm		210 × 145 × 50 × 190 × 40		1200 g	5902801007712



- FR Projecteur LED
- ES Proyector LED
- DE LED-Flutlichtstrahler
- HR LED reflektor



30-50 W



iNEXT

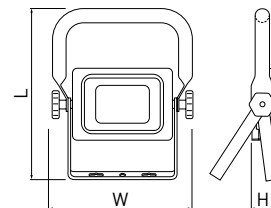

L×W×H  
mm



Model	Power (W)	Color Temp (K)	Beam Angle (lm)	Material	Dimensions (mm)	Color	Weight (g)	Barcode
LD-INEXT30WP-64	30 W	6400 K	2400 lm	Verre + aluminium, vidrio + aluminio, Glas + Aluminium staklo + aluminij	247 × 218 × 38	noir, negro, schwarz, crna	800 g	5902801007729
LD-INEXT50WP-64	50 W		4000 lm		270 × 256 × 38		1200 g	5902801007736

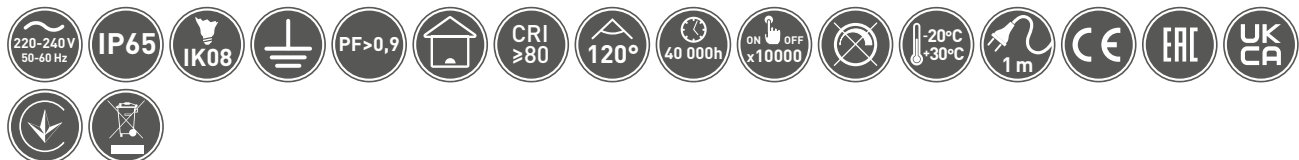







FR Projecteur LED  
ES Proyector LED  
DE LED-Flutlichtstrahler  
HR LED reflektor

iLUX

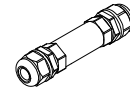

Accessoires  
Accesorios  
Zubehör  
Dodatna oprema:  
WZL-2

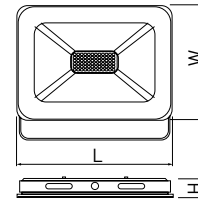

10-50 W



Technische  
und industrielleuchten



LD-ILUXC10W-64	10 W	6400 K	800 lm	>0,5	PC + Verre, PC + vidrio, PC + Glas, PC + staklo	128 x 92 x 31	blanc, blanco, weiß, bijeli	160 g	5901867191267
LD-ILUXCC10W-64							noir, negro, schwarz, crna		5902801005268
LD-ILUXC20W-64	20 W	6400 K	1600 lm	>0,5	PC + Verre, PC + vidrio, PC + Glas, PC + staklo	170 x 130 x 36	blanc, blanco, weiß, bijeli	470 g	5901867191243
LD-ILUXCC20W-64							noir, negro, schwarz, crna		5902801005282
LD-ILUXC30W-64I	30 W	6400 K	2400 lm	>0,9	PC + Verre, PC + vidrio, PC + Glas, PC + staklo	230 x 170 x 36	blanc, blanco, weiß, bijeli	780 g	5902801046865
LD-ILUXCC30W-64							noir, negro, schwarz, crna		5902801005305
LD-ILUXC50W-64	50 W	6400 K	4000 lm	>0,9	PC + Verre, PC + vidrio, PC + Glas, PC + staklo	300 x 220 x 36	blanc, blanco, weiß, bijeli	1230 g	5901867191229
LD-ILUXCC50W-64							noir, negro, schwarz, crna		5902801005329



FR Projecteur LED  
ES Proyector LED  
DE LED-Flutlichtstrahler  
HR LED reflektor

iLUX

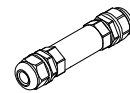

Accessoires  
Accesorios  
Zubehör  
Dodatna oprema:  
WZL-2

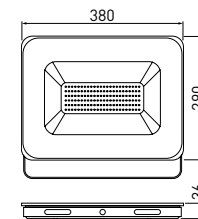

100 W



LD-ILUXC100W-64	100 W	6400 K	8000 lm	PC + Verre, PC + vidrio, PC + Glas, PC + staklo	blanc, blanco, weiß, bijeli	2000 g	5901867191267
LD-ILUXCC100W-64					noir, negro, schwarz, crna		5901867191243



FR Projecteur LED  
ES Proyector LED  
DE LED-Flutlichtstrahler  
HR LED reflektor

**ALLEDO**

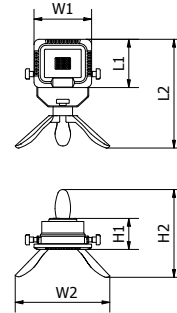

10-20 W



Technische  
und industrieleuchten



LD-ALCX10W-64	10 W	● 6400 K	800lm	-	Li-ion 4000 mAh 3,7 V	PC + Verre, PC + vidrio, PC + Glas, PC + staklo	87x228x108x213x58x180	vert, verde, grün, zelena	390 g	5902801330292
LD-ALCX20W-64*	20 W		1600lm	>0,5	Li-ion 4000 mAh 7,4 V		109x250x129x213x72x180		570 g	5902801330230



FR Projecteur LED  
ES Proyector LED  
DE LED-Flutlichtstrahler  
HR LED reflektor

**ONYX**

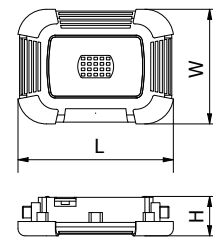

10-20 W



LD-OXCX10W-64	10 W	● 6400 K	800lm	Li-ion 4400 mAh 3,7 V	PC + Verre, PC + vidrio, PC + Glas, PC + staklo	173 x 128 x 44	bleu, azul, blau, plava	370 g	5902801343889
LD-OXCX20W-64	20 W		1600lm	Li-ion 8800 mAh 3,7 V				550 g	5902801330490







HIGH BAY LUMINAIRES LED  
LUMINARIAS LED TIPO HIGH BAY  
HIGHBAY LED-LEUCHTEN  
HIGH BAY LED SVJETILJKE



FR Réflecteur LED High-bay  
ES Foco industrial High-bay  
DE High-bay LED  
HR High-bay LED

## TEKSAS

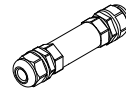
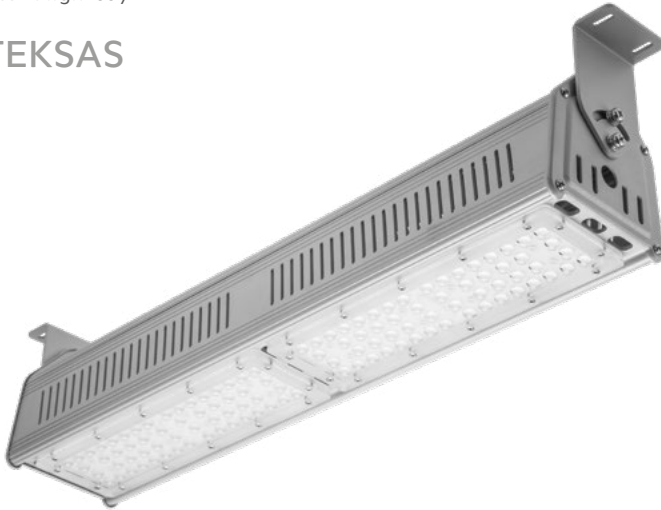

Accessoires  
Accesorios  
Zubehör  
Dodatna oprema:  
WZL-2

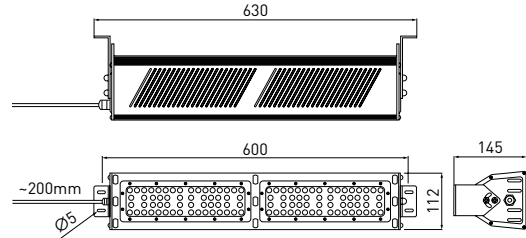

LD-TK100W-40	100 W	● 4000 K	12 000 lm	aluminium, aluminio, Aluminium, aluminij	gris, gris, grau, sivi	3000 g	5902801001970
--------------	-------	----------	-----------	---	------------------------	--------	---------------



FR Lentilles échangeables pour luminaire  
ES Lentes intercambiables  
DE Wechselobjektive  
HR Zamjenjiva leća



SO-TK060DE-00	60° x 60°	5902801008979
SO-TK090DE-00	90° x 90°	5902801008986
SO-TK612DE-00	60° x 120°	5902801008962
SO-TK069DE-00	60° x 90°	5902801024931



FR Réflecteur LED High-bay  
 ES Foco industrial High-bay  
 DE High-bay LED  
 HR High-bay LED

**ARIZONA**



**150 W**



Technische  
und industrielleuchten

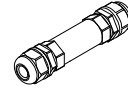

Accessoires  
 Accesorios  
 Zubehör  
 Dodatna oprema:  
 WZL-2

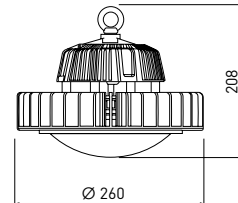

LD-HB150W-40	150 W	● 4000 K	18000 lm	aluminium, aluminio, Aluminium, aluminij	4500 g	5901867166432
--------------	-------	----------	----------	--	--------	---------------

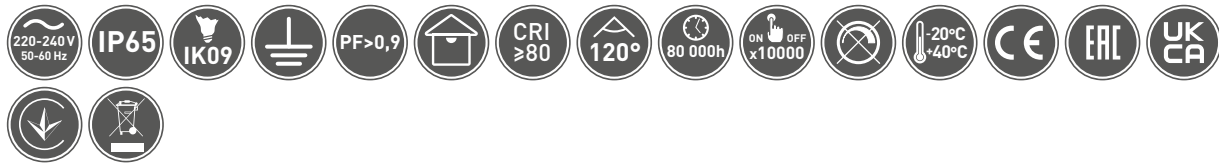

FR Réflecteur pour High-bay Arizona  
 ES Reflector para High-bay Arizona  
 DE Reflektor für Arizona-Highbay  
 HR Reflektor za High-bay Arizona

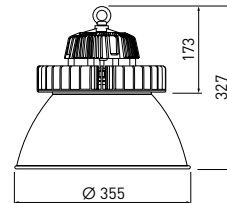

RF-HB150W-40	aluminium, aluminio, Aluminium, aluminij	gris, gris, grau, sivi	750 g	5901867170583
--------------	--	------------------------	-------	---------------





FR Réflecteur LED High-bay  
ES Foco industrial High-bay  
DE High-bay LED  
HR High-bay LED

## KANSAS

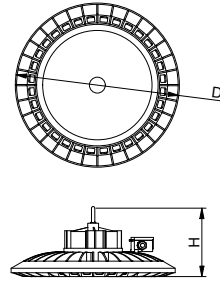

LED  
TECHNOLOGY



150-200 W



Technische  
und industrielleuchten



LD-KAN150W-NB	150 W	● 4000 K	19500 lm	aluminium, aluminio, Aluminium, aluminij	noir, negro, schwarz, crna	ø330 x 168	2700 g	5902801278815
LD-KAN200W-NB	200 W		26000 lm			ø390 x 179	3700 g	5902801279386



FR Réflecteur LED High-bay  
ES Foco industrial High-bay  
DE High-bay LED  
HR High-bay LED

## DALLAS

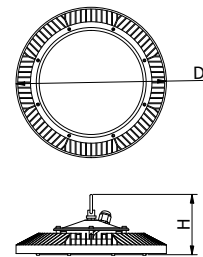

LED  
TECHNOLOGY



100-150 W



LD-DAL100W-NB	100 W	● 4000 K	10000 lm	aluminium, aluminio, Aluminium, aluminij	noir, negro, schwarz, crna	ø260 x 104	1600 g	5902801244988
LD-DAL150W-NB	150 W		15000 lm			ø300 x 120	2500 g	5902801247293

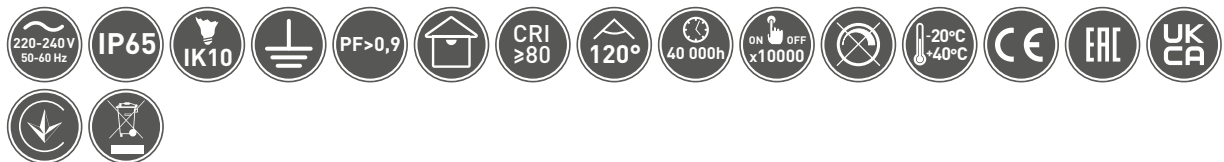









ECLAIRAGE PUBLIC  
LUMINARIAS LED DE PARA CALLES Y PARQUES  
STRASSEN- UND PARKLEUCHTEN LED  
LED ULIČNE SVJETILJKE



FR Lampe d'éclairage public  
ES Lámpara para calles y parques  
DE LED Straßen- und Parkplatzleuchte  
HR LED ulična svjetiljka

## PARKER III

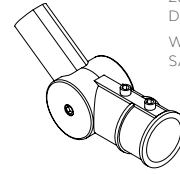
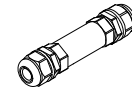

Accessoires  
Accesorios  
Zubehör  
Dodatna oprema:  
WZL-2  
SA1, SA2

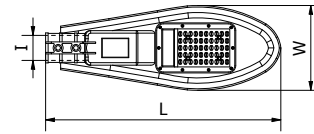

Model	Power (W)	Color Temp (K)	Beam Angle (lm)	Material	Dimensions (mm)	Power Factor (PF)	Weight (g)	Barcode
LD-PARK3L30W-40	30 W	4000 K	3000 lm	aluminium, aluminio, Aluminium, aluminij	470 x 170 x 75 x ø50	PF > 0,9	1050 g	5902801382444
LD-PARK3L50W-40	50 W		5000 lm				5902801377181	
LD-PARK3L80W-40	80 W		8000 lm		580 x 210 x 80 x ø65		2400 g	5902801378379



FR Adaptateur pour lampes d'éclairage public  
ES Adaptador para farolas de calles y parques  
DE Adapter für Straßen- und Parkleuchten  
HR Adapter za uličnu svjetiljku



SA1



SA2

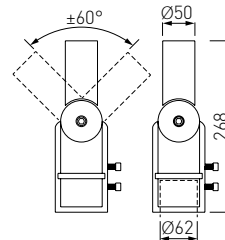

SA1

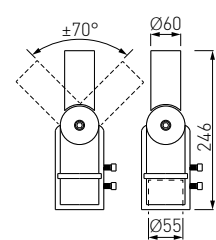

SA2



Model	Weight (g)	Barcode
SA1	680 g	5901867190840
SA2	550 g	5901867190864



FR Lampe d'éclairage public  
ES Lámpara para calles y parques  
DE LED Straßen- und Parkplatzleuchte  
HR LED ulična svjetiljka

Technische  
und industrielleuchten

## INDIANA

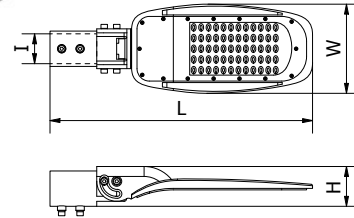

LxWxHxl  
mm



LD-IND60W-40	60 W	● 4000 K	7000 lm	aluminium, aluminio, Aluminium, aluminij	525 × 180 × 80 × ø60	5902801318351
LD-IND100W-40	100 W		13000 lm		580 × 220 × 80 × ø60	5902801324185
LD-IND150W-40	150 W		19500 lm		635 × 250 × 80 × ø60	5902801318467



FR Lampe d'éclairage public  
ES Lámpara para calles y parques  
DE LED Straßen- und Parkplatzleuchte  
HR LED ulična svjetiljka

## STELLA

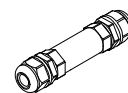

Accessoires  
Accesorios  
Zubehör  
Dodatna oprema:  
WZL-2

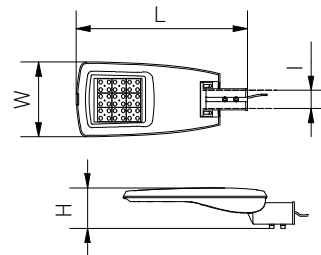

LxWxHxl  
mm



LD-STEL080W-40	80 W	● 4000 K	10400 lm	PF > 0,9	aluminium, aluminio, Aluminium, aluminij	610 × 256 × 145 × ø60	5000 g	5902801202179
LD-STEL150W-40	150 W		20300 lm			695 × 320 × 145 × ø60	7000 g	5902801202209









APPAREILS D'ÉCLAIRAGE D'URGENCE  
LUMINARIAS LED DE EMERGENCIA  
NOTBELEUCHTUNG  
PANIK LED LAMPE

FR Luminaria de red y alumbrado de emergencia LED  
 ES Adaptador para farolas de calles y parques  
 DE LED-Nothinweisleuchte  
 HR LED panik svjetiljka



## SAHER DUO

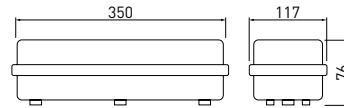

Technische  
und industrieleuchten

LD-SAHER1-DUO	3 W	1 h	6400 K	300 lm	PC	blanc, blanco, weiß, bijeli	805 g	5901867198280
LD-SAHER3-DUO		3 h					805 g	5901867198273

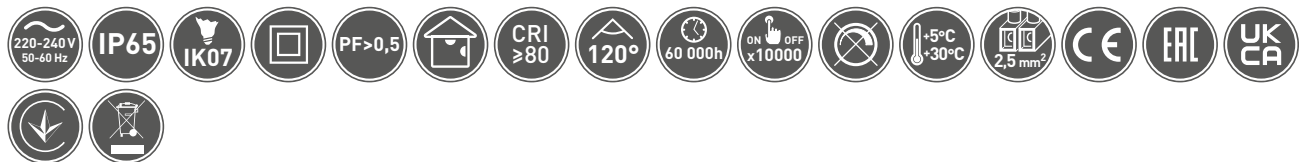

FR Luminaria de red y alumbrado de emergencia LED  
 ES Adaptador para farolas de calles y parques  
 DE LED-Nothinweisleuchte  
 HR LED panik svjetiljka



## TERNO

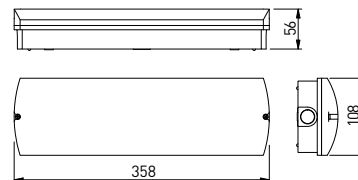

LD-TERNO1-00	3 W	1 h	6400 K	250 lm	PC	blanc, blanco, weiß, bijeli	600 g	5902801283338
LD-TERNO3-00		3 h						5902801284786

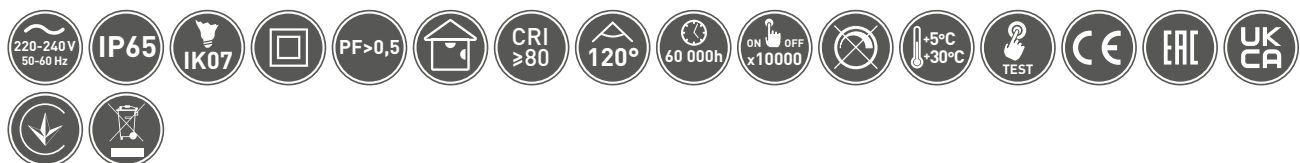

FR Luminaria de red y alumbrado de emergencia LED  
 ES Adaptador para farolas de calles y parques  
 DE LED-Nothinweisleuchte  
 HR LED panik svjetiljka



## SALED

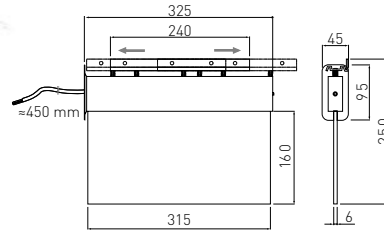

Technische  
und industrieleuchten



OA-SALED1-08	3 W	1 h	6400 K	aluminium, aluminio, Aluminium, aluminij	chrome, cromo, Chrom, krom	910 g	5908231370440
OA-SALED3-08		3 h				910 g	5908231301956

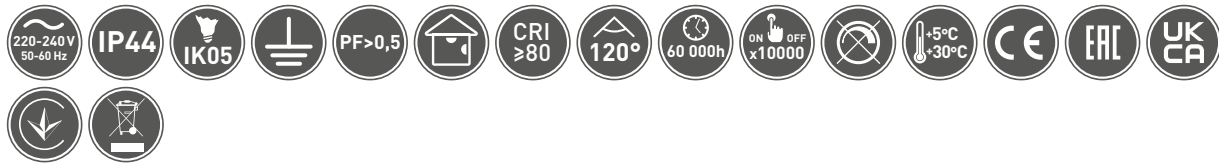

FR Luminaria de red y alumbrado de emergencia LED  
 ES Adaptador para farolas de calles y parques  
 DE LED-Nothinweisleuchte  
 HR LED panik svjetiljka



## CORSO

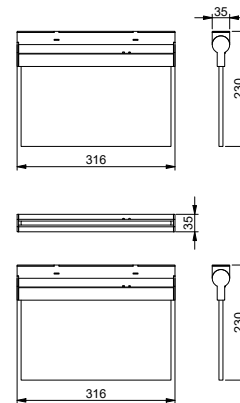

LD-CORSO1-00	3 W	1 h	6400 K	PC	blanc, blanco, weiß, bijeli	960 g	5902801284649
LD-CORSO3-00		3 h				960 g	5902801284908

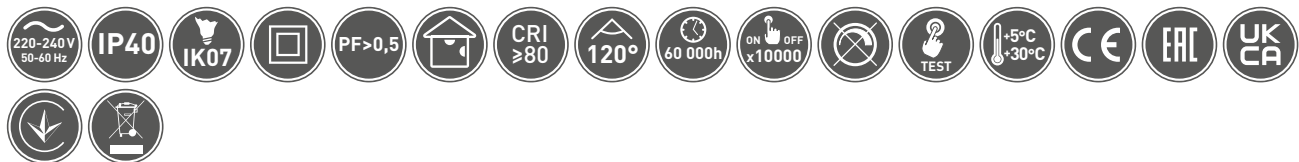

FR Luminaria de red y alumbrado de emergencia LED  
 ES Adaptador para farolas de calles y parques  
 DE LED-Nothinweisleuchte  
 HR LED panik svjetiljka

**OGLA**



White

Black

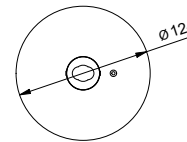
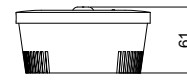

LD-OGLA3W-00	3 W	3 h	6400 K	200 lm	PC	blanc, blanco, weiß, bijeli	335 g	5902801284755
LD-OGLA3W-10						noir, negro, schwarz, crna		5902801326110

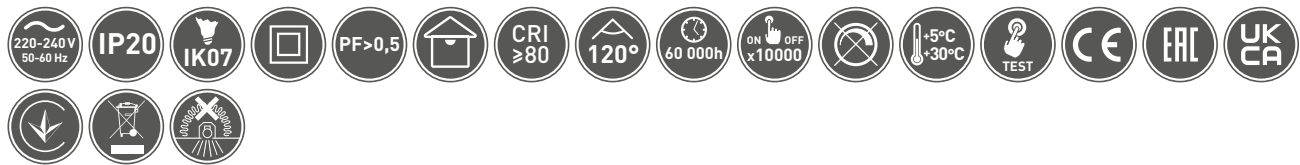

Technische  
und industrieleuchten

FR Luminaria de red y alumbrado de emergencia LED  
 ES Adaptador para farolas de calles y parques  
 DE LED-Nothinweisleuchte  
 HR LED panik svjetiljka

**OMAHA-3**

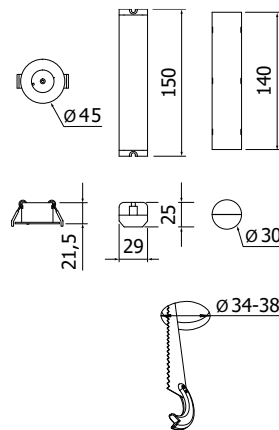

LD-OMAH33-00	3 W	3 h	6400 K	300 lm	aluminium + PC, aluminio + PC, Aluminium + PC, aluminij + PC	blanc, blanco, weiß, bijeli	350 g	5902801240522

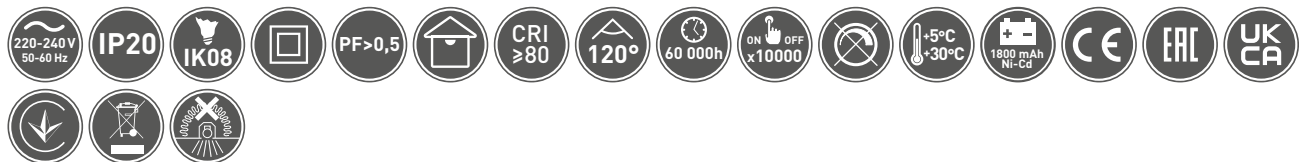





LUMINAIRES GRILLES  
LUMINARIAS CON REJILLA  
RASTERLEUCHTEN  
RASTER SVJETILJKE

FR Tube fluorescent  
ES Luminaria fluorescente  
DE Leuchtstoffleuchte  
HR LED tračna svjetiljka



Technische  
und industrieleuchten

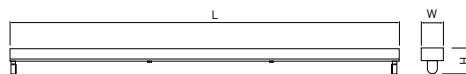
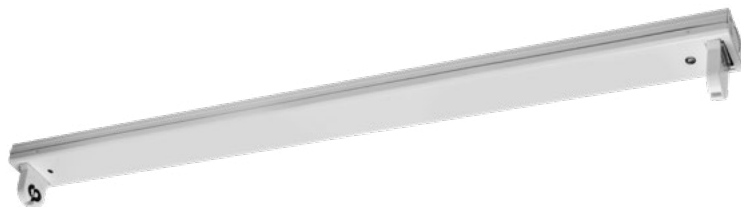

OS-OSL1120S-00	1230 × 42 × 47	Tôle d'acier, acero inoxidable, Stahlblech, čelični lim		320 g	5901867173737
OS-OSL1150S-00	1530 × 42 × 47			420 g	5901867173751



FR Tube fluorescent  
ES Luminaria fluorescente  
DE Leuchtstoffleuchte  
HR LED tračna svjetiljka



OS-OSL2120S-00	1230 × 100 × 47	Tôle d'acier, acero inoxidable, Stahlblech, čelični lim		380 g	5901867173744
OS-OSL2150S-00	1530 × 100 × 47			470 g	5901867173768



FR Luminaire à trame monté en applique  
 ES Luminaria rejilla de superficie  
 DE Aufbaurasterleuchte  
 HR LED nadgradni raster



Technische  
und industrielleuchten

Accessoires  
 Accesorios  
 Zubehör  
 Dodatna oprema:



OS-HERZWKPL4-00

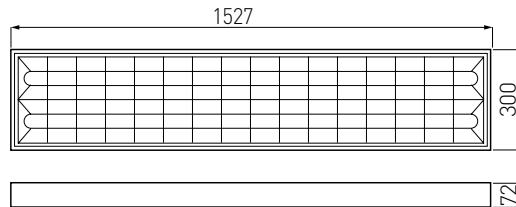

OS-LE150NJ-01



Tôle d'acier, acero inoxidable,  
Stahlblech, čelični lim



blanc, blanco,  
weiß, bijeli



3750 g



5908231307637











LUMINAIRES INDUSTRIELS  
LUMINARIAS INDUSTRIALES  
INDUSTRIELEUCHTEN  
INDUSTRIJSKE SVJETILJKE

FR Luminaire LED pour sources de lumière LED T8  
 ES Luminaria LED para fuentes de luz LED T8  
 DE LED-Leuchte für T8-Leuchtmittel  
 HR LED rasvjetno tijelo za izvore svjetla LED T8



**ZEFIR**

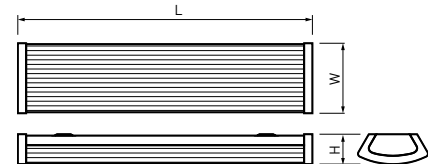

LD-OZE218-00	640 × 152 × 65	ABS + PC + Tôle d'acier, ABS + PC + acero inoxidable, ABS + PC + Stahlblech, ABS + PC + čelični lim	transparent, transparente, transparente	700 g	5901867159632
LD-OZE236-00	1250 × 152 × 65			1000 g	5901867151605



Technische und industrieleuchten

FR Luminaire LED pour sources de lumière LED T8  
 ES Luminaria LED para fuentes de luz LED T8  
 DE LED-Leuchte für T8-Leuchtmittel  
 HR LED rasvjetno tijelo za izvore svjetla LED T8



**ZEFIR**

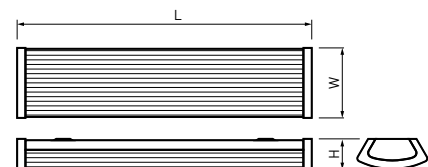

LD-OZE218-01	640 × 152 × 65	ABS + PC + Tôle d'acier, ABS + PC + acero inoxidable, ABS + PC + Stahlblech, ABS + PC + čelični lim	blanc doux, translucido, Schirm milchig, mliječni	700 g	5901867177582
LD-OZE236-01	1250 × 152 × 65			1000 g	5901867177698



FR Luminaire LED hermétique pour sources de lumière LED T8

ES Luminaria LED hermética para fuentes de luz LED T8

DE Hermetische LED-Leuchte für die Lichtquellen LED T8

HR LED vodotjesna svjetiljka za T8 cijevi



Technische  
und industrielleuchten

## HAGEN

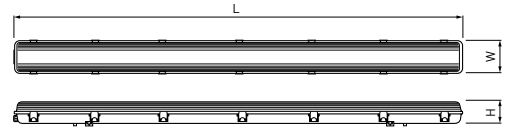

	LxWxH mm				
LD-HAG136-30	1288 x 72 x 68	PC / PC	blanc, blanco, weiß, bijeli	520 g	5901867194060
LD-HAG158-30	1598 x 72 x 68			900 g	5902801009877
LD-HAG218-30	684 x 114 x 68			1000 g	5901867194053
LD-HAG236-30	1288 x 114 x 68			900 g	5901867154606
LD-HAG258-30	1598 x 114 x 68			1000 g	5901867166395



FR Luminaire LED hermétique pour sources de lumière LED T8

ES Luminaria LED hermética para fuentes de luz LED T8

DE Hermetische LED-Leuchte für die Lichtquellen LED T8

HR LED vodotjesna svjetiljka za T8 cijevi



## HELIOS BIS

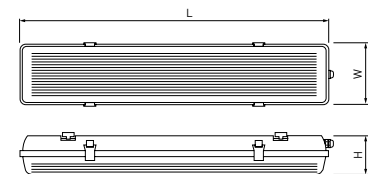



	LxWxH mm				
LD-HEL136B-30	1260 x 68 x 86	gris, gris, grau, sivi	ABS + PS	1500 g	5901867163325
LD-HEL218B-30	662 x 114 x 85			1500 g	5901867163301
LD-HEL236B-30	1260 x 114 x 86			1800 g	5901867163349
LD-HEL258B-30	1562 x 125 x 95			2500 g	5901867163363



- FR Pince métallique pour fixations HAGEN, côté  
 ES Abrazadera de metal para accesorios HAGEN, lateral  
 DE Metallklammer für HAGEN Leuchten, seitlich  
 HR Metalna kopča za svjetiljku HAGEN



	LD-HAG136-30	LD-HAG158-30	LD-HAG218-30	LD-HAG236-30	LD-HAG258-30	LD-HEL136B-30	LD-HEL218B-30	LD-HEL236B-30	LD-HEL258B-30
LD-HAG236KL-ME	12	14	8	12	14	-	-	-	-
LD-HEL236BU-ME	-	-	-	-	-	10	6	10	-
LD-HEL258BU-ME	-	-	-	-	-	-	-	-	12

		
LD-HAG236KL-ME	Metall, Metall, Metall, metalni	5901867189264
LD-HEL236BU-ME		5901867195548
LD-HEL258BU-ME		5902801026737

- FR Câble en acier  
 ES Cable de acero  
 DE Stahlleine zur Aufhängung  
 HR Čelični ovjes



				
OS-HERZW1-00	Metall, Metall, Metall, metalni	200 cm	19 g	5902801129551







PLAFONNIER LED  
PLAFONES Y LUMINARIAS PARA SÓTANOS  
DECKEN- UND FEUCHTRAUM-/AUSSENLEUCHTEN  
PLAFONJERE I BRODSKE SVJETILJKE

FR Plafonnier avec détecteur de mouvement  
 ES Plafón con detector de movimiento  
 DE Decken-/Wandleuchte mit Bewegungsmelder  
 HR Plafonjera sa senzorom pokreta

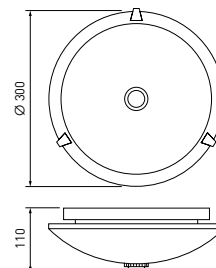

Technische  
und industrieleuchten



OS-PLCRKM-00	Metall + Verre, Metall + vidrio, Glas – Metall, metalni + staklo	blanc depoli, blanco mate, milchig, mliječni	1320 g	5908231302885
--------------	---	---	--------	---------------



FR Plafonnier avec détecteur de mouvement  
 ES Plafón con detector de movimiento  
 DE Decken-/Wandleuchte mit Bewegungsmelder  
 HR Plafonjera sa senzorom pokreta

## VIZELA

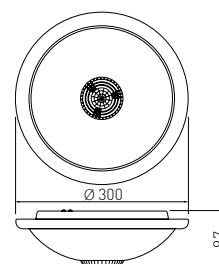

OS-PLCRKZ-00	Metall + Verre, Metall + vidrio, Glas – Metall, metalni + staklo	blanc, blanco, weiß, bijeli	860 g	5908231339973
--------------	---	-----------------------------	-------	---------------



FR Plafonnier avec détecteur de mouvement à micro-ondes  
 ES Plafón con detector de movimiento por microondas  
 DE Decken-/Wandleuchte mit Bewegungsmelder  
 HR Plafonjera s mikrovalnim senzorom pokreta

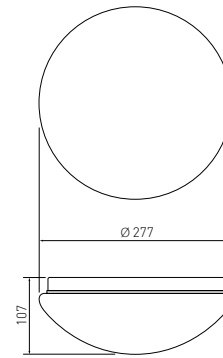

Technische  
und industrielleuchten



OS-PLCZMI-00	plastique, plástico, Kunststoff, plastika	blanc depoli, blanco mate, milchig, mliječni	500 g	5908231336996
--------------	---	--	-------	---------------



FR Plafonnier  
 ES Plafón  
 DE Deckenleuchte  
 HR Plafonjera

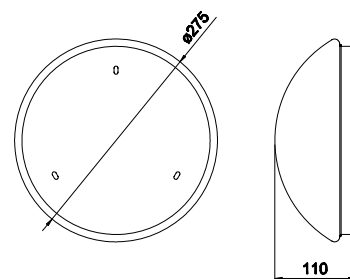

OS-PLCZOO-00	plastique, plástico, Kunststoff, plastika	blanc depoli, blanco mate, milchig, mliječni	300 g	5902801341601
--------------	---	--	-------	---------------



FR Plafonnier local technique  
 ES Luminaria para sótanos  
 DE Robuste Wand-/Deckenleuchte  
 HR Brodska svjetiljka

## IBIZA

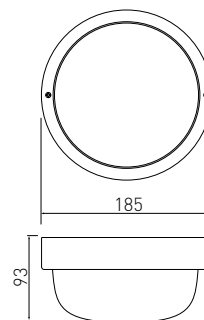

Technische  
und industrielleuchten

OS-IBBL060-00	corps: ABS, lentille: Verre, cuerpo: ABS, lente: vidrio, Gehäuse ABS; Schirm Glas, kućište ABS, leće: staklo,	blanc, blanco, weiß, bijeli	720 g	5908231338464



FR Plafonnier local technique  
 ES Luminaria para sótanos  
 DE Robuste Wand-/Deckenleuchte  
 HR Brodska svjetiljka

## IBIZA

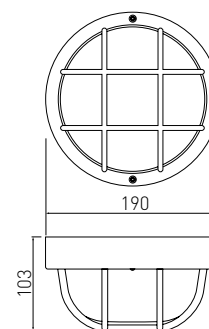

OS-IBKR060-00	corps: ABS, lentille: Verre, cuerpo: ABS, lente: vidrio, Gehäuse ABS; Schirm Glas, kućište ABS, leće: staklo,	blanc, blanco, weiß, bijeli	710 g	5908231338457





FR Plafonnier local technique  
 ES Luminaria para sótanos  
 DE Robuste Wand-/Deckenleuchte  
 HR Brodska svjetiljka



## RINGO

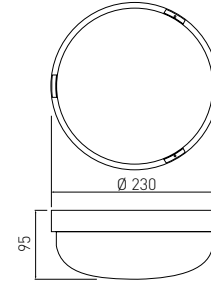

Technische  
und industrielleuchten



OS-RINGO1-00	corps: ABS, lentille: Verre, cuerpo: ABS, lente: vidrio, Gehäuse ABS; Schirm Glas, kućište ABS, leće: staklo,	blanc, blanco, weiß, bijeli	900 g	5901867122896
--------------	--	--------------------------------------	-------	---------------



FR Plafonnier avec détecteur de mouvement pour local technique  
 ES Luminaria para sótanos con detector de movimiento  
 DE Robuste Decken-/Wandleuchte mit Bewegungsmelder  
 HR Brodska svjetiljka sa senzorom pokreta



## KACROO

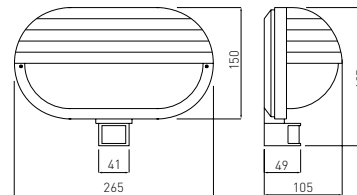

OS-KACROO-00	ABS + PC	blanc, blanco, weiß, bijeli	580 g	5908231302151
--------------	----------	-----------------------------	-------	---------------





FR Plafonnier local technique  
 ES Luminaria para sótanos  
 DE Robuste Wand-/Deckenleuchte  
 HR Brodska svjetiljka



## SANGUESA – KAY



White

Black

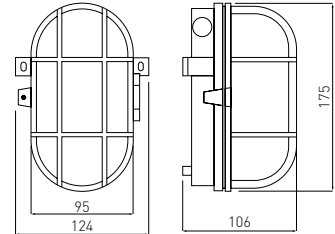

Technische  
und industrielleuchten



OS-KAY060-00		blanc, blanco, weiß, bijeli	560 g	5908231302137
OS-KAY060-10		noir, negro, schwarz, crna		5908231302144



FR Plafonnier local technique  
 ES Luminaria para sótanos  
 DE Robuste Wand-/Deckenleuchte  
 HR Brodska svjetiljka

## SANGUESA – KAM



White

Black

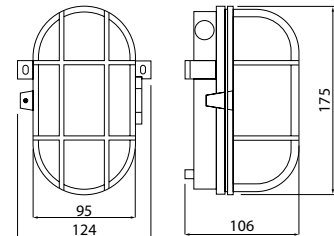

OS-KAM060-00	corps: ABS, lentille: Verre, cuerpo: ABS, lente: vidrio, Gehäuse: ABS; Schirm: Glas, kućište ABS, leće: staklo	blanc, blanco, weiß, bijeli	500 g	5908231394620
OS-KAM060-10		noir, negro, schwarz, crna		5908231337795











ECLAIRAGE D'ATELIER ET LAMPES TORCHES LED  
LUMINARIAS DE TALLER Y LINTERNAS LED  
WERKSTATTLEUCHTEN UND LED-TASCHENLAMPEN  
RADIONIČKE I RUČNE SVJETILJKE

FR Luminaire portable  
ES Luminaria portátil  
DE Tragbare Leuchte  
HR Prenosna radionička svjetiljka



OS-KAN527-24	60 W	Mettal + plastique, Metall + plástico, Metall + Kunststoff, metalni + plastika	550 g	5908231301307
--------------	------	--	-------	---------------



FR Luminaire portable  
ES Luminaria portátil  
DE Tragbare Leuchte  
HR Prenosna radionička svjetiljka



OS-KAG508-10		plastique, plástico, Kunststoff, plastika		5908231301284
--------------	--	---	--	---------------



FR Lampe Torche LED  
ES Linterna LED  
DE LED-Taschenlampe  
HR LED ručna svjetiljka

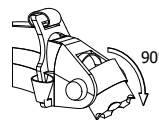
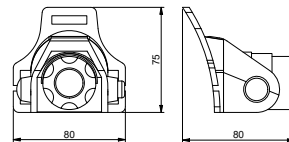

LT-LC6WT3-60	6 W	6400 K	350 lm	aluminium, aluminio, Aluminium, aluminij	175 g	5902801216336
--------------	-----	--------	--------	--	-------	---------------



FR Lampe Torche LED  
ES Linterna LED  
DE LED-Taschenlampe  
HR LED ručna svjetiljka

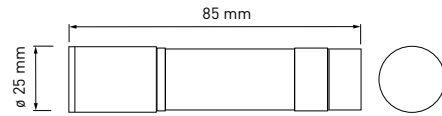

LT-LK3WBL-60

3 W

6400 K

150 lm

aluminium, aluminio,  
Aluminium, aluminij

35 g

5902801260063



Technische  
und industrieleuchten



FR Lampe Torche LED  
ES Linterna LED  
DE LED-Taschenlampe  
HR LED ručna svjetiljka

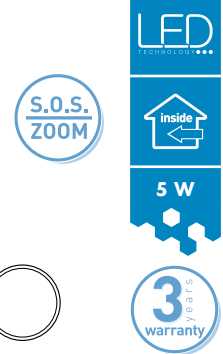
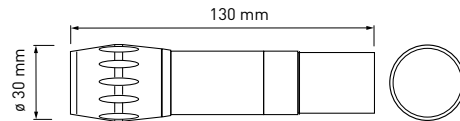

LT-LKSZ3W-60

5 W

6400 K

300 lm

aluminium, aluminio,  
Aluminium, aluminij

130 g

5902801260124



FR Lampe Torche LED  
ES Linterna LED  
DE LED-Taschenlampe  
HR LED ručna svjetiljka

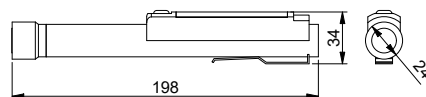

LT-LB6WT2-60

6 W

6400 K

400 lm

aluminium, aluminio,  
Aluminium, aluminij

140 g

5902801215858



FR Lampe Torche LED  
ES Linterna LED  
DE LED-Taschenlampe  
HR LED ručna svjetiljka

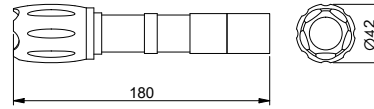
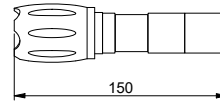

LED



8 W

3 years warranty



LT-LB8WT6-60

8 W

6400 K

800 lm

aluminium, aluminio,  
Aluminium, aluminij

135 g

5902801215278



FR Lampe Torche LED  
ES Linterna LED  
DE LED-Taschenlampe  
HR LED ručna svjetiljka

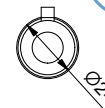
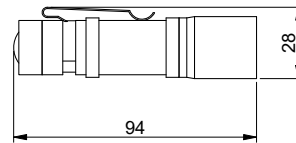

LED



3 W

3 years warranty



LT-LB3WT4-60

3 W

6400 K

200 lm

aluminium, aluminio,  
Aluminium, aluminij

40 g

5902801215797



FR Lampe Torche LED  
ES Linterna LED  
DE LED-Taschenlampe  
HR LED ručna svjetiljka

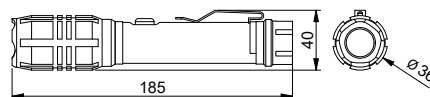

LED



8 W

3 years warranty



LT-LA8WT2-60

8 W

6400 K

800 lm

aluminium, aluminio,  
Aluminium, aluminij

220 g

5902801215865









ECLAIRAGE DÉCORATIF  
LUMINARIAS DECORATIVAS  
DEKORATIVE FASSUNGEN  
DEKORATIVNA RASVJETA



Plafonniers Luminarias de techo Deckenleuchten Stropne lampe .....	169
Spots Luminarias para la iluminación por puntos Punktstrahler Spot svjetiljke.....	220
Eclairage mural et jardin Luminarias para jardín y fachada Garten- und Fassadenleuchten Vanjska rasvjeta – vrtne i zidne svjetiljke .....	248
Lampes de bureau Lámparas de escritorio Schreibtischlampen Stolne svjetiljke .....	294



PLAFONNIERS  
LUMINARIAS DE TECHO  
DECKENLEUCHTEN  
STROPNE LAMPE



FR Luminaire linéaire LED  
ES Luminaria lineal LED  
DE Linienleuchte LED  
HR LED linearna svjetiljka

## OMEGA

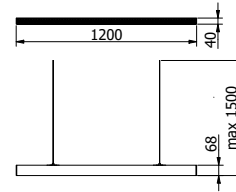
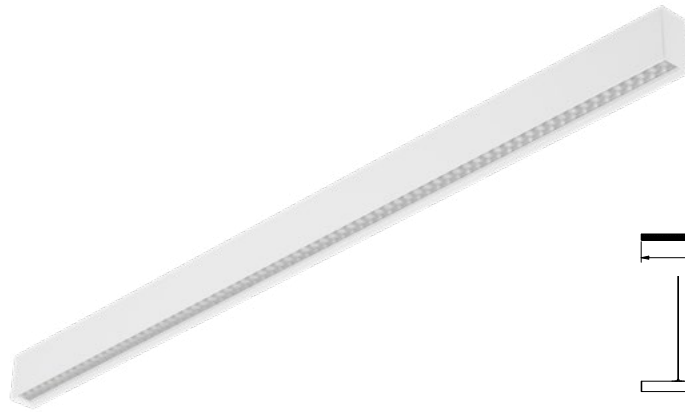

LD-OME50WNB-10-A*	50 W	max 15	● 4000 K	4500 lm	blanc, blanco, weiß, bijeli	aluminium + PC, aluminio + PC, Aluminium + PC, aluminij + PC,	1420 g	5902801245923
LD-OME50WNB-10-C								5902801245992

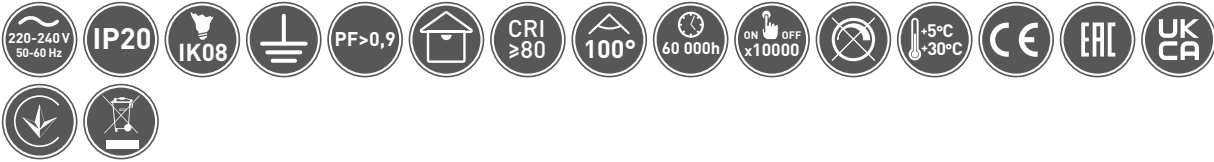

Dekorative fassungen



FR Accessoires  
ES Accesorios  
DE Zubehör  
HR Dodatna oprema

## OMEGA



LD-OME30WNB-10-L



LD-OME30WNB-10-T



LK-OMEGA-OP

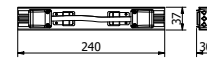
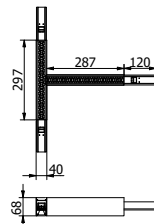
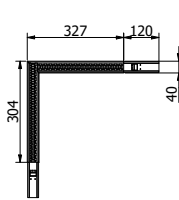

LD-OME30WNB-10-L	30 W	● 4000 K	2700 lm	blanc, blanco, weiß, bijeli	aluminium + PC, aluminio + PC, Aluminium + PC, aluminij + PC,	940 g	5902801245985
LD-OME30WNB-10-T						1060 g	5902801245831
LK-OMEGA-OP	-	-	-	-	Metall, Metall, Metall, metalni	100 g	5902801246012





FR Cadre LED suspendu  
ES Luminaria LED suspendida  
DE LED-Hängeleuchte  
HR LED ovjesna svjetiljka

LED  
LEDHOLOD...



40 W

5 years warranty

LUNA

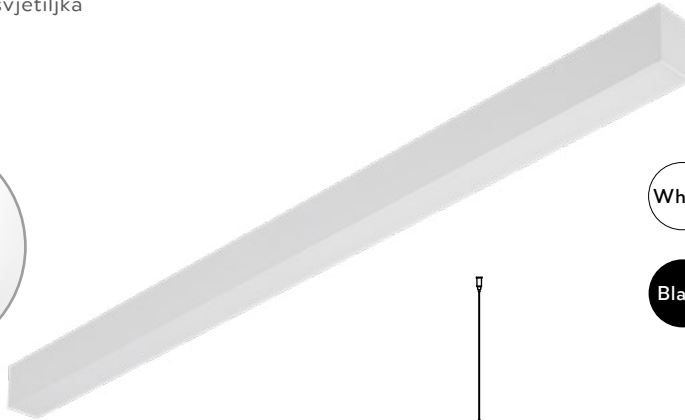
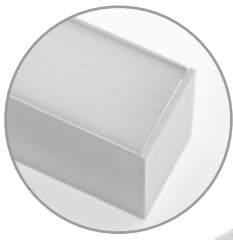

White

Black

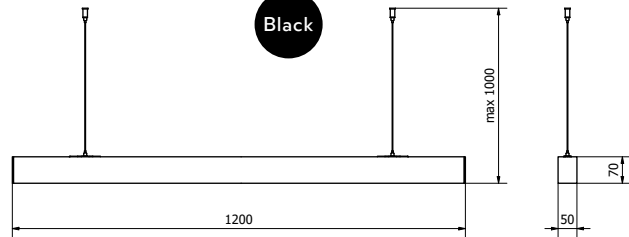

LD-LUN40WNB-10-A	40 W	4000 K	3200 lm	blanc, blanco, weiß, bijeli	aluminium + PC, aluminio + PC, Aluminium + PC, aluminij + PC,	1450 g	5902801245916
LD-LUN40WNB-00-A				noir, negro, schwarz, crna			5902801245961



Dekorative fassungen



FR Cadre pour montage encastré  
ES Marco para montaje empotrado  
DE Einlassmontagerahmen  
HR Okvir za ugrađenu montažu

LUNA



White

Black

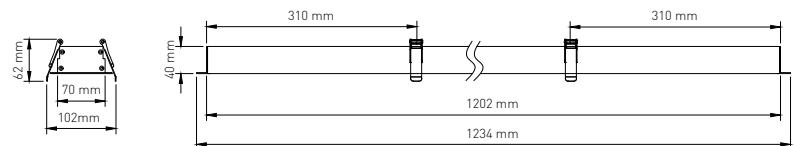

RM-LUNA120-10	-	-	-	blanc, blanco, weiß, bijeli	aluminium, aluminio, Aluminium, aluminij	850 g	5902801332258
RM-LUNA120-00	-	-	-	noir, negro, schwarz, crna			5902801332487

LED  
LEDHOLOD...



40 W

5 years warranty

FR Cadre LED suspendu  
ES Luminaria LED suspendida  
DE LED-Hängeleuchte  
HR LED ovjesna svjetiljka

## LIVIA

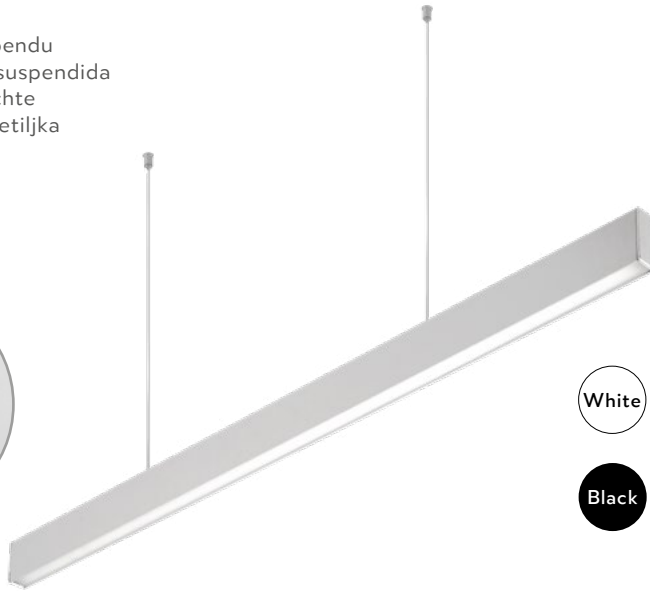
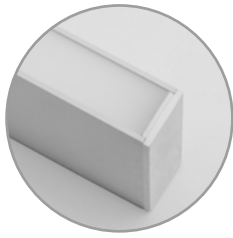

White

Black

Accessoires  
Accesorios  
Zubehör  
Dodatna oprema:

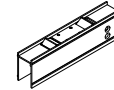

LK-LIVIA-OP

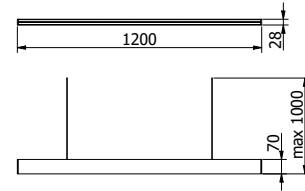

LED



40 W

5 years warranty



LD-LIV40WNB-10	40 W	4000 K	3600 lm	blanc, blanco, weiß, bijeli	aluminium, aluminio, Aluminium, aluminij	1300 g	5902801245893
LD-LIV40WNB-00				noir, negro, schwarz, crna			5902801243899
LK-LIVIA-OP	-	-	-	aluminium, aluminio, Aluminium, aluminij		70 g	5902801377143



FR Cadre LED suspendu  
ES Luminaria LED suspendida  
DE LED-Hängeleuchte  
HR LED ovjesna svjetiljka

## VILANA

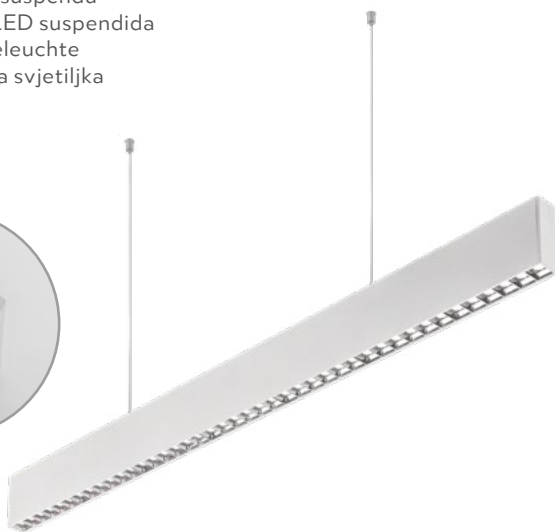

White

Black

Accessoires  
Accesorios  
Zubehör  
Dodatna oprema:

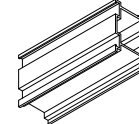

LK-VILANA-00

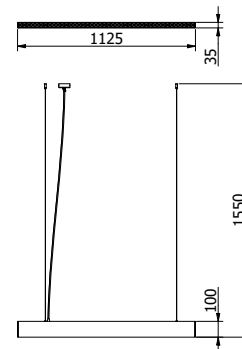

LED



42 W

UGR<19

12W / 30W

5 years warranty



LD-VIL42WUDB-NB	42 W	4000 K	3780 lm	blanc, blanco, weiß, bijeli	aluminium, aluminio, Aluminium, aluminij	2100 g	5902801237515
LD-VIL42WUDC-NB				noir, negro, schwarz, crna			5902801237546
LK-VILANA-00	-	-	-	aluminium, aluminio, Aluminium, aluminij		170 g	5902801285820





FR Cadre LED suspendu  
ES Luminaria LED suspendida  
DE LED-Hängeleuchte  
HR LED ovjesna svjetiljka

## FORTA

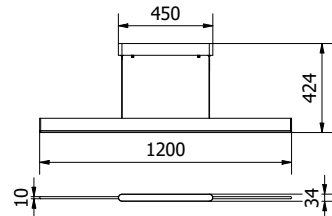

LED  
TECHNOLOGY

inside

36 W

5 years  
warranty

Dekorative fassungen



LD-FRT36WB-NB	36 W	● 4000 K	2900 lm	blanc, blanco, weiß, bijeli	aluminium, aluminio, Aluminium, aluminij	3300 g	5902801293313



FR Luminaire LED  
ES Luminaria LED  
DE LED-Leuchte  
HR LED ovjesna/nadgradna svjetiljka

## JASMIN

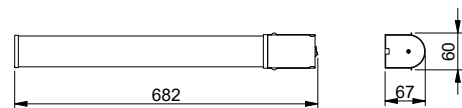

LED  
TECHNOLOGY

inside

15 W

5 years  
warranty

LD-JAS15W-40	15 W	● 4000 K	1200 lm	PC	blanc, blanco, weiß, bijeli	PF > 0,5	760 g	5902801200540



FR Luminaire LED  
ES Luminaria LED  
DE LED-Leuchte  
HR LED ovjesna/nadgradna svjetiljka

**ZITA**



White

Chrome

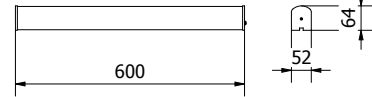

LD-ZIT600W-01	15 W	● 4000 K	1200 lm	aluminium + PC, aluminio + PC, Aluminium + PC, aluminij + PC,	chrome, cromado, Chrom, krom	4600 g	5902801399329
LD-ZIT600W-00				blanc, blanco, weiß, bijeli	5902801399466		

220-240 V 50-60 Hz	IP44	IK08	PF>0,5			CRI ≥80	120°	40 000h	ON/OFF x10000	+5°C +30°C			

Dekorative fassungen

FR Luminaire LED  
ES Luminaria LED  
DE LED-Leuchte  
HR LED ovjesna/nadgradna svjetiljka

**PRIME**

360°



White

Black

Grey

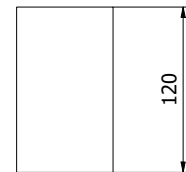
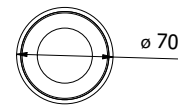

LD-PRM10WB-NB	10 W	● 4000 K	1000 lm	blanc, blanco, weiß, bijeli	aluminium, aluminio, Aluminium, aluminij	260 g	5902801293344
LD-PRM10WC-NB				noir, negro, schwarz, crna			5902801293238
LD-PRM10WS-NB				gris, gris, grau, sivi			5902801293481

220-240 V 50-60 Hz	IP20	IK08	PF>0,5			CRI ≥80	100°	60 000h	ON/OFF x10000	+5°C +30°C			

FR Luminaire LED  
ES Luminaria LED  
DE LED-Leuchte  
HR LED ovjesna/nadgradna svjetiljka

**BIANCO**



LED  
LEDNOLIGHT

inside

8 W

3 years warranty

Dekorative fassungen



LD-BNC8WKB-NB	8 W	● 4000 K	680 lm	blanc, blanco, weiß, bijeli	aluminium, aluminio, Aluminium, aluminij	320 g	5902801293412
LD-BNC8WKC-NB				noir, negro, schwarz, crna			5902801293368

FR Luminaire LED  
ES Luminaria LED  
DE LED-Leuchte  
HR LED ovjesna/nadgradna svjetiljka

**BIANCO**



LED  
LEDNOLIGHT

inside

8 W

3 years warranty

LD-BNC8WOB-NB	8 W	● 4000 K	680 lm	blanc, blanco, weiß, bijeli	aluminium, aluminio, Aluminium, aluminij	320 g	5902801293351
LD-BNC8WOC-NB				noir, negro, schwarz, crna			5902801293450







FR Luminaire LED  
ES Luminaria LED  
DE LED-Leuchte  
HR LED ovisna/nadgradna svjetiljka

## BIANCO CCT



White

Black

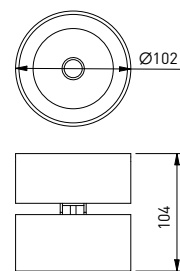

LD-BNCC8WOB-NB	8 W	<ul style="list-style-type: none"> <li>● 2700 K</li> <li>● 3300 K</li> <li>● 4000 K</li> </ul>	680 lm	blanc, blanco, weiß, bijeli	aluminium, aluminio, Aluminium, aluminij	320 g	5902801457043
LD-BNCC8WOC-NB				noir, negro, schwarz, crna			5902801457012



Dekorative fassungen



FR Luminaire LED  
ES Luminaria LED  
DE LED-Leuchte  
HR LED ovisna/nadgradna svjetiljka

## BIANCO CCT



White

Black

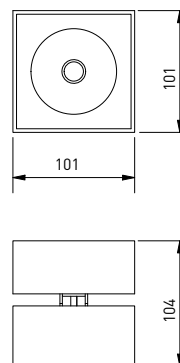

LD-BNCC8WKB-NB	8 W	<ul style="list-style-type: none"> <li>● 2700 K</li> <li>● 3300 K</li> <li>● 4000 K</li> </ul>	680 lm	blanc, blanco, weiß, bijeli	aluminium, aluminio, Aluminium, aluminij	320 g	5902801457036
LD-BNCC8WKC-NB				noir, negro, schwarz, crna			5902801457104



**BIANCO CCT**

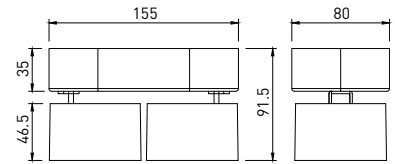

LD-BNCC16WOB2-NB	2 x 8 W	<ul style="list-style-type: none"> <li>● 2700 K</li> <li>● 3300 K</li> <li>● 4000 K</li> </ul>	1360 lm	blanc, blanco, weiß, bijeli	aluminium, aluminio, Aluminium, aluminij	700 g	5902801457142
LD-BNCC16WOC2-NB				noir, negro, schwarz, crna			5902801457029

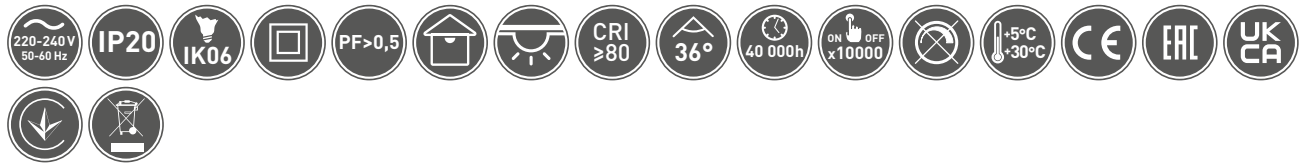

Dekorative fassungen



FR Luminaire LED  
ES Luminaria LED  
DE LED-Leuchte  
HR LED ovjesna/nadgradna svjetiljka

LED  
LEDNOLIGHTING

inside

15 W

3 years warranty

BIANCO



White

Black

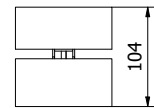
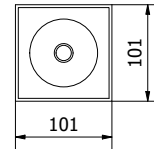

LD-BNC15WKB-NB	15 W	● 4000 K	1500 lm	blanc, blanco, weiß, bijeli	aluminium, aluminio, Aluminium, aluminij	680 g	5902801367090
LD-BNC15WKC-NB				noir, negro, schwarz, crna			5902801367144

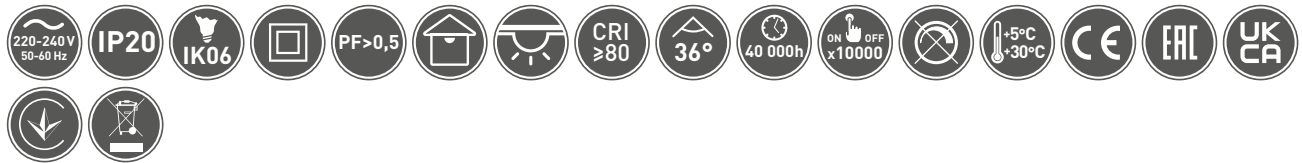

Dekorative fassungen



FR Luminaire LED  
ES Luminaria LED  
DE LED-Leuchte  
HR LED ovjesna/nadgradna svjetiljka

LED  
LEDNOLIGHTING

inside

15 W

3 years warranty

BIANCO



White

Black

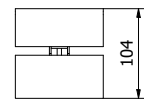
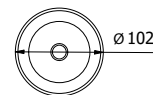

LD-BNC15WOB-NB	15 W	● 4000 K	1500 lm	blanc, blanco, weiß, bijeli	aluminium, aluminio, Aluminium, aluminij	600 g	5902801367182
LD-BNC15WOC-NB				noir, negro, schwarz, crna			5902801367151

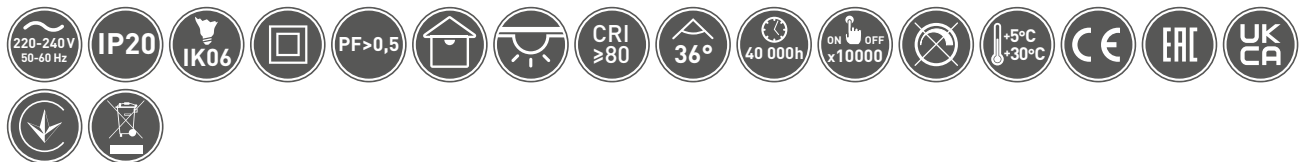







FR Luminaire LED  
ES Luminaria LED  
DE LED-Leuchte  
HR LED ovisna/nadgradna svjetiljka

## SIERRA

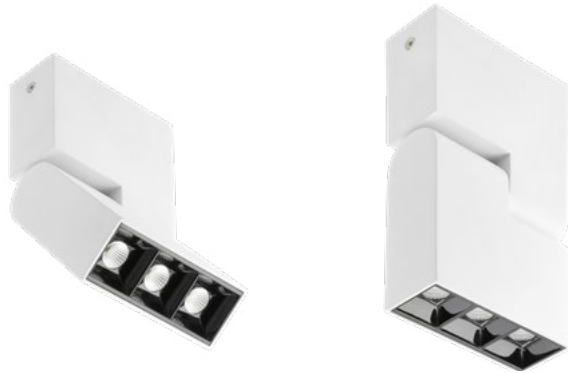

White

Black

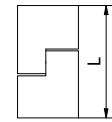
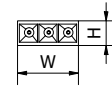

LED  
LEDNOLIGHT



8 W

3 years  
warranty



LxWxH  
mm



LD-SRA08WB-NB	8 W	● 4000 K	720 lm	blanc, blanco, weiß, bijeli	aluminium, aluminio, Aluminium, aluminij	155 x 84 x 34	410 g	5902801357268
LD-SRA08WC-NB				noir, negro, schwarz, crna				5902801357459

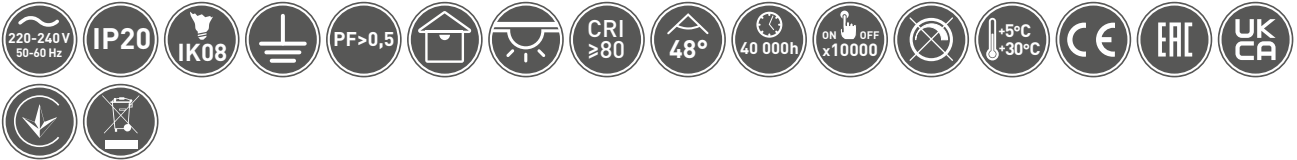

FR Luminaire LED  
ES Luminaria LED  
DE LED-Leuchte  
HR LED ovisna/nadgradna svjetiljka

## SIERRA

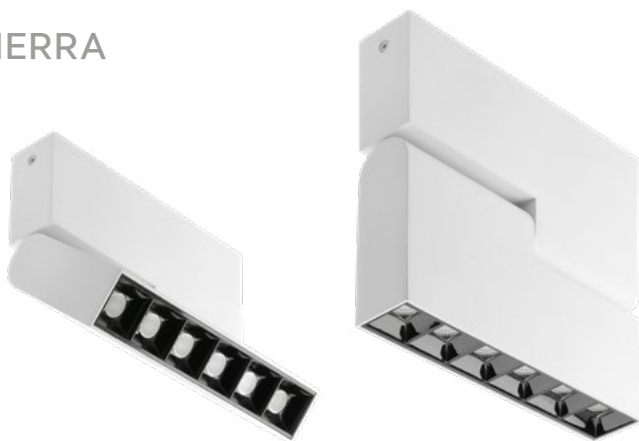

White

Black

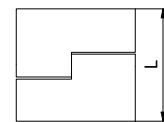
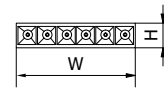

LED  
LEDNOLIGHT



18 W

3 years  
warranty



LxWxH  
mm



LD-SRA18WB-NB	18 W	● 4000 K	1620 lm	blanc, blanco, weiß, bijeli	aluminium, aluminio, Aluminium, aluminij	158 x 163 x 34	770 g	5902801357466
LD-SRA18WC-NB				noir, negro, schwarz, crna				5902801357497

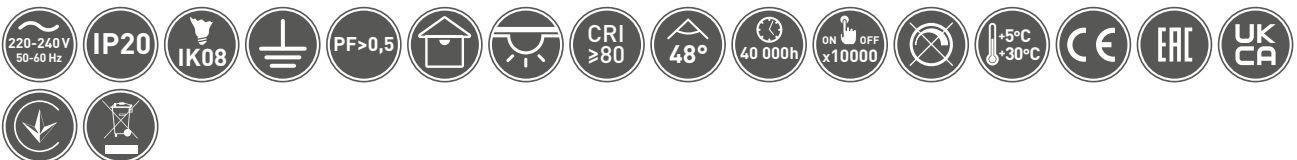



FR Luminaire LED  
ES Luminaria LED  
DE LED-Leuchte  
HR LED ovjesna/nadgradna svjetiljka

## ARTEMIDA



White

Black

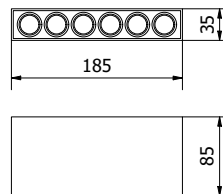

LED  
LEDNOLIGHT

inside

15 W

3 years  
warranty

Dekorative fassungen



LD-ATM15WBP-NB	15 W	● 4000 K	1420 lm	blanc, blanco, weiß, bijeli	aluminium, aluminio, Aluminium, aluminij	270 g	5902801322365
LD-ATM15WCP-NB				noir, negro, schwarz, crna			5902801322341



FR Luminaire LED  
ES Luminaria LED  
DE LED-Leuchte  
HR LED ovjesna/nadgradna svjetiljka

## ARTEMIDA

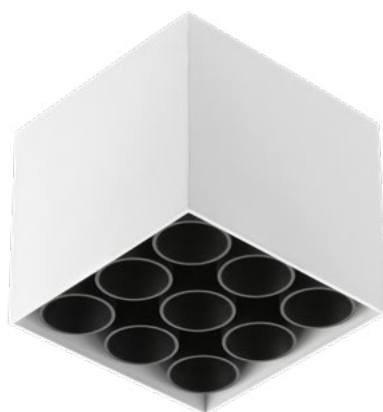
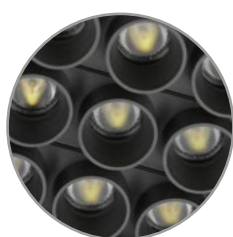

White

Black

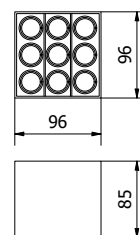

LED  
LEDNOLIGHT

inside

20 W

3 years  
warranty

LD-ATM20WBK-NB	20 W	● 4000 K	1920 lm	blanc, blanco, weiß, bijeli	aluminium, aluminio, Aluminium, aluminij	520 g	5902801322334
LD-ATM20WCK-NB				noir, negro, schwarz, crna			5902801322457









FR Plafonnier  
ES Luminaria de techo  
DE Deckenleuchte  
HR Nadgradna svjetiljka

## TENSA

360°



White

Black

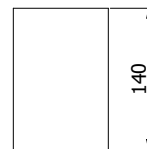
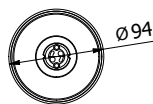

GU10



3 years warranty



OS-TENGU10-10	max 20 W	blanc, blanco, weiß, bijeli	aluminium, aluminio, Aluminium, aluminij	425 g	5902801274633
OS-TENGU10-00		noir, negro, schwarz, crna			5902801274596



FR Plafonnier  
ES Luminaria de techo  
DE Deckenleuchte  
HR Nadgradna svjetiljka

## TENSA

360°



White

Black

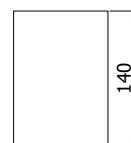
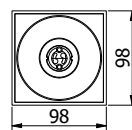

GU10



3 years warranty

OS-TENGU10KW-10	max 20 W	blanc, blanco, weiß, bijeli	aluminium, aluminio, Aluminium, aluminij	475 g	5902801274664
OS-TENGU10KW-00		noir, negro, schwarz, crna			5902801274763





FR Plafonnier  
ES Luminaria de techo  
DE Deckenleuchte  
HR Nadgradna svjetiljka

**AERO II**

360°



White

Black

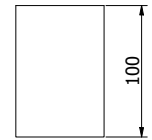
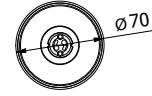

Dekorative fassungen



OS-AERD20W-10	max 20 W	blanc, blanco, weiß, bijeli	aluminium, aluminio, Aluminium, aluminij	210 g	5902801396250
OS-AERD20W-00		noir, negro, schwarz, crna			5902801396939



FR Cadre LED suspendu  
ES Luminaria LED suspendida  
DE LED-Hängeleuchte  
HR LED ovjesna svjetiljka

## LAGOS II



White

Black

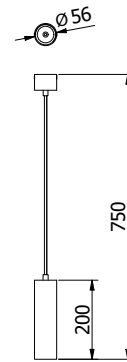

OS-LAGD20W-10	max 20 W	blanc, blanco, weiß, bijeli	aluminium, aluminio, Aluminium, aluminij	400 g	5902801396892
OS-LAGD20W-00		noir, negro, schwarz, crna			5902801396960



FR Cadre LED suspendu  
ES Luminaria LED suspendida  
DE LED-Hängeleuchte  
HR LED ovjesna svjetiljka

## TRESOS II



White

Black

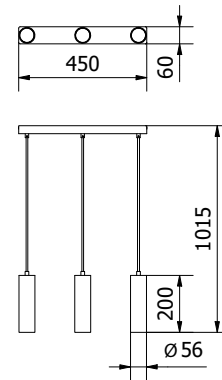

OS-TRESD320W-10	max 3x20 W	blanc, blanco, weiß, bijeli	aluminium, aluminio, Aluminium, aluminij	1400 g	5902801397004
OS-TRESD320W-00		noir, negro, schwarz, crna			5902801396946





FR Plafonnier  
ES Luminaria de techo  
DE Deckenleuchte  
HR Nadgradna svjetiljka

**AVEIRO BIS**

360°



White

Black

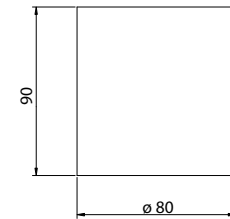
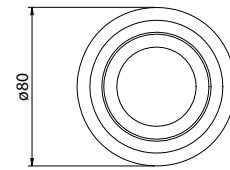

OS-AVB8090OK1-10	max 20 W	blanc, blanco, weiß, bijeli	aluminium, aluminio, Aluminium, aluminij	216 g	5902801396731
OS-AVB8090OK1-00		noir, negro, schwarz, crna			5902801396779



Dekorative fassungen



FR Plafonnier  
ES Luminaria de techo  
DE Deckenleuchte  
HR Nadgradna svjetiljka

**AVEIRO BIS**

360°



White

Black

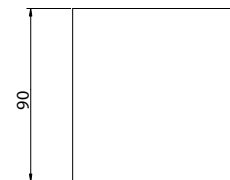
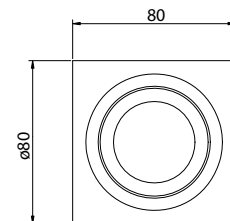

OS-AVB8090KW1-10	max 20 W	blanc, blanco, weiß, bijeli	aluminium, aluminio, Aluminium, aluminij	320 g	5902801396748
OS-AVB8090KW1-00		noir, negro, schwarz, crna			5902801396823





FR Plafonnier  
ES Luminaria de techo  
DE Deckenleuchte  
HR Nadgradna svjetiljka

**AVEIRO DUO BIS**

360°



White

Black

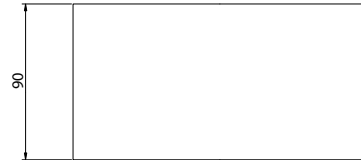
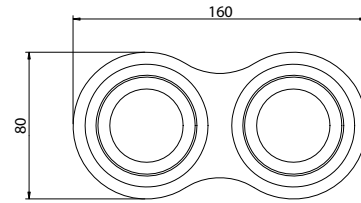

OS-AVB80160OK2-10	max 2 x 20 W	blanc, blanco, weiß, bijeli	aluminium, aluminio, Aluminium, aluminij	510 g	5902801396717
OS-AVB80160OK2-00		noir, negro, schwarz, crna			5902801396816



Dekorative fassungen



FR Plafonnier  
ES Luminaria de techo  
DE Deckenleuchte  
HR Nadgradna svjetiljka

**AVEIRO DUO BIS**

360°



White

Black

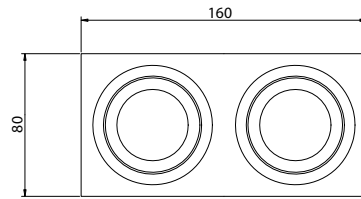

OS-AVB80160KW2-10	max 2 x 20 W	blanc, blanco, weiß, bijeli	aluminium, aluminio, Aluminium, aluminij	525 g	5902801396885
OS-AVB80160KW2-00		noir, negro, schwarz, crna			5902801396908









FR Plafonnier  
ES Luminaria de techo  
DE Deckenleuchte  
HR Nadgradna svjetiljka

## SENSA MINI



Black

White

Accessoires  
Accesorios  
Zubehör  
Dodatna oprema:

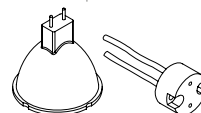

MR16 GZ-MR16-0000

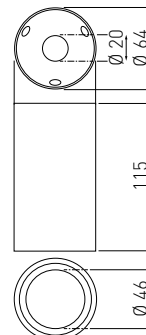

3  
years  
warranty



OS-SENM5081OKCZ-00	max 50 W	noir, negro, schwarz, crna	aluminium, aluminio, Aluminium, aluminij	5901867176769
OS-SENM5081OKB-10		blanc, blanco, weiß, bijeli		5901867176752



FR Plafonnier  
ES Luminaria de techo  
DE Deckenleuchte  
HR Nadgradna svjetiljka

## SENSA MINI



White

Black

Accessoires  
Accesorios  
Zubehör  
Dodatna oprema:

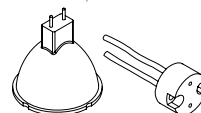

MR16 GZ-MR16-0000

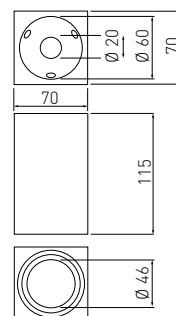

3  
years  
warranty



OS-SENM5091KWB-10	max 50 W	blanc, blanco, weiß, bijeli	aluminium, aluminio, Aluminium, aluminij	5901867176837
OS-SENM5091KW CZ-00		noir, negro, schwarz, crna		5901867176851





FR Plafonnier  
ES Luminaria de techo  
DE Deckenleuchte  
HR Nadgradna svjetiljka

**SENSA**



Black

White

Accessoires  
Accesorios  
Zubehör  
Dodatna oprema:

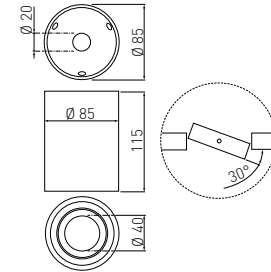
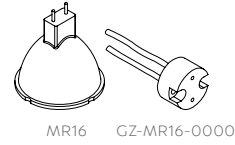

Dekorative fassungen



OS-SEN5087OKCZ-00	max 50 W	noir, negro, schwarz, crna	aluminium, aluminio, Aluminium, aluminij	5901867176813
OS-SEN5087OKB-10		blanc, blanco, weiß, bijeli		5901867176776



FR Plafonnier  
ES Luminaria de techo  
DE Deckenleuchte  
HR Nadgradna svjetiljka

**SENSA**

360°

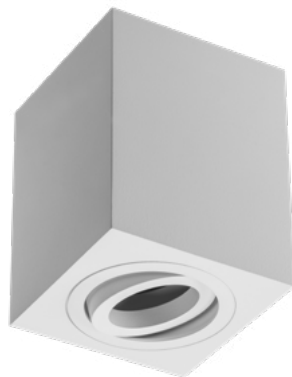

White

Black

Accessoires  
Accesorios  
Zubehör  
Dodatna oprema:

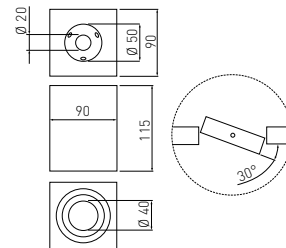
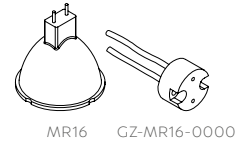

OS-SEN5097KWB-10	max 50 W	blanc, blanco, weiß, bijeli	aluminium, aluminio, Aluminium, aluminij	5901867176875
OS-SEN5097KW CZ-00		noir, negro, schwarz, crna		5901867176899



FR Plafonnier  
ES Luminaria de techo  
DE Deckenleuchte  
HR Nadgradna svjetiljka

## SENSA AQUA



White

Grey

Black

Accessoires  
Accesorios  
Zubehör  
Dodatna oprema:

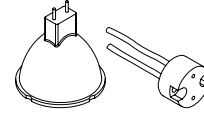

MR16 GZ-MR16-0000

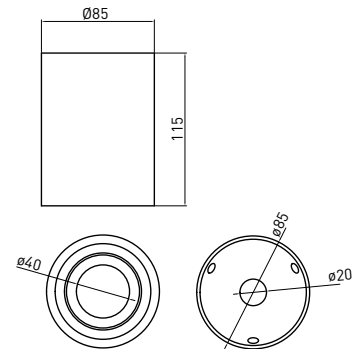

3 years warranty



OS-SENAQ5087OKB-10	max 50 W	blanc, blanco, weiß, bijeli	aluminium, aluminio, Aluminium, aluminij	300 g	5902801233791
OS-SENAQ5087OKB-80		gris, gris, grau, sivi			5902801233821
OS-SENAQ5087OKCZ-00		noir, negro, schwarz, crna			5902801233838



FR Plafonnier  
ES Luminaria de techo  
DE Deckenleuchte  
HR Nadgradna svjetiljka

## SENSO DUO



White

Black

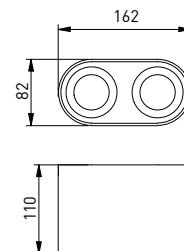

GU10

3 years warranty



OS-SEND5083OKB-10	max 2 x 50 W	blanc, blanco, weiß, bijeli	aluminium, aluminio, Aluminium, aluminij	720 g	5902801129971
OS-SEND5083OKCZ-00		noir, negro, schwarz, crna			5902801129933







FR Plafonnier  
ES Luminaria de techo  
DE Deckenleuchte  
HR Nadgradna svjetiljka

Accessoires  
Accesorios  
Zubehör  
Dodatna oprema:

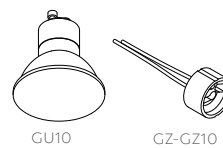

GU10

GZ-GZ10

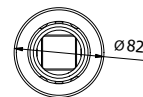

Ø82

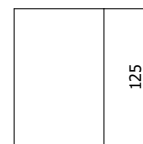

125

## RESTO



White

Black



OS-RST80125OK1-10	max 10 W LED only	blanc, blanco, weiß, bijeli	PC	110 g	5902801319556
OS-RST80125OK1-00		noir, negro, schwarz, crna			5902801319457



Dekorative fassungen



FR Plafonnier  
ES Luminaria de techo  
DE Deckenleuchte  
HR Nadgradna svjetiljka

Accessoires  
Accesorios  
Zubehör  
Dodatna oprema:

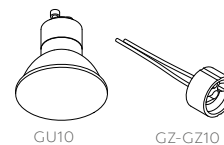

GU10

GZ-GZ10

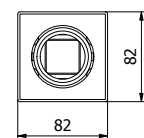

82

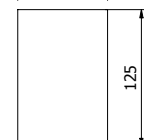

125

## RESTO



White

Black



OS-RST8080KW1-10	max 10 W LED only	blanc, blanco, weiß, bijeli	PC	130 g	5902801319570
OS-RST8080KW1-00		noir, negro, schwarz, crna			5902801319433





FR Plafonnier  
ES Luminaria de techo  
DE Deckenleuchte  
HR Nadgradna svjetiljka

Accessoires  
Accesorios  
Zubehör  
Dodatna oprema:

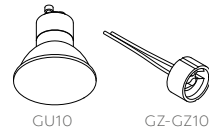

**ARIES**



OS-ARIOK-11



OS-ARIOK-13



OS-ARIOK-22



OS-ARIOK-23

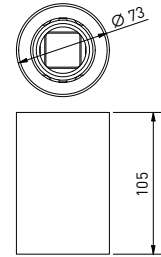

OS-ARIOK-11	max 20 W	noir, negro, schwarz, crna	PC	80 g	5902801440113
OS-ARIOK-22		chrome noir, negro cromado, Schwarzchrom, crni krom			5902801442841
OS-ARIOK-23		chrome, cromado, Chrom, krom			5902801442889
OS-ARIOK-13		or ancient, oro antiguo, Altgold, staro zlato			5902801442803



Dekorative fassungen



FR Plafonnier  
ES Luminaria de techo  
DE Deckenleuchte  
HR Nadgradna svjetiljka

Accessoires  
Accesorios  
Zubehör  
Dodatna oprema:

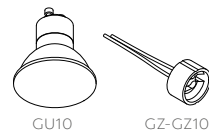

**ARIES**



OS-ARIKW-11



OS-ARIKW-13



OS-ARIKW-22



OS-ARIKW-23

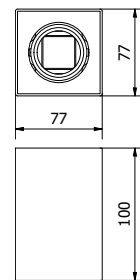

OS-ARIKW-11	max 20 W	noir, negro, schwarz, crna	PC	90 g	5902801443114
OS-ARIKW-22		chrome noir, negro cromado, Schwarzchrom, crni krom			5902801442933
OS-ARIKW-23		chrome, cromado, Chrom, krom			5902801402470
OS-ARIKW-13		or ancient, oro antiguo, Altgold, staro zlato			5902801402630



# DRAGO

360°



White

Black

Grey

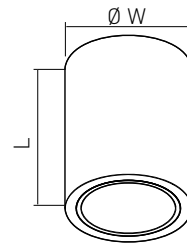

Folder	W	Roof	Box	LxW mm	Weight	Barcode
OS-DRAGO14-10	max 60 W	blanc, blanco, weiß, bijeli	Metall, Metall, Metall, metalni	148 x ø133	390 g	5902801230394
OS-DRAGO18-10				180 x ø172	700 g	5902801230400
OS-DRAGO14-00		noir, negro, schwarz, crna		148 x ø133	390 g	5902801231131
OS-DRAGO18-00				180 x ø172	700 g	5902801231063
OS-DRAGO14-80		gris, gris, grau, sivi		148 x ø133	390 g	5902801364341
OS-DRAGO18-80				180 x ø172	700 g	5902801364983



Dekorative fassungen





FR Plafonnier  
ES Luminaria de techo  
DE Deckenleuchte  
HR Nadgradna svjetiljka

## BLINK II



White

Black



OS-BLND50W1-10	max. 20 W	blanc, blanco, weiß, bijeli	aluminium, aluminio, Aluminium, aluminij	267 g	5902801438813
OS-BLND50W1-00		noir, negro, schwarz, crna			5902801439735

Dekorative fassungen



FR Plafonnier  
ES Luminaria de techo  
DE Deckenleuchte  
HR Nadgradna svjetiljka

## BLINK II

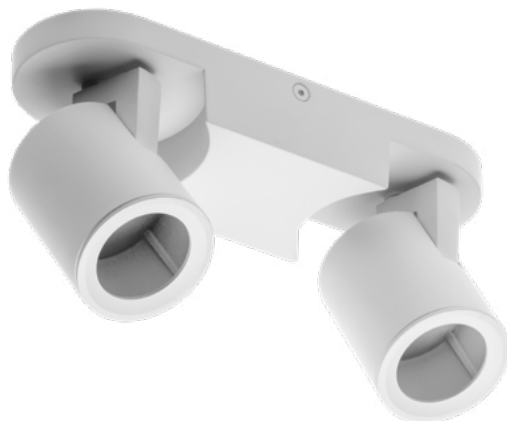

White

Black



OS-BLND50W2-10	max. 2 x 20 W	blanc, blanco, weiß, bijeli	aluminium, aluminio, Aluminium, aluminij	560 g	5902801438301
OS-BLND50W2-00		noir, negro, schwarz, crna			5902801440069



FR Plafonnier  
ES Luminaria de techo  
DE Deckenleuchte  
HR Nadgradna svjetiljka

## BLINK II

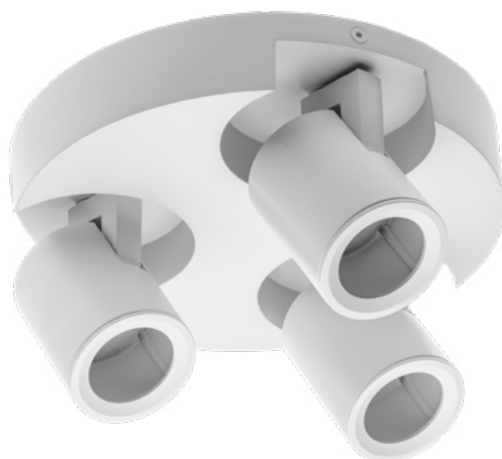

White

Black



OS-BLND50W3-10	max. 3 x 20 W	blanc, blanco, weiß, bijeli	aluminium, aluminio, Aluminium, aluminij	850 g	5902801438271
OS-BLND50W3-00		noir, negro, schwarz, crna			5902801440120



FR Plafonnier  
ES Luminaria de techo  
DE Deckenleuchte  
HR Nadgradna svjetiljka

## FARGO II



White

Black

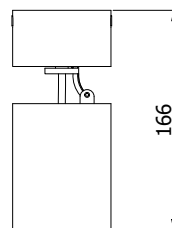
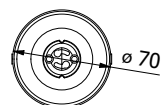

OS-FRG20W2-10	max 20 W	blanc, blanco, weiß, bijeli	aluminium, aluminio, Aluminium, aluminij	280 g	5902801391255
OS-FRG20W2-00		noir, negro, schwarz, crna			5902801391286



FR Plafonnier  
ES Luminaria de techo  
DE Deckenleuchte  
HR Nadgradna svjetiljka

## FARGO MINI II



White

Black

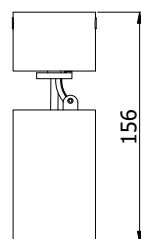
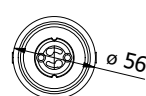

OS-FRG20W2-10-MINI	max 20 W	blanc, blanco, weiß, bijeli	aluminium, aluminio, Aluminium, aluminij	220 g	5902801333804
OS-FRG20W2-00-MINI		noir, negro, schwarz, crna			5902801333811



FR Plafonnier  
ES Luminaria de techo  
DE Deckenleuchte  
HR Nadgradna svjetiljka

**SANTO BIS**



White

Black

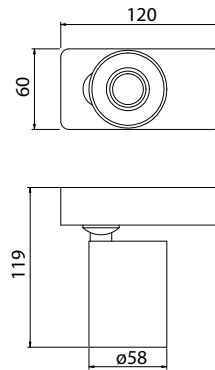

OS-SAN20WOK1B-10	max 20 W	blanc, blanco, weiß, bijeli	aluminium, aluminio, Aluminium, aluminij	310 g	5902801336300
OS-SAN20WOK1B-00		noir, negro, schwarz, crna			5902801336355



Dekorative fassungen

FR Plafonnier  
ES Luminaria de techo  
DE Deckenleuchte  
HR Nadgradna svjetiljka

**SANTO BIS**



White

Black

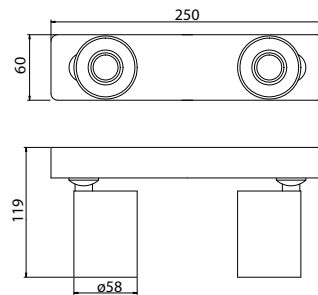

OS-SAN20WOK2B-10	max 2 x 20 W	blanc, blanco, weiß, bijeli	aluminium, aluminio, Aluminium, aluminij	590 g	5902801336218
OS-SAN20WOK2B-00		noir, negro, schwarz, crna			5902801336393





FR Applique murale  
ES Luminaria de pared  
DE Wandleuchte  
HR Nadgradna spot svjetiljka

## RENO

360°



White

Black

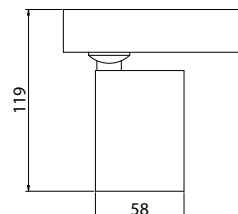
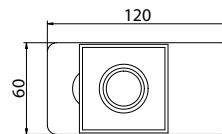

OS-REN20WKW1-10	max 20 W	blanc, blanco, weiß, bijeli	aluminium, aluminio, Aluminium, aluminij	460 g	5902801244599
OS-REN20WKW1-00		noir, negro, schwarz, crna			5902801243974



FR Plafonnier  
ES Luminaria de techo  
DE Deckenleuchte  
HR Nadgradna svjetiljka

## RENO

360°



White

Black

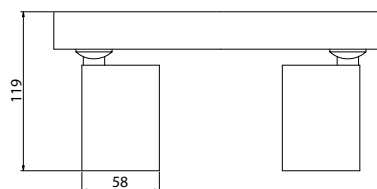
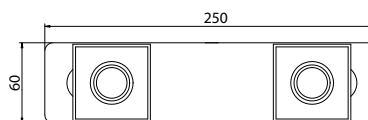

OS-REN20WKW2-10	max 2 x 20 W	blanc, blanco, weiß, bijeli	aluminium, aluminio, Aluminium, aluminij	860 g	5902801244575
OS-REN20WKW2-00		noir, negro, schwarz, crna			5902801244636



FR Plafonnier  
ES Luminaria de techo  
DE Deckenleuchte  
HR Nadgradna svjetiljka

## VENETO



White

Black

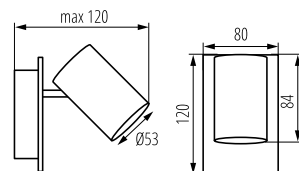

OS-VEN20WO1-00	max 20 W	blanc, blanco, weiß, bijeli	aluminium, aluminio, Aluminium, aluminij	256 g	5902801442988
OS-VEN20WO1-10		noir, negro, schwarz, crna			5902801443237



FR Plafonnier  
ES Luminaria de techo  
DE Deckenleuchte  
HR Nadgradna svjetiljka

## VENETO



White

Black

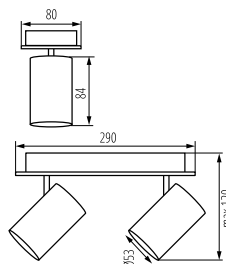

OS-VEN20WO2-00	max 2 X 20 W	blanc, blanco, weiß, bijeli	aluminium, aluminio, Aluminium, aluminij	546 g	5902801402357
OS-VEN20WO2-10		noir, negro, schwarz, crna			5902801443404



Dekorative fassungen

FR Plafonnier  
ES Luminaria de techo  
DE Deckenleuchte  
HR Nadgradna svjetiljka

**VENETO**

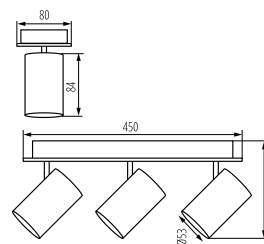

White

Black



OS-VEN20WO3-00	max 3 x 20 W	blanc, blanco, weiß, bijeli	aluminium, aluminio, Aluminium, aluminij	815 g	5902801443350
OS-VEN20WO3-10		noir, negro, schwarz, crna			5902801443381



Dekorative fassungen



FR Plafonnier  
ES Luminaria de techo  
DE Deckenleuchte  
HR Nadgradna svjetiljka

**VENETO**

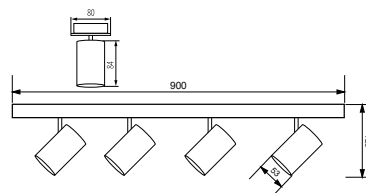

White

Black



OS-VEN20WO4-00	max 4 x 20 W	blanc, blanco, weiß, bijeli	aluminium, aluminio, Aluminium, aluminij	1216 g	5902801442896
OS-VEN20WO4-10		noir, negro, schwarz, crna			5902801402364



FR Plafonnier  
ES Luminaria de techo  
DE Deckenleuchte  
HR Nadgradna svjetiljka

**VENETO**

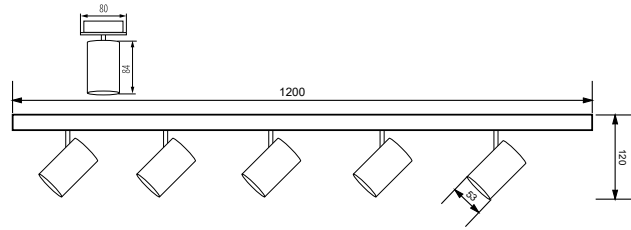

White

Black



OS-VEN20WO5-00	max 5 x 20 W	noir, negro, schwarz, crna	aluminium, aluminio, Aluminium, aluminij	1592 g	5902801441783
OS-VEN20WO5-10		blanc, blanco, weiß, bijeli			5902801402562



Dekorative fassungen



FR Plafonnier  
ES Luminaria de techo  
DE Deckenleuchte  
HR Nadgradna svjetiljka

**VENETO**



White

Black

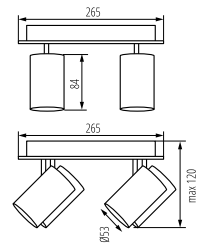

OS-VEN20WOK4-00	max 4 x 20 W	noir, negro, schwarz, crna	aluminium, aluminio, Aluminium, aluminij	1268 g	5902801401749
OS-VEN20WOK4-10		blanc, blanco, weiß, bijeli			5902801441660





FR Plafonnier  
ES Luminaria de techo  
DE Deckenleuchte  
HR Stropno rasvjetno tijelo

**ORIO**

**NEW**



White

Black

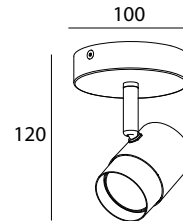

Dekorative fassungen



Code	Power	Color	Material	Weight	Barcode
OS-ORI-GU10-00	max. 20 W	blanc, blanco, weiß, bijeli	aluminium, aluminio, Aluminium, aluminij	350 g	5902801391224
OS-ORI-GU10-10		noir, negro, schwarz, crna		350 g	5902801391019



FR Plafonnier  
ES Luminaria de techo  
DE Deckenleuchte  
HR Stropno rasvjetno tijelo

**ORIO**

**NEW**



White

Black

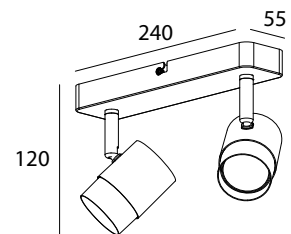

Code	Power	Color	Material	Weight	Barcode
OS-ORI-2GU10-00	max. 2 x 20 W	blanc, blanco, weiß, bijeli	aluminium, aluminio, Aluminium, aluminij	520 g	5902801391170
OS-ORI-2GU10-10		noir, negro, schwarz, crna		520 g	5902801391064



FR Plafonnier  
 ES Luminaria de techo  
 DE Deckenleuchte  
 HR Stropno rasvjetno tijelo

**ORIO**



White

Black

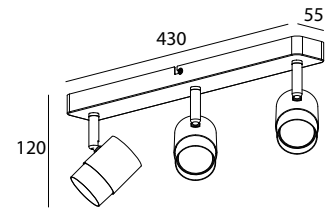

Folder	Wattage	Color	Material	Weight	Barcode
OS-ORI-3GU10-00	max. 3 x 20 W	blanc, blanco, weiß, bijeli	aluminium, aluminio, Aluminium, aluminij	820 g	5902801391187
OS-ORI-3GU10-10		noir, negro, schwarz, crna		820 g	5902801391163



Dekorative fassungen



FR Plafonnier  
ES Luminaria de techo  
DE Deckenleuchte  
HR Stropno rasvjetno tijelo

## LUPO



White

Black

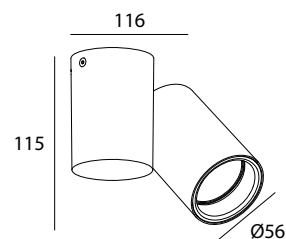

Dekorative fassungen



Folder	Wattage	Color	Material	Weight	Barcode
OS-LUP-GU10-00	max. 20 W	blanc, blanco, weiß, bijeli	aluminium, aluminio, Aluminium, aluminij	310 g	5902801391279
OS-LUP-GU10-10		noir, negro, schwarz, crna		310 g	5902801391309



FR Plafonnier  
ES Luminaria de techo  
DE Deckenleuchte  
HR Stropno rasvjetno tijelo

## LUPO



White

Black

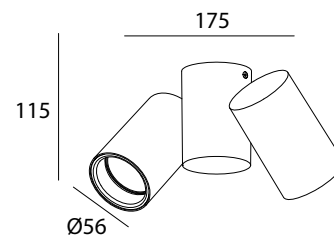

Folder	Wattage	Color	Material	Weight	Barcode
OS-LUP-2GU10-00	max. 2 x 20 W	blanc, blanco, weiß, bijeli	aluminium, aluminio, Aluminium, aluminij	480 g	5902801391316
OS-LUP-2GU10-10		noir, negro, schwarz, crna		480 g	5902801391439



FR Plafonnier  
ES Luminaria de techo  
DE Deckenleuchte  
HR Nadgradna svjetiljka

## SAKURA



White

Black

Accessoires  
Accesorios  
Zubehör  
Dodatna oprema:



ES111

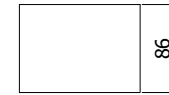
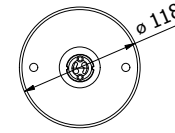

OS-SAKES111-10	max 20 W	blanc, blanco, weiß, bijeli	aluminium, aluminio, Aluminium, aluminij	350 g	5902801274350
OS-SAKES111-00		noir, negro, schwarz, crna			5902801274565



FR Plafonnier  
ES Luminaria de techo  
DE Deckenleuchte  
HR Nadgradna svjetiljka

## SAKURA

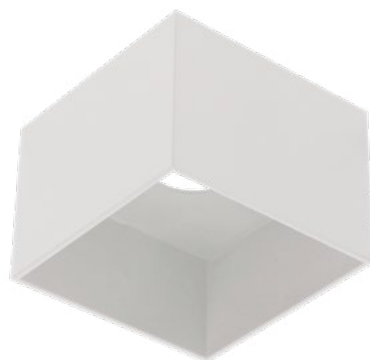

White

Black

Accessoires  
Accesorios  
Zubehör  
Dodatna oprema:



ES111

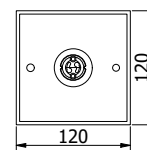

OS-SAKES111KW-10	max 20 W	blanc, blanco, weiß, bijeli	aluminium, aluminio, Aluminium, aluminij	500 g	5902801274527
OS-SAKES111KW-00		noir, negro, schwarz, crna			5902801274459



Dekorative fassungen





FR Plafonnier monté en applique  
ES Luminaria de techo de superficie  
DE Deckenaufbauleuchte  
HR Nadgradna svjetiljka

## PIREO N



White

Black

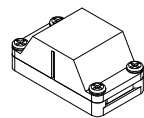

Accessoires  
Accesorios  
Zubehör  
Dodatna oprema:  
LZ-KOIZKO-10

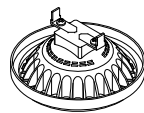

AR111

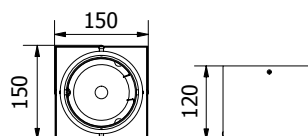

OP-PIREN1-00	max 50 W	Acier, acero, Stahl, čelik	blanc, blanco, weiß, bijeli	500 g	5902801248412
OP-PIREN1-20			noir, negro, schwarz, crna		5901867191151



FR Plafonnier monté en applique  
ES Luminaria de techo de superficie  
DE Deckenaufbauleuchte  
HR Nadgradna svjetiljka

## PIREO N



White

Black

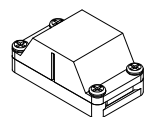

Accessoires  
Accesorios  
Zubehör  
Dodatna oprema:  
LZ-KOIZKO-10

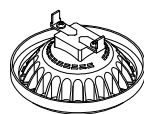

AR111

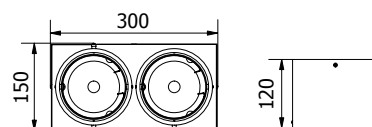

OP-PIREN2-00	max 2 x 50 W	Acier, acero, Stahl, čelik	blanc, blanco, weiß, bijeli	900 g	5902801248535
OP-PIREN2-20			noir, negro, schwarz, crna		5901867191151





FR Plafonnier  
ES Luminaria de techo  
DE Deckenleuchte  
HR Nadgradna svjetiljka

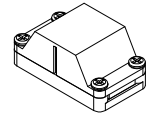

Accessoires  
Accesorios  
Zubehör  
Dodatna oprema:  
LZ-KOI2KO-10

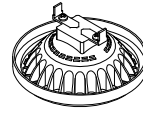

AR111

**ISUMI**



White

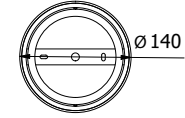

Black

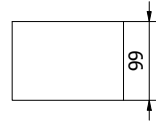

Dekorative fassungen



OS-ISUES111-10	max 50 W	blanc, blanco, weiß, bijeli	aluminium, aluminio, Aluminium, aluminij	490 g	5902801268090
OS-ISUES111-00		noir, negro, schwarz, crna			5902801268250



FR Plafonnier encastrable  
ES Luminaria de techo empotrable  
DE Deckeneinbauleuchte  
HR Ugradna svjetiljka

## PIREO

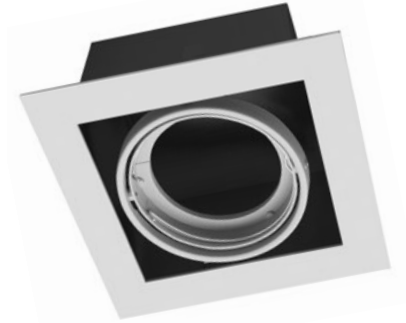

Black

Grey

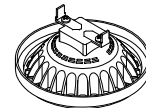

AR111

Accessoires  
Accesorios  
Zubehör  
Dodatna oprema:

**3**  
years  
warranty

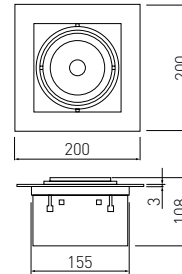

OP-PIREO1-20	max 50 W	Acier, acero, Stahl, čelik	noir, negro, schwarz, crna	500 g	5901867128287
OP-PIREO1-81			gris, gris, grau, sivi		5901867128386



FR Plafonnier encastrable  
ES Luminaria de techo empotrable  
DE Deckeneinbauleuchte  
HR Ugradna svjetiljka

## PIREO



Black

Grey

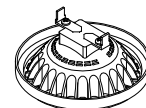

AR111

Accessoires  
Accesorios  
Zubehör  
Dodatna oprema:

**3**  
years  
warranty

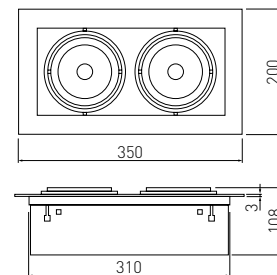

OP-PIREO2-20	max 2 x 50 W	Acier, acero, Stahl, čelik	noir, negro, schwarz, crna	920 g	5901867128300
OP-PIREO2-81			gris, gris, grau, sivi		5901867128409





FR Applique murale  
ES Luminaria de pared  
DE Wandleuchte  
HR Nadgradna spot svjetiljka

**NEW**

inside  
G9  
3 years warranty

CAMPIONE



White

Black

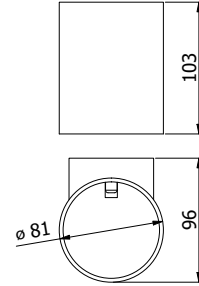

Dekorative fassungen



OS-CAMD40WG9OK-10	max 40 W	blanc, blanco, weiß, bijeli	aluminium, aluminio, Aluminium, aluminij	259 g	5902801412509
OS-CAMD40WG9OK-00		noir, negro, schwarz, crna			5902801412578

220-240 V 50-60 Hz IP20

FR Applique murale  
ES Luminaria de pared  
DE Wandleuchte  
HR Nadgradna spot svjetiljka

**NEW**

inside  
G9  
3 years warranty

CAMPIONE

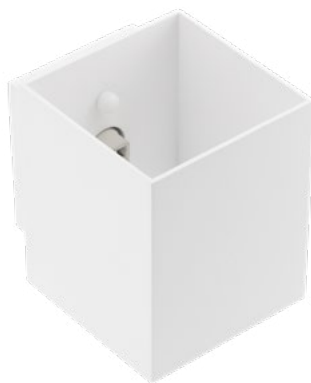

White

Black

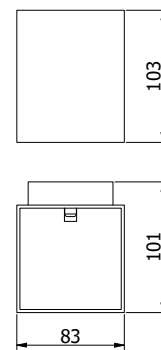

OS-CAMD40WG9KW-10	max 40 W	blanc, blanco, weiß, bijeli	aluminium, aluminio, Aluminium, aluminij	234 g	5902801412547
OS-CAMD40WG9KW-00		noir, negro, schwarz, crna			5902801438806

220-240 V 50-60 Hz IP20

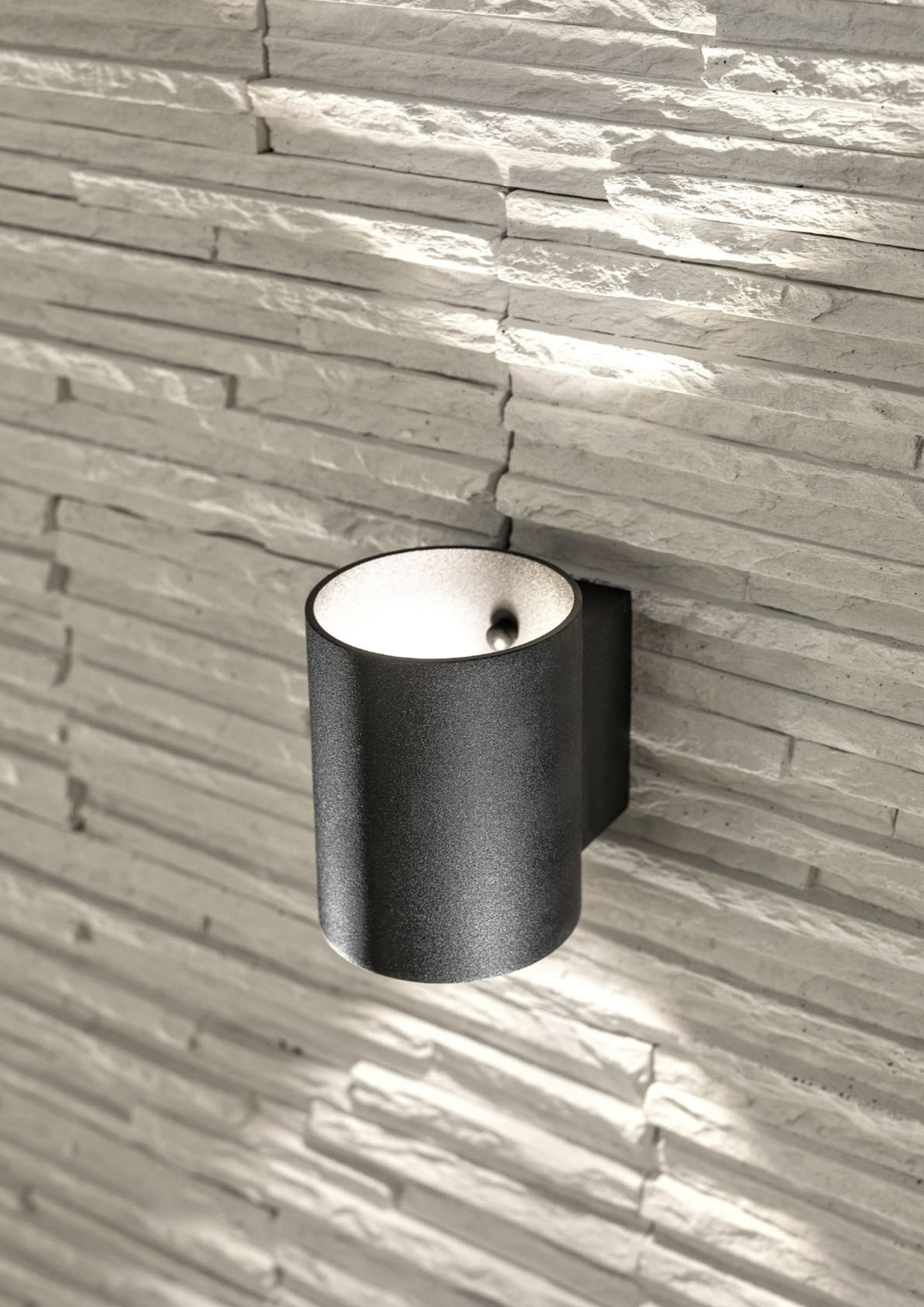



SPOTS  
LUMINARIAS PARA LA ILUMINACIÓN POR PUNTOS  
PUNKTSTRAHLER  
SPOT SVJETILJKE



FR Spot de plafond  
ES Luminaria de techo puntual  
DE Deckenpunktleuchte  
HR Spot ugradna svjetiljka

## PARMA

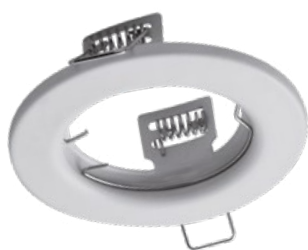

OP-PAST1-10



OP-PAST1-30



OP-PAST1-01



OP-PAST1-21



OP-PAST1-02

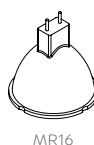
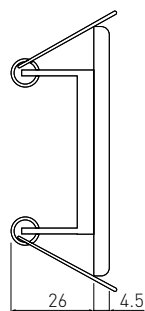
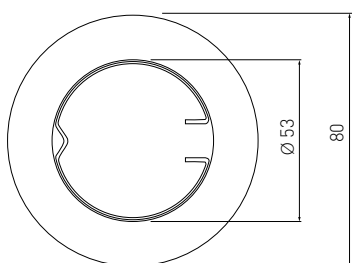

MR16

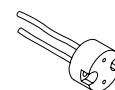

GZ-MR16-0000

Accessoires  
Accesorios  
Zubehör  
Dodatna  
oprema:



OP-PAST1-01	max 50 W	Acier, acero, Stahl, čelik	chrome, cromado, Chrom, krom	40 g	5908231384195
OP-PAST1-02			inox, inox, inox, inox		5908231384232
OP-PAST1-10			blanc, blanco, weiß, bijeli		5908231384171
OP-PAST1-21			chrome noir, negro cromado, Schwarzchrom, crni krom		5908231384188
OP-PAST1-30			patiné, pátina, Patina, patina		5908231384201





FR Spot de plafond  
 ES Luminaria de techo puntual  
 DE Deckenpunktleuchte  
 HR Spot ugradna svjetiljka

## PARMA III



OP-PADST3-10



OP-PADST3-01



OP-PADST3-52



OP-PADST3-61



OP-PADST3-21

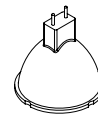
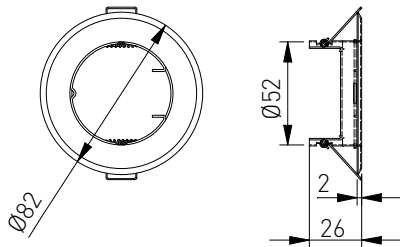

MR16

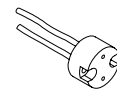

CZ-MR16-0000

Accessoires  
 Accesorios  
 Zubehör  
 Dodatna  
 oprema:

Dekorative fassungen



OP-PADST3-01		max 50 W	Acier, acero, Stahl, čelik	chrome, cromado, Chrom, krom	60 g	5902801387524
OP-PADST3-10	blanc, blanco, weiß, bijeli			5902801387449		
OP-PADST3-21	chrome noir, negro cromado, Schwarzchrom, crni krom			5902801387760		
OP-PADST3-52	satiné, satinado, Nickel matt, saten			5902801387555		
OP-PADST3-61	or ancient, oro antiguo, Altgold, staro zlato			5902801399794		



FR Spot de plafond, basculant  
 ES Luminaria de techo puntual, abatible  
 DE Decken-Punktleuchte schwenkbar  
 HR Spot ugradna svjetiljka s regulacijom kuta

## PARMA III



OP-PADRK3-10



OP-PADRK3-01



OP-PADRK3-52



OP-PADRK3-61



OP-PADRK3-21

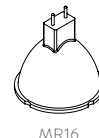
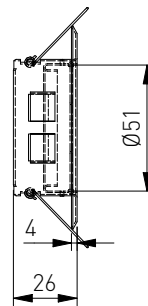
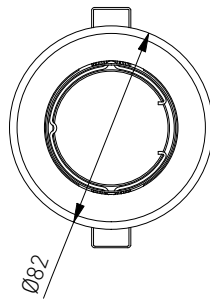

MR16

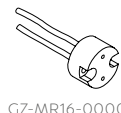

GZ-MR16-0000

Accessoires  
 Accesorios  
 Zubehör  
 Dodatna  
 oprema:



OP-PADRK3-01	max 50 W	Acier, acero, Stahl, čelik	chrome, cromado, Chrom, krom	60 g	5902801387616
OP-PADRK3-10			blanc, blanco, weiß, bijeli		5902801387517
OP-PADRK3-21			chrome noir, negro cromado, Schwarzchrom, crni krom		5902801387647
OP-PADRK3-52			satiné, satinado, Nickel matt, saten		5902801387609
OP-PADRK3-61			or ancient, oro antiguo, Altgold, staro zlato		5902801387593



FR Spot de plafond  
ES Luminaria de techo puntual  
DE Deckenpunktleuchte  
HR Spot ugradna svjetiljka

## PORTO

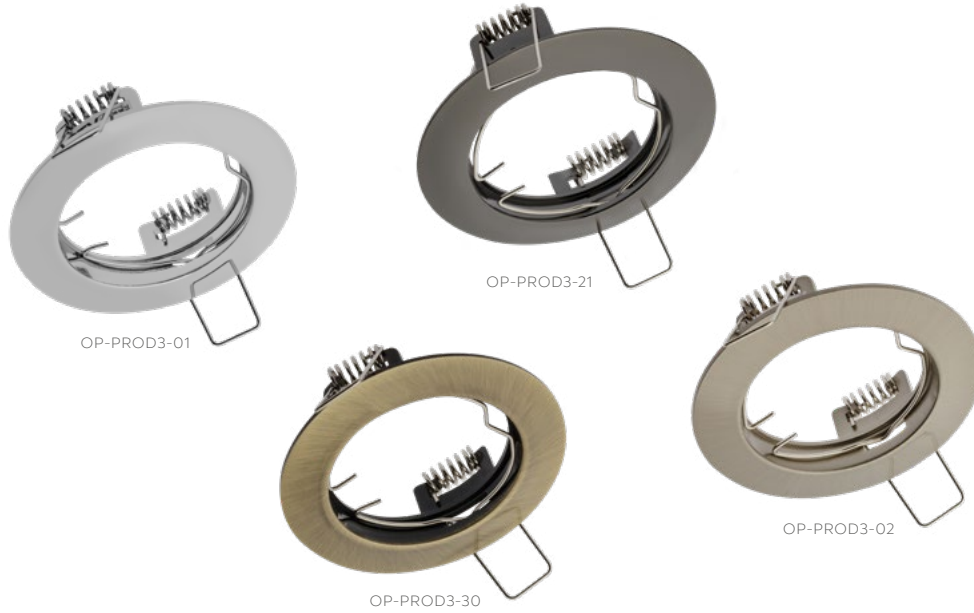

Dekorative fassungen

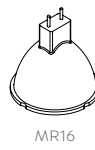
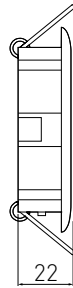
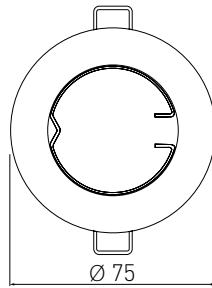

Accessoires  
Accesorios  
Zubehör  
Dodatna  
oprema:

Folder	Watt	Material	Finish	Weight	Barcode
OP-PROD3-01	max 50 W	aluminium, aluminio, Aluminium, aluminij	chrome, cromado, Chrom, krom	40 g	5908231384225
OP-PROD3-02			inox, inox, inox, inox		5908231384249
OP-PROD3-21			chrome noir, negro cromado, Schwarzchrom, crni krom		5908231384256
OP-PROD3-30			patiné, pátina, Patina, patina		5908231384263



FR Spot de plafond  
 ES Luminaria de techo puntual  
 DE Deckenpunktleuchte  
 HR Spot ugradna svjetiljka

## PORTO

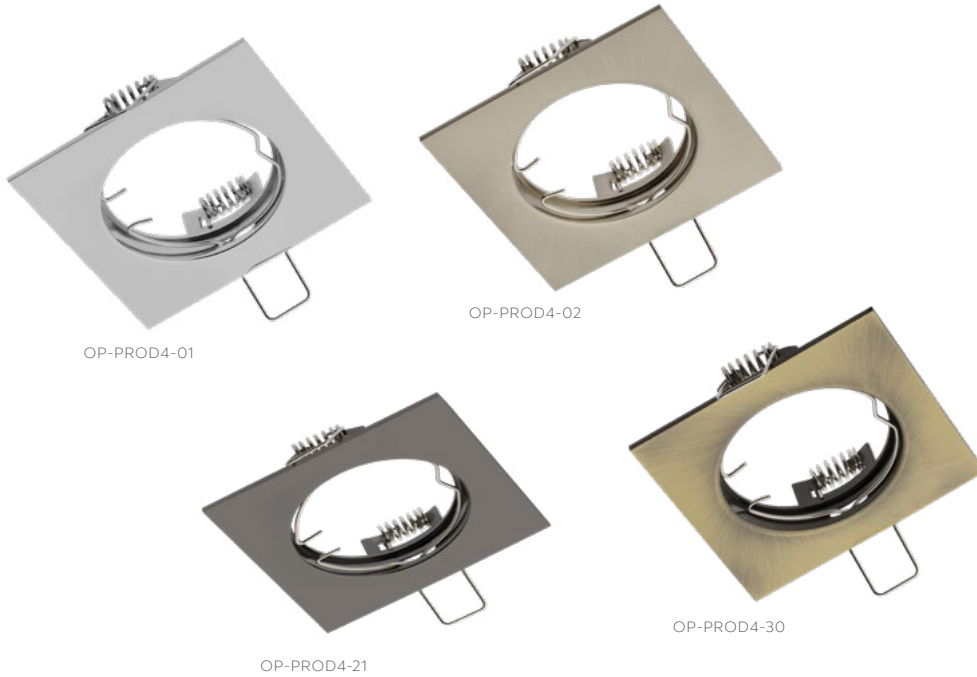

OP-PROD4-01

OP-PROD4-02

OP-PROD4-21

OP-PROD4-30

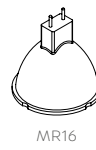
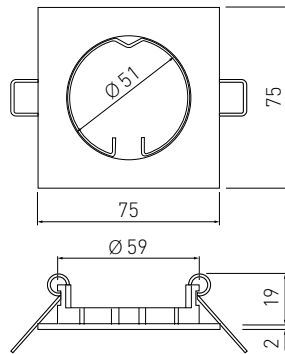

MR16

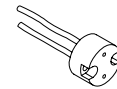

GZ-MR16-0000

Accessoires  
 Accesorios  
 Zubehör  
 Dodatna  
 oprema:

OP-PROD4-01	max 50 W	aluminium, aluminio, Aluminium, aluminij	chrome, cromado, Chrom, krom	50 g	5901867101617	
OP-PROD4-02			inox, inox, inox, inox		5901867101631	
OP-PROD4-21			chrome noir, negro cromado, Schwarzchrom, crni krom		5901867101624	
OP-PROD4-30			patiné, pátina, Patina, patina		5901867101648	





- FR Spot de plafond, basculant
- ES Luminaria de techo puntual, abatible
- DE Decken-Punktleuchte schwenkbar
- HR Spot ugradna svjetiljka s regulacijom kuta

## PORTO K



OP-PRAN5-01



OP-PRAN5-30



OP-PRAN5-21



OP-PRAN5-02

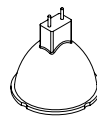
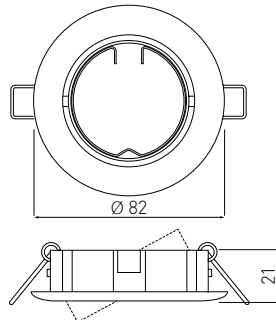

MR16

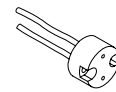

GZ-MR16-0000

Accessoires  
Accesorios  
Zubehör  
Dodatna  
oprema:

Dekorative fassungen



OP-PRAN5-01	max 50 W	aluminium, aluminio, Aluminium, aluminij	chrome, cromado, Chrom, krom	80 g	5908231384270
OP-PRAN5-02			inox, inox, inox, inox		5908231384287
OP-PRAN5-21			chrome noir, negro cromado, Schwarzchrom, crni krom		5908231384294
OP-PRAN5-30			patiné, pátina, Patina, patina		5908231384300



FR Spot de plafond, basculant  
 ES Luminaria de techo puntual, abatible  
 DE Decken-Punktleuchte schwenkbar  
 HR Spot ugradna svjetiljka s regulacijom kuta

## PORTO K

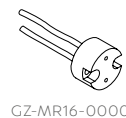
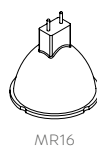
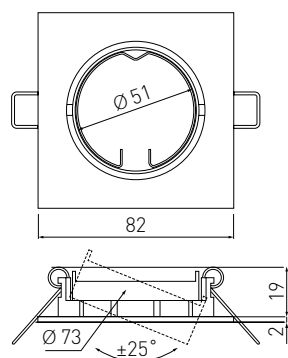

Accessoires  
 Accesorios  
 Zubehör  
 Dodatna  
 oprema:

Folder	Watt	Material	Finish	Weight	Barcode
OP-PRAN6-01	max 50 W	aluminium, aluminio, Aluminium, aluminij	chrome, cromado, Chrom, krom	60 g	5901867101655
OP-PRAN6-02			inox, inox, inox, inox		5901867101686
OP-PRAN6-21			chrome noir, negro cromado, Schwarzchrom, crni krom		5901867101679
OP-PRAN6-30			patiné, pátina, Patina, patina		5901867101662



Dekorative fassungen

FR Spot de plafond  
ES Luminaria de techo puntual  
DE Deckenpunktleuchte  
HR Spot ugradna svjetiljka

Accessoires  
Accesorios  
Zubehör  
Dodatna  
oprema:

## BRILLANTE



White

Black

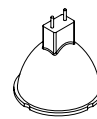

MR16

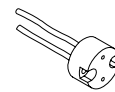

GZ-MR16-0000

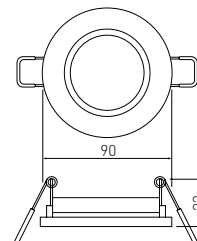

OP-OPROKR-10	max 50 W	Verre, vidrio, Glas, staklo	blanc, blanco, weiß, bijeli	130 g	5901867109699
OP-OPROKR-21			noir, negro, schwarz, crna		5901867109705



Dekorative fassungen



FR Spot de plafond  
ES Luminaria de techo puntual  
DE Deckenpunktleuchte  
HR Spot ugradna svjetiljka

Accessoires  
Accesorios  
Zubehör  
Dodatna  
oprema:

## BRILLANTE



White

Black

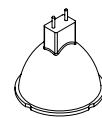

MR16

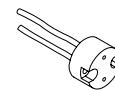

GZ-MR16-0000

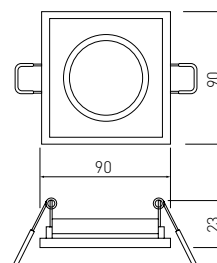

OP-OPRKWT-10	max 50 W	Verre, vidrio, Glas, staklo	blanc, blanco, weiß, bijeli	130 g	5901867109675
OP-OPRKWT-21			noir, negro, schwarz, crna		5901867109682





- FR Spot de plafond, basculant
- ES Luminaria de techo puntual, abatible
- DE Decken-Punktleuchte schwenkbar
- HR Spot ugradna svjetiljka s regulacijom kuta

Accessoires  
Accesorios  
Zubehör  
Dodatna  
oprema:

## MORENA

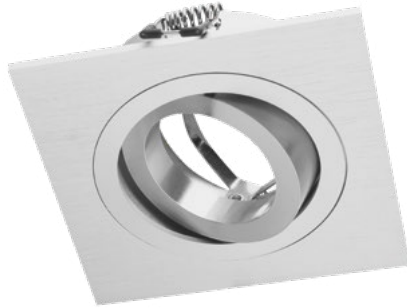

Silver

Black

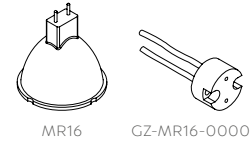

MR16 GZ-MR16-0000

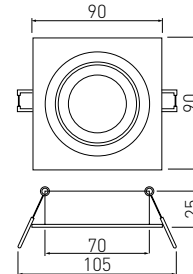

OP-OPRKW1-80	max 50 W	aluminium, aluminio, Aluminium, aluminij	argent, plata, silberfarben, srebrni	50 g	5901867127839
OP-OPRKW1-20			noir, negro, schwarz, crna		5901867127853



Dekorative fassungen



- FR Spot de plafond, basculant
- ES Luminaria de techo puntual, abatible
- DE Decken-Punktleuchte schwenkbar
- HR Spot ugradna svjetiljka s regulacijom kuta

Accessoires  
Accesorios  
Zubehör  
Dodatna  
oprema:

## MORENA



Silver

Black

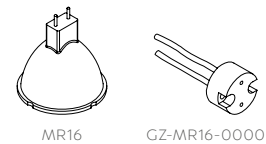

MR16 GZ-MR16-0000

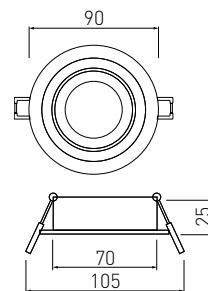

OP-OPROK1-80	max 50 W	aluminium, aluminio, Aluminium, aluminij	argent, plata, silberfarben, srebrni	50 g	5901867127792
OP-OPROK1-20			noir, negro, schwarz, crna		5901867127815





- FR Spot de plafond, basculant
- ES Luminaria de techo puntual, abatible
- DE Decken-Punktleuchte schwenkbar
- HR Spot ugradna svjetiljka s regulacijom kuta

Accessoires  
Accesorios  
Zubehör  
Dodatna  
oprema:

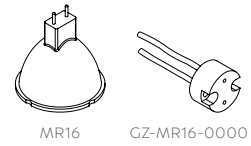

## CANNA



White

Black

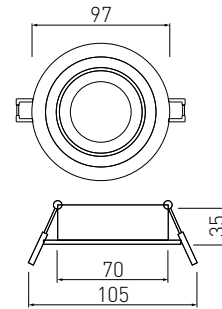

OP-CANOKB-10	max 50 W	aluminium, aluminio, Aluminium, aluminij	blanc, blanco, weiß, bijeli	55 g	5902801480225
OP-CANOKC-00			noir, negro, schwarz, crna		5902801478703



- FR Spot de plafond, basculant
- ES Luminaria de techo puntual, abatible
- DE Decken-Punktleuchte schwenkbar
- HR Spot ugradna svjetiljka s regulacijom kuta

Accessoires  
Accesorios  
Zubehör  
Dodatna  
oprema:

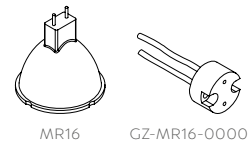

## CANNA



White

Black

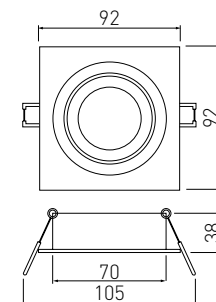

OP-CANKWB-10	max 50 W	aluminium, aluminio, Aluminium, aluminij	blanc, blanco, weiß, bijeli	55 g	5902801489570
OP-CANKWC-00			noir, negro, schwarz, crna		5902801489648





- FR Spot de plafond, basculant
- ES Luminaria de techo puntual, abatible
- DE Decken-Punktleuchte schwenkbar
- HR Spot ugradna svjetiljka s regulacijom kuta

## SALTO



Accessoires  
Accesorios  
Zubehör  
Dodatna  
oprema:

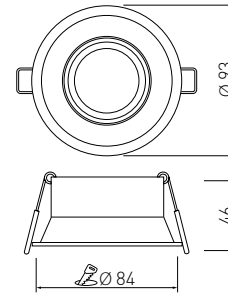
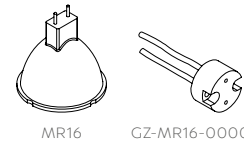

OP-SALOK-10	max 50 W	aluminium, aluminio, Aluminium, aluminij	blanc, blanco, weiß, bijeli	98 g	5901867197573



- FR Spot de plafond, basculant
- ES Luminaria de techo puntual, abatible
- DE Decken-Punktleuchte schwenkbar
- HR Spot ugradna svjetiljka s regulacijom kuta

## SALTO



Accessoires  
Accesorios  
Zubehör  
Dodatna  
oprema:

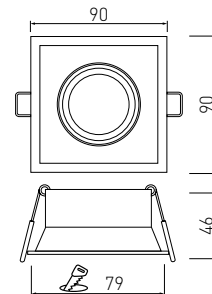
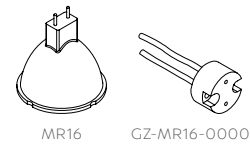

OP-SALKW-10	max 50 W	aluminium, aluminio, Aluminium, aluminij	blanc, blanco, weiß, bijeli	98 g	5901867197580





FR Spot de plafond  
ES Luminaria de techo puntual  
DE Deckenpunktleuchte  
HR Spot ugradna svjetiljka

Accessoires  
Accesorios  
Zubehör  
Dodatna  
oprema:

## PALACE II

360°

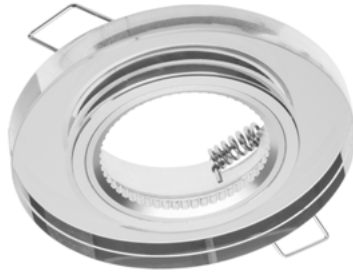

White

Black

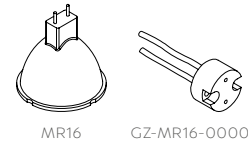

MR16

GZ-MR16-0000

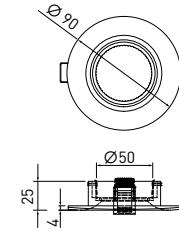

OP-PALACEDOK-10	max 50 W	Verre, vidrio, Glas, staklo	blanc, blanco, weiß, bijeli	125 g	5902801130038
OP-PALACEDOK-20			noir, negro, schwarz, crna		5902801130083



FR Spot de plafond  
ES Luminaria de techo puntual  
DE Deckenpunktleuchte  
HR Spot ugradna svjetiljka

Accessoires  
Accesorios  
Zubehör  
Dodatna  
oprema:

## PALACE II

360°

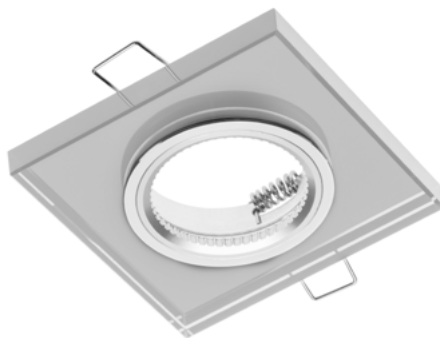

White

Black

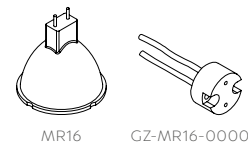

MR16

GZ-MR16-0000

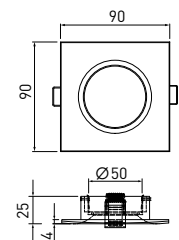

OP-PALACEDKW-10	max 50 W	Verre, vidrio, Glas, staklo	blanc, blanco, weiß, bijeli	165 g	5902801130052
OP-PALACEDKW-20			noir, negro, schwarz, crna		5902801130069



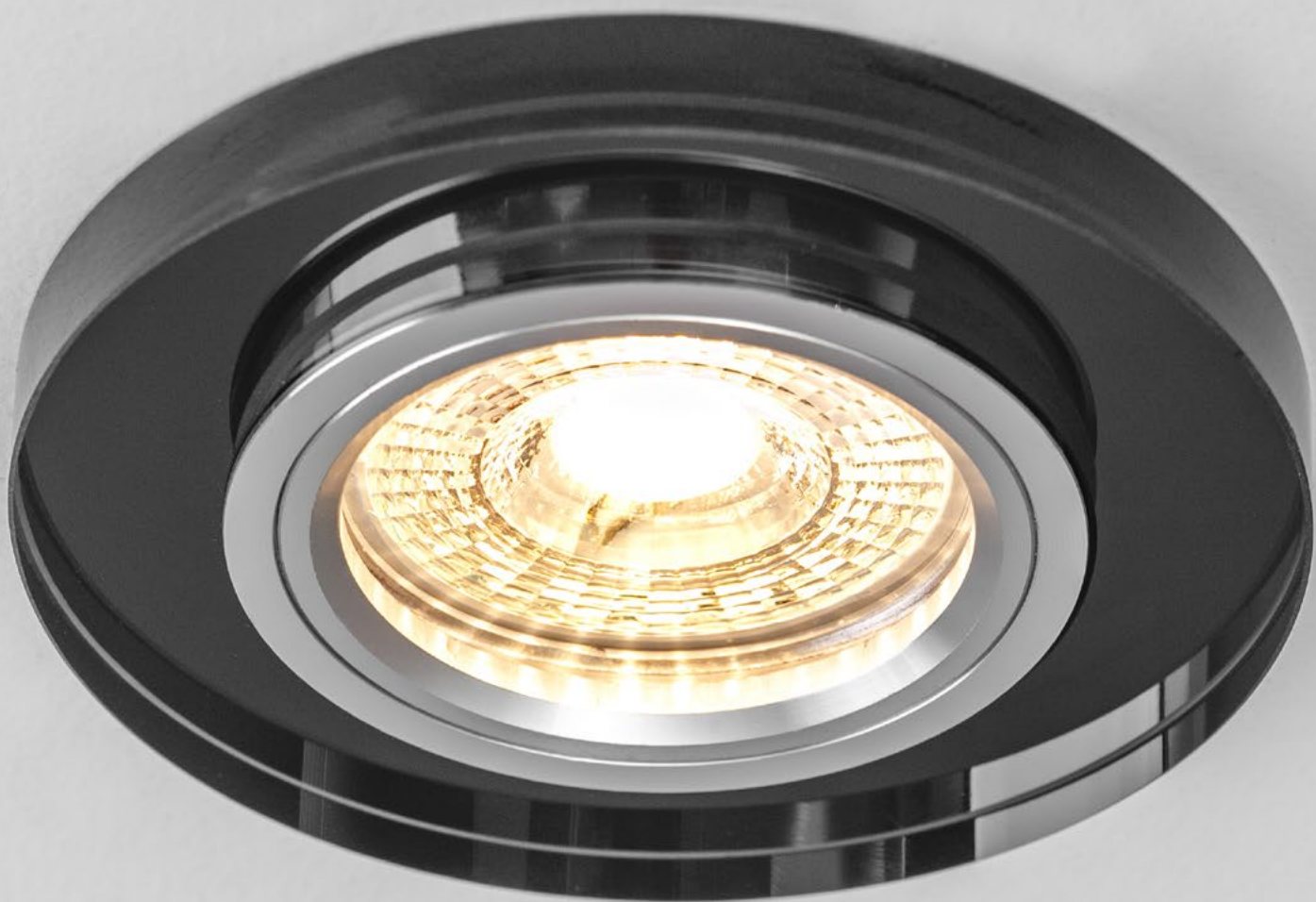



FR Spot de plafond  
 ES Luminaria de techo puntual  
 DE Deckenpunktleuchte  
 HR Spot ugradna svjetiljka

**MAREA**

Accessoires  
 Accesorios  
 Zubehör  
 Dodatna  
 oprema:

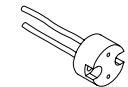
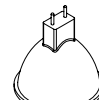

MR16

GZ-MR16-0000

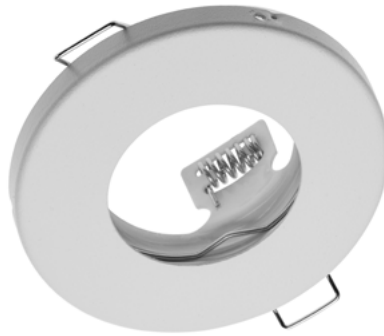

White

Inox

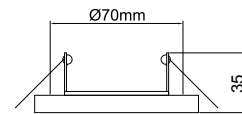
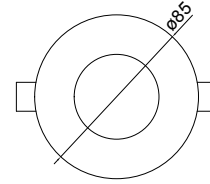

OP-MAROK-10	max 50 W	Acier, acero, Stahl, čelik	blanc, blanco, weiß, bijeli	95 g	5901867197597
OP-MAROK-02			inox, inox, inox, inox		5901867197603



Dekorative fassungen



FR Spot de plafond  
ES Luminaria de techo puntual  
DE Deckenpunktleuchte  
HR Spot ugradna svjetiljka

**ARIES**

Accessoires  
Accesorios  
Zubehör  
Dodatna oprema:

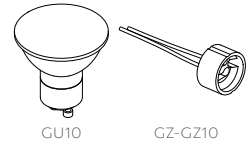

OP-ARIOK-11



OP-ARIOK-22



OP-ARIOK-23



OP-ARIOK-13



OP-ARIOK-11	max 20 W	PC	noir, negro, schwarz, crna	50 g	5902801440564
OP-ARIOK-22			chrome noir, negro cromado, Schwarzchrom, crni krom		5902801440250
OP-ARIOK-23			chrome, cromado, Chrom, krom		5902801440267
OP-ARIOK-13			or ancient, oro antiguo, Altgold, staro zlato		5902801441295



Dekorative fassungen

FR Spot de plafond  
ES Luminaria de techo puntual  
DE Deckenpunktleuchte  
HR Spot ugradna svjetiljka

**ARIES**

Accessoires  
Accesorios  
Zubehör  
Dodatna oprema:

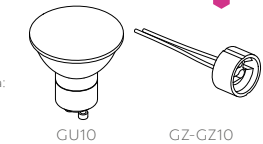

OP-ARIKW-11



OP-ARIKW-22



OP-ARIKW-23



OP-ARIKW-13



OP-ARIKW-11	max 20 W	PC	blanc/noir, blanco/negro, weiß/schwarz, bijeli/crna	60 g	5902801442582
OP-ARIKW-22			chrome noir, negro cromado, Schwarzchrom, crni krom		5902801442810
OP-ARIKW-23			chrome, cromado, Chrom, krom	50 g	5902801441790
OP-ARIKW-13			or ancient, oro antiguo, Altgold, staro zlato		5902801400131





FR Spot de plafond  
ES Luminaria de techo puntual  
DE Deckenpunktleuchte  
HR Spot ugradna svjetiljka

## AURORA

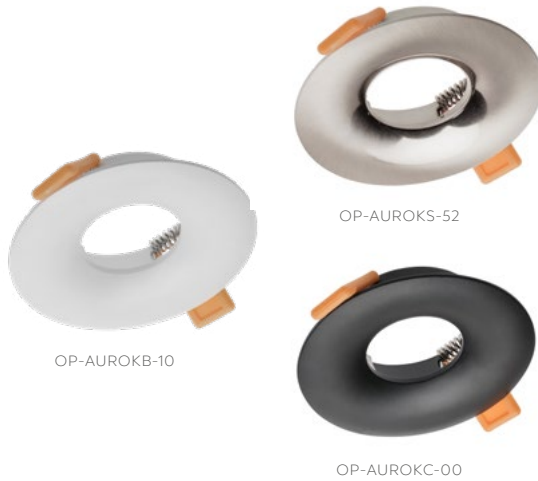

Accessoires  
Accesorios  
Zubehör  
Dodatna  
oprema:

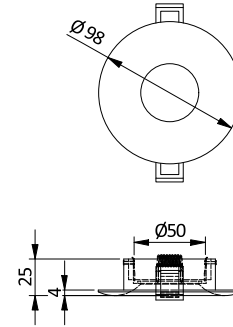
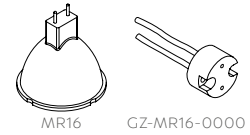

OP-AUROKB-10	max 50 W	aluminium, aluminio, Aluminium, aluminij	blanc, blanco, weiß, bijeli	100 g	5902801238819
OP-AUROKS-52			satiné, satinado, Nickel matt, saten		5902801239731
OP-AUROKC-00			noir, negro, schwarz, crna		5902801267895



Dekorative fassungen



FR Spot de plafond  
ES Luminaria de techo puntual  
DE Deckenpunktleuchte  
HR Spot ugradna svjetiljka

## AURORA

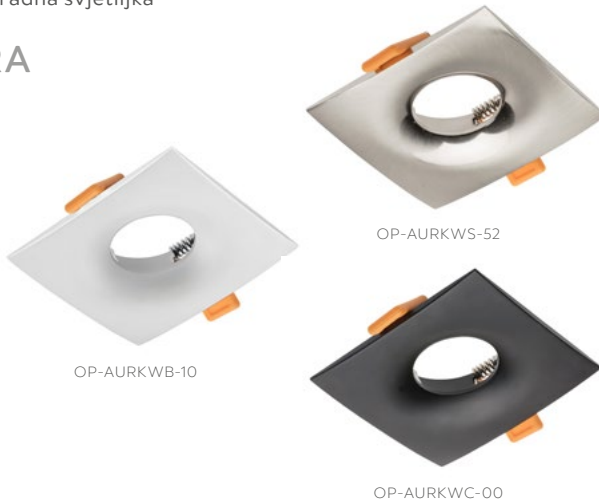

Accessoires  
Accesorios  
Zubehör  
Dodatna  
oprema:

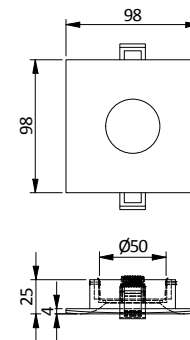
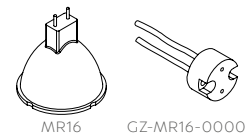

OP-AURKWB-10	max 50 W	aluminium, aluminio, Aluminium, aluminij	blanc, blanco, weiß, bijeli	130 g	5902801239991
OP-AURKWS-52			satiné, satinado, Nickel matt, saten		5902801240034
OP-AURKWC-00			noir, negro, schwarz, crna		5902801267901









- FR Spot de plafond, basculant
- ES Luminaria de techo puntual, abatible
- DE Decken-Punktleuchte schwenkbar
- HR Spot ugradna svjetiljka s regulacijom kuta

## LINTO



Accessoires  
Accesorios  
Zubehör  
Dodatna  
oprema:

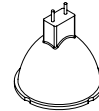

MR16

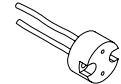

GZ-MR16-0000

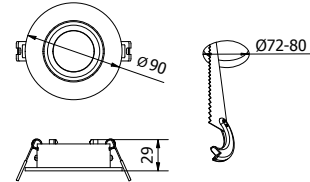

OP-LINTOK-00	max 20 W LED only	PC	noir, negro, schwarz, crna	40 g	5902801320170
OP-LINTOK-10			blanc, blanco, weiß, bijeli		5902801320132
OP-LINTOK-52			blanc/noir, blanco/negro, weiß/schwarz, bijeli/crna		5902801320484



Dekorative fassungen



- FR Spot de plafond
- ES Luminaria de techo puntual
- DE Deckenpunktleuchte
- HR Spot ugradna svjetiljka



## KERLA



Accessoires  
Accesorios  
Zubehör  
Dodatna  
oprema:

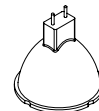

MR16

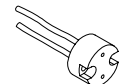

GZ-MR16-0000

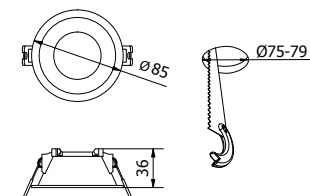

OP-KERLKW-10	max 20 W LED only	PC	blanc, blanco, weiß, bijeli	25 g	5902801320026
OP-KERLKW-00			noir, negro, schwarz, crna		5902801320507



FR Spot de plafond  
 ES Luminaria de techo puntual  
 DE Deckenpunktleuchte  
 HR Spot ugradna svjetiljka

**ELVA**



OP-ELVAOBB-10	max 20 W	aluminium/Verre, aluminio/vidrio, Aluminium/Glas, aluminij/staklo	blanc, blanco, weiß, bijeli	145 g	5902801365997
OP-ELVAOCC-00			noir, negro, schwarz, crna		5902801366017
OP-ELVAOBC-11			blanc/noir, blanco/negro, weiß/schwarz, bijeli/crna		5902801366215
OP-ELVAOBM-13			blanc/Or, blanco/oro, weiß/gold, bijeli/zlato		5902801366239
OP-ELVAOCM-03			noir/doré, negro/oro, schwarz/gold, crna/zlatnim		5902801366611





FR Spot de plafond  
ES Luminaria de techo puntual  
DE Deckenpunktleuchte  
HR Spot ugradna svjetiljka

## ALESSIO



OP-ALSOK-10



OP-ALSOK-52



OP-ALSOK-00

Accessoires  
Accesorios  
Zubehör  
Dodatna  
oprema:

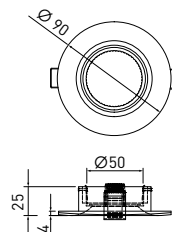
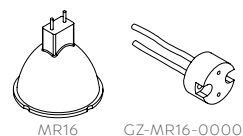

OP-ALSOK-10	max 50 W	aluminium, aluminio, Aluminium, aluminij	blanc, blanco, weiß, bijeli	100 g	5902801242250
OP-ALSOK-00			noir, negro, schwarz, crna		5902801242618
OP-ALSOK-52			satiné, satinado, Nickel matt, saten		5902801242687



FR Spot de plafond  
ES Luminaria de techo puntual  
DE Deckenpunktleuchte  
HR Spot ugradna svjetiljka

## ALESSIO



OP-ALSKW-10



OP-ALSKW-52



OP-ALSKW-00

Accessoires  
Accesorios  
Zubehör  
Dodatna  
oprema:

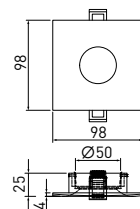
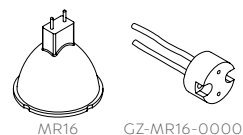

OP-ALSKW-10	max 50 W	aluminium, aluminio, Aluminium, aluminij	blanc, blanco, weiß, bijeli	130 g	5902801243479
OP-ALSKW-00			noir, negro, schwarz, crna		5902801242007
OP-ALSKW-52			satiné, satinado, Nickel matt, saten		5902801243585











- FR Spot de plafond, basculant
- ES Luminaria de techo puntual, abatible
- DE Decken-Punktleuchte schwenkbar
- HR Spot ugradna svjetiljka s regulacijom kuta

## RUBIO



OP-RUBIOKW1-10

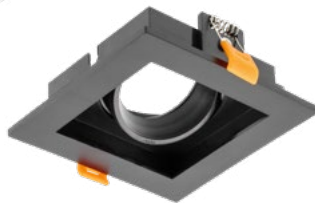

OP-RUBIOKW1-00

Accessoires  
Accesorios  
Zubehör  
Dodatna  
oprema:



MR16

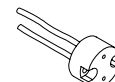

GZ-MR16-0000

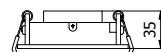
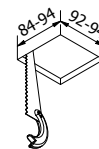
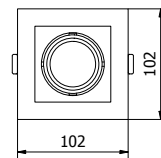

OP-RUBIOKW1-10	max 10 W LED only	PC	blanc, blanco, weiß, bijeli	42 g	5902801319655
OP-RUBIOKW1-00			noir, negro, schwarz, crna		5902801319600



- FR Spot de plafond, basculant
- ES Luminaria de techo puntual, abatible
- DE Decken-Punktleuchte schwenkbar
- HR Spot ugradna svjetiljka s regulacijom kuta



## RUBIO



OP-RUBIOKW2-10



OP-RUBIOKW2-00

Accessoires  
Accesorios  
Zubehör  
Dodatna  
oprema:



MR16

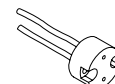

GZ-MR16-0000

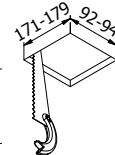
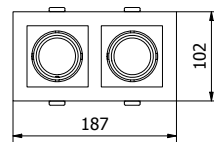

OP-RUBIOKW2-10	max 10 W LED only	PC	blanc, blanco, weiß, bijeli	84 g	5902801319686
OP-RUBIOKW2-00			noir, negro, schwarz, crna		5902801319846





FR Luminaire d'escalier LED  
 ES Luminaria LED para escalera  
 DE LED-Treppenleuchten  
 HR LED stubišna svjetiljka

ESCADA

LED  
 inside  
 0,8 W  
 3 years warranty

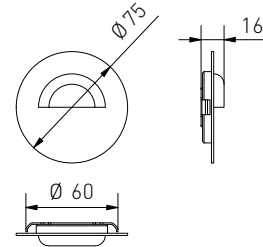

Dekorative fassungen



LD-ESOA084-51	0,8 W	● 4000 K	70 lm	inox, inox, inox, inox	5902801211119

FR Luminaire d'escalier LED  
 ES Luminaria LED para escalera  
 DE LED-Treppenleuchten  
 HR LED stubišna svjetiljka

ESCADA

LED  
 inside  
 0,8 W  
 3 years warranty

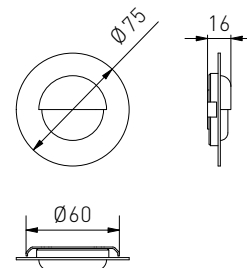

LD-ESOB084-51	0,8 W	● 4000 K	70 lm	inox, inox, inox, inox	5902801210990







FR Luminaire d'escalier LED  
 ES Luminaria LED para escalera  
 DE LED-Treppenleuchten  
 HR LED stubišna svjetiljka

ESCADA

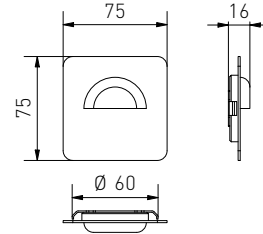
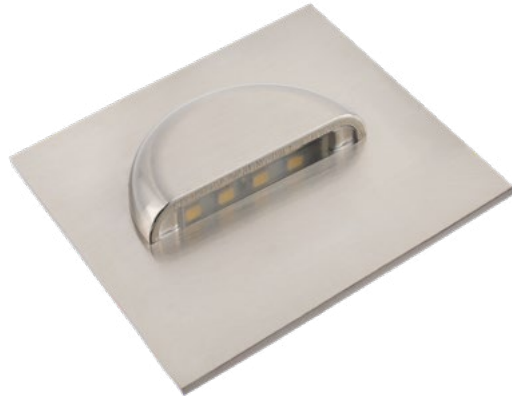

LED  
 inside  
 0,8 W  
 3 years warranty

Dekorative fassungen



LD-ESKA084-51	0,8 W	● 4000 K	70 lm	inox, inox, inox, inox	5902801211270									

FR Luminaire d'escalier LED  
 ES Luminaria LED para escalera  
 DE LED-Treppenleuchten  
 HR LED stubišna svjetiljka

ESCADA

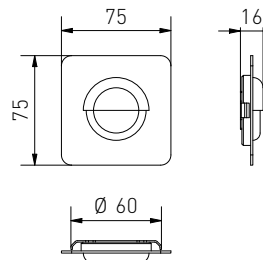

LED  
 inside  
 0,8 W  
 3 years warranty

LD-ESKB084-51	0,8 W	● 4000 K	70 lm	inox, inox, inox, inox	5902801211201									

FR Luminaire sur bras  
ES Luminaria para muebles altos  
DE Schrankaufbauleuchte  
HR LED svjetiljka s nosačem

## KATANI

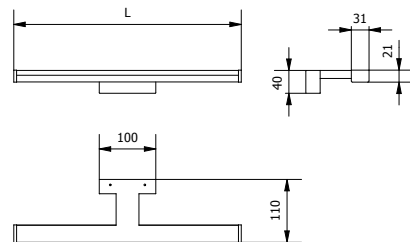
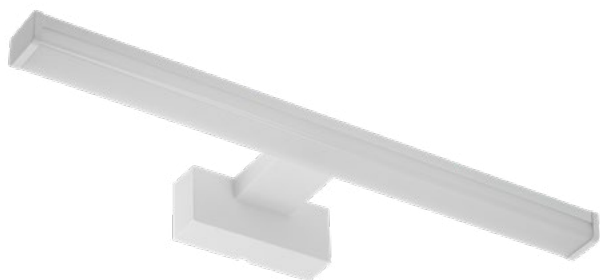

					mm			
LD-KAT400-01		8 W	640 lm	● 4000 K	400	chrome, cromado, Chrom, krom	5902801399077	
LD-KAT600-01		12 W	960 lm		600			5902801399299
LD-KAT400-10		8 W	640 lm		400	noir, negro, schwarz, crna	5902801399428	
LD-KAT600-10		12 W	960 lm		600		aluminium + PC, aluminio + PC, Aluminium + PC, aluminij + PC,	5902801399336
LD-KAT400-00		8 W	640 lm		400	blanc, blanco, weiß, bijeli		5902801399695
LD-KAT600-00		12 W	960 lm		600			



Dekorative fassungen







ECLAIRAGE MURAL ET JARDIN  
LUMINARIAS PARA JARDÍN Y FACHADA  
GARTEN- UND FASSADENLEUCHTEN  
VANJSKA RASVJETA – VRTNE I ZIDNE SVJETILJKE

FR Luminaire de facade  
ES Luminaria para fachada  
DE Fassadenleuchte  
HR Zidna svjetiljka

## MILAN



OS-MILA00A-00



OS-MILA00U-00

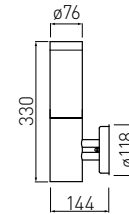

OS-MILA00A-00

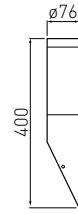

OS-MILA00U-00



OS-MILA00A-00	max 20 W	Acier Inox + PC, acero inoxidable + PC, rostfreier Stahl + PC, nehrđajući čelik + PC	inox, inox, inox, inox	502 g	5901867199218
OS-MILA00U-00				358 g	5901867199195



FR Luminaire de jardin  
ES Luminaria para jardín  
DE Gartenleuchte  
HR Vrtna svjetiljka

## MILAN



OS-MILA45P-00



OS-MILA10P-00

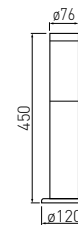

OS-MILA45P-00

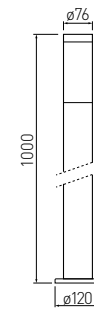

OS-MILA10P-00



OS-MILA10P-00	max 20 W	Acier Inox + PC, acero inoxidable + PC, rostfreier Stahl + PC, nehrđajući čelik + PC	inox, inox, inox, inox	876 g	5901867199256
OS-MILA45P-00				463 g	5901867199232





FR Luminaire de jardin  
ES Luminaria para jardín  
DE Gartenleuchte  
HR Vrtna svjetiljka

# CORTA

Dekorative fassungen

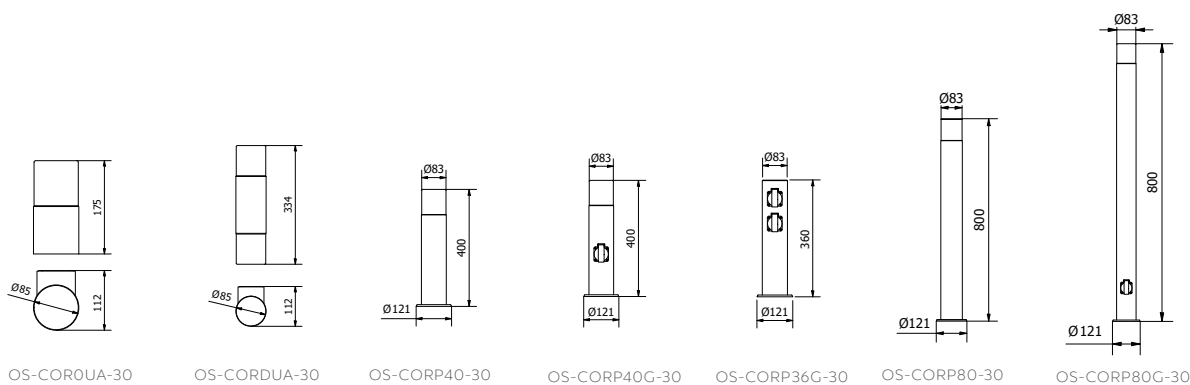

OS-COR0UA-30	max 25 W	aluminium + PC, aluminio + PC, Aluminium + PC, aluminij + PC,	444 g	5902801288951
OS-CORDUA-30	2 x max 25 W		700 g	5902801289002
OS-CORP40-30	max 25 W		711 g	5902801288944
OS-CORP40G-30			711 g	5902801227417
OS-CORP36G-30	-		630 g	5902801336973
OS-CORP80-30	max 25 W		1307 g	5902801289088
OS-CORP80G-30			1307 g	5902801309113









# KERTA

Dekorative fassungen



OS-KERTOUA-30



OS-KERTP40-30



OS-KERTP80-30

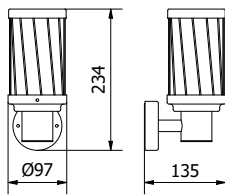

OS-KERTOUA-30

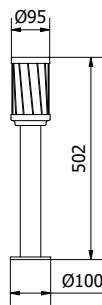

OS-KERTP40-30

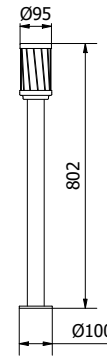

OS-KERTP80-30

OS-KERTOUA-30	max 12 W	aluminium + PC, aluminio + PC, Aluminium + PC, aluminij + PC,	690 g	5902801227325	
OS-KERTP40-30			700 g	5902801227455	
OS-KERTP80-30			1350 g	5902801227493	









# KEMI

Dekorative fassungen



OS-KEMIOUA-30

OS-KEMIP40-30

OS-KEMIP80-30

OS-KEMIP40G-30

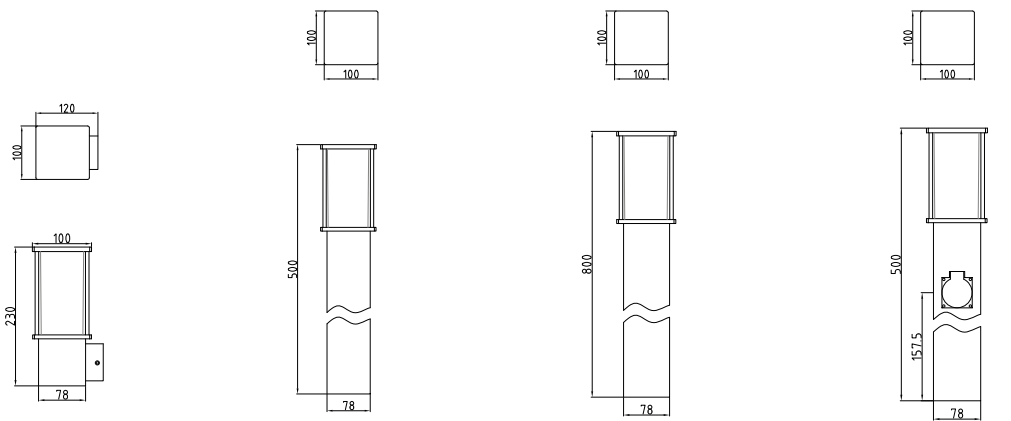

OS-KEMIOUA-30

OS-KEMIP40-30

OS-KEMIP80-30

OS-KEMIP40G-30

OS-KEMIOUA-30	max 15 W		Acier Inox + PC, acero inoxidable + PC, rostfreier Stahl + PC, nehrđajući čelik + PC	780 g	5902801336225
OS-KEMIP40-30				1120 g	5902801336102
OS-KEMIP80-30				1370 g	5902801336294
OS-KEMIP40G-30*				1820 g	5902801336003









FR Luminaire de jardin  
ES Luminaria para jardín  
DE Gartenleuchte  
HR Vrtno rasvjetno tijelo

**MEDIO**

Dekorative fassungen



OS-MED0AU-30

OS-MED0AUP-30

OS-MEDP50-30

OS-MEDP50P-30

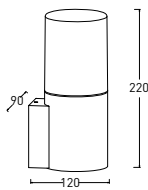

OS-MED0AU-30

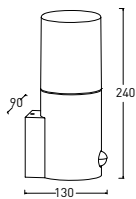

OS-MED0AUP-30

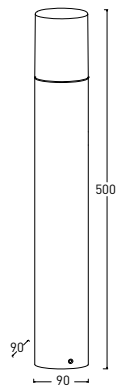

OS-MEDP50-30

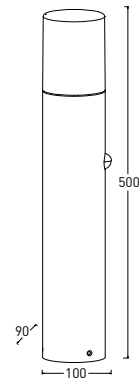

OS-MEDP50P-30

OS-MED0AU-30	MAX 15 W	aluminium + PC, aluminio + PC, Aluminium + PC, aluminij + PC,	670 g	5902801337475
OS-MED0AUP-30*			720 g	5902801337406
OS-MEDP50-30			1100 g	5902801363566
OS-MEDP50P-30*			1150g	5902801363542











FR Luminaire de jardin  
ES Luminaria para jardín  
DE Gartenleuchte  
HR Vrtna svjetiljka

**LARGO**



Dekorative fassungen



OS-LARG0UA-30

OS-LARGP40-30

OS-LARGP40G-30

OS-LARGP40P-30

OS-LARGP36G-30

OS-LARGP80-30

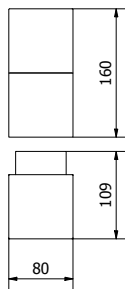

OS-LARG0UA-30

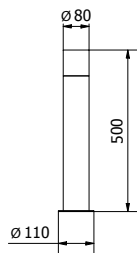

OS-LARGP40-30

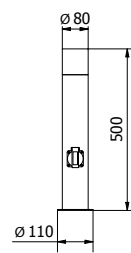

OS-LARGP40G-30  
OS-LARGP40P-30  
OS-LARGP36G-30

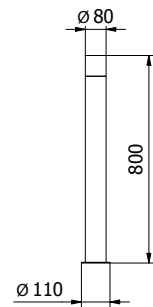

OS-LARGP80-30

Folder	W	IP	Material	Socket	Weight	Barcode	
OS-LARG0UA-30	max 15 W	44	aluminium + PC, aluminio + PC, Aluminium + PC, aluminij + PC,	-	450 g	5902801335259	
OS-LARGP40-30					820 g	5902801335686	
OS-LARGP80-30					1120 g	5902801335990	
OS-LARGP40G-30	990 g	5902801336232					
OS-LARGP36G-30	-	54			schuko x4	830 g	5902801337055
OS-LARGP40P-30*	max 15 W	44			-	1005 g	5902801336997







FR Luminaire de jardin  
ES Luminaria para jardín  
DE Gartenleuchte  
HR Vrtno rasvjetno tijelo

**TORO**

Dekorative fassungen



OS-TOR0AU-00



OS-TORP50-00



OS-TORP80-00

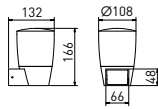

OS-TOR0AU-00

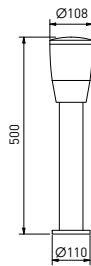

OS-TORP50-00

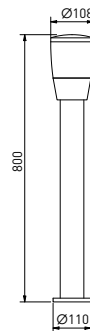

OS-TORP80-00

OS-TOR0AU-00	max 15 W	aluminium + PC, aluminio + PC, Aluminium + PC, aluminij + PC,	noir, negro, schwarz, crna	540 g	5902801337048
OS-TORP50-00				700 g	5902801337000
OS-TORP80-00				870 g	5902801337116



# LUSTINO



OS-USTI0UD-30

OS-USTIP40-30

OS-USTIP80-30

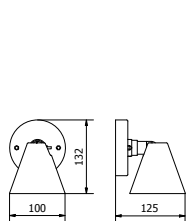

OS-USTI0UD-30

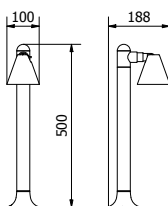

OS-USTIP40-30

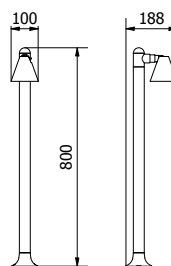

OS-USTIP80-30

Dekorative fassungen

OS-USTI0UD-30	max 20 W	aluminium, aluminio, Aluminium, aluminij	5902801335327
OS-USTIP40-30			5902801335273
OS-USTIP80-30			5902801335396





FR Luminaire de jardin  
ES Luminaria para jardín  
DE Gartenleuchte  
HR Vrtno rasvjetno tijelo

**GRANDE**



OS-GRA0DA-00



OS-GRA0UA-00



OS-GRA00P-00



OS-GRA31P-00

Dekorative fassungen

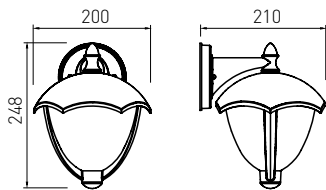

OS-GRA0DA-00

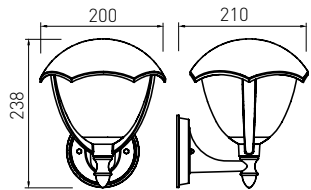

OS-GRA0UA-00

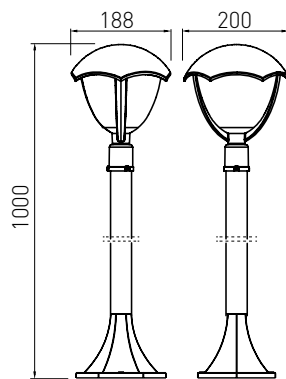

OS-GRA00P-00

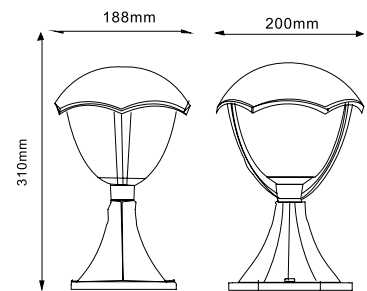

OS-GRA31P-00

Product Code	Power	Material	Color	Weight	Barcode
OS-GRA0DA-00	max 60 W	aluminium + PC, aluminio + PC, Aluminium + PC, aluminij + PC,	noir, negro, schwarz, crna	627 g	5901867199133
OS-GRA0UA-00				1020 g	5901867199119
OS-GRA00P-00				627 g	5901867199157
OS-GRA31P-00				540 g	5902801337390









# MARINA



OS-MARINADA-00



OS-MARINAUA-00



OS-MARINAH-00



OS-MARINAP-00



OS-TMG30CM-00



OS-MARINAP3-00

Dekorative fassungen

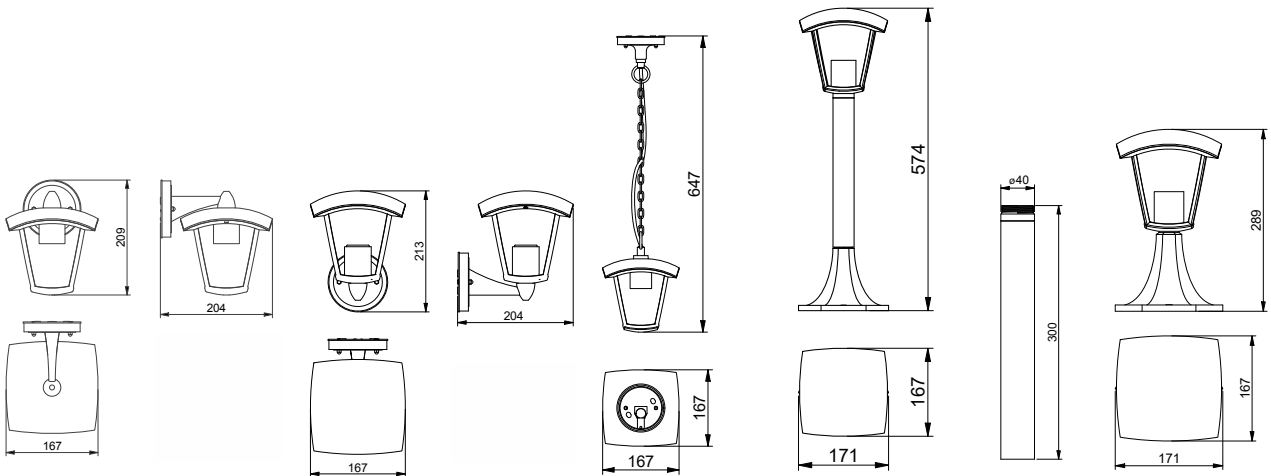

OS-MARINADA-00

OS-MARINAUA-00

OS-MARINAH-00

OS-MARINAP-00

OS-TMG30CM-00

OS-MARINAP3-00

OS-MARINAP3-00	max 20 W	aluminium + PC, aluminio + PC, Aluminium + PC, aluminij + PC,	noir, negro, schwarz, crna	750 g	5902801205804	
OS-MARINADA-00					5902801205583	
OS-MARINAUA-00					5902801205637	
OS-MARINAP-00					5902801205798	
OS-TMG30CM-00	-	aluminium, aluminio, Aluminium, aluminij		200 g	5902801224645	
OS-MARINAH-00	max 20 W	aluminium + Verre, aluminio + vidrio, Aluminium + Glas, aluminij + staklo		750 g	5902801205743	







FR Luminaire de facade  
ES Luminaria para fachada  
DE Fassadenleuchte  
HR Zidna svjetiljka

## TOSKANA



Black

Grey

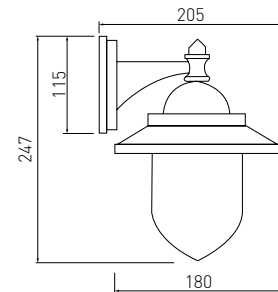

Dekorative fassungen



OS-TOSODA-00	max 60 W	aluminium + PC, aluminio + PC, Aluminium + PC, aluminij + PC,	noir, negro, schwarz, crna	627 g	5901867199171
OS-TOSODA-80			gris, gris, grau, sivi		5902801456718



FR Luminaire de facade  
ES Luminaria para fachada  
DE Fassadenleuchte  
HR Zidna svjetiljka

## ASTRIT



Black

Grey

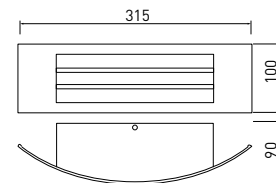

OS-ASTRITE27-20	max 14 W	Plastique, plastico, Kunststoff, plastika	noir, negro, schwarz, crna	450 g	5901867190826
OS-ASTRITE27-80			gris, gris, grau, sivi		5901867190802









FR Luminaire de facade  
ES Luminaria para fachada  
DE Fassadenleuchte  
HR Zidna svjetiljka

## ESO



Inox

Black

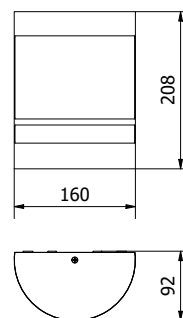

Jeu de lettres et de chiffres inclus.  
Conjunto de letras y números incluidos.  
Satz Buchstaben und Zahlen enthalten.  
Skup slova i brojeva u Prilogu.



OS-ESOE2711-80	max 11 W	PC	inox, inox, inox, inox	600 g	5902801227363
OS-ESOE2711-20			noir, negro, schwarz, crna		5902801227318



FR Luminaire de facade  
ES Luminaria para fachada  
DE Fassadenleuchte  
HR Zidna svjetiljka

## VENTANA



OS-VENTANAH-00



OS-VENTANAU-00

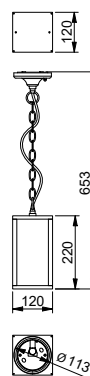

OS-VENTANAH-00

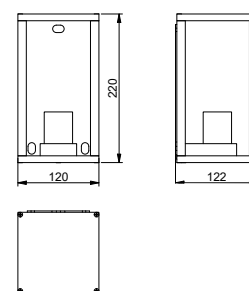

OS-VENTANAU-00



OS-VENTANAH-00	max 20 W	aluminium + Verre, aluminio + vidrio, Aluminium + Glas, aluminij + staklo	noir, negro, schwarz, crna	1312g	5902801225055
OS-VENTANAU-00				1140g	5902801282423



A glowing cylindrical light fixture is mounted on a wall. The fixture has a white, illuminated body with three horizontal brushed metal bands. The text '5A' is printed in a bold, black, sans-serif font on the upper portion of the cylinder. The wall is made of light-colored, perforated tiles.

**5A**



FR Plafonnier  
ES Luminaria de techo  
DE Deckenleuchte  
HR Stropno rasvjetno tijelo

## LENTO

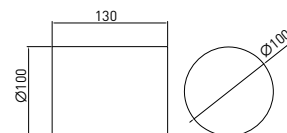

Dekorative fassungen



OS-LEN100OKG-30	MAX. 35 W	aluminium + PC, aluminio + PC, Aluminium + PC, aluminij + PC,	noir, negro, schwarz, crna	440 g	5902801337383



FR Plafonnier  
ES Luminaria de techo  
DE Deckenleuchte  
HR Stropno rasvjetno tijelo

## LENTO

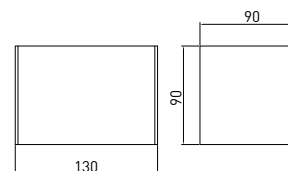

OS-LEN100KKG-30	MAX. 35 W	aluminium + PC, aluminio + PC, Aluminium + PC, aluminij + PC,	noir, negro, schwarz, crna	500 g	5902801337499



FR Plafonnier  
ES Luminaria de techo  
DE Deckenleuchte  
HR Stropno rasvjetno tijelo

RIVEN

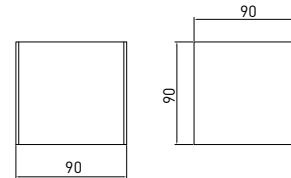

OS-RIV102KKG-30	MAX 35 W	aluminium + PC, aluminio + PC, Aluminium + PC, aluminij + PC,	noir, negro, schwarz, crna	380 g	5902801337468



FR Plafonnier  
ES Luminaria de techo  
DE Deckenleuchte  
HR Stropno rasvjetno tijelo

RIVEN

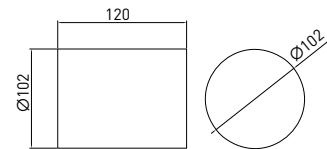

OS-RIV102OKG-30	MAX 35 W	aluminium + PC, aluminio + PC, Aluminium + PC, aluminij + PC,	noir, negro, schwarz, crna	400 g	5902801337451



Dekorative fassungen



FR Luminaire de facade  
ES Luminaria para fachada  
DE Fassadenleuchte  
HR Zidna svjetiljka

VALLA

LED  
EcoMood



8-12 W

3 years warranty

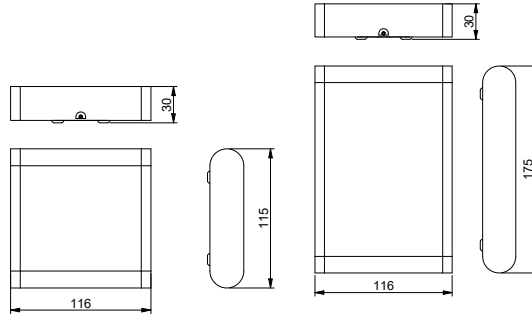

LD-VALLA8W-40

LD-VALLA12W-40



LD-VALLA8W-40	8 W	aluminium + Verre, aluminio + vidrio, Aluminium + Glas, aluminij + staklo	noir, negro, schwarz, crna	359 g	5902801205613
LD-VALLA12W-40	12 W			555 g	5902801203299



Dekorative fassungen



FR Luminaire de facade  
ES Luminaria para fachada  
DE Fassadenleuchte  
HR Zidna svjetiljka

## MISSOURI



Grey

Black

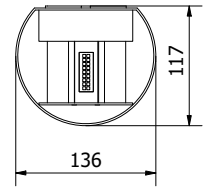
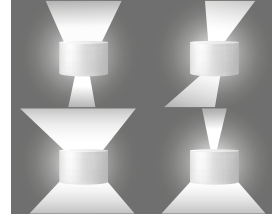

LD-MISS7WOC-NB	7 W	540 lm	aluminium, aluminio, Aluminium, aluminij	noir, negro, schwarz, crna	600 g	5902801239434
LD-MISS7WOS-NB				gris, gris, grau, sivi		5902801316821



FR Luminaire de facade  
ES Luminaria para fachada  
DE Fassadenleuchte  
HR Zidna svjetiljka

## MISSOURI



Grey

Black

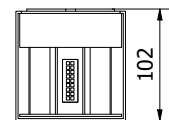
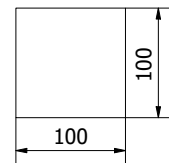
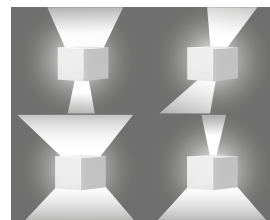

LD-MISS7WKC-NB	7 W	540 lm	aluminium, aluminio, Aluminium, aluminij	noir, negro, schwarz, crna	600 g	5902801239441
LD-MISS7WKS-NB				gris, gris, grau, sivi		5902801316807

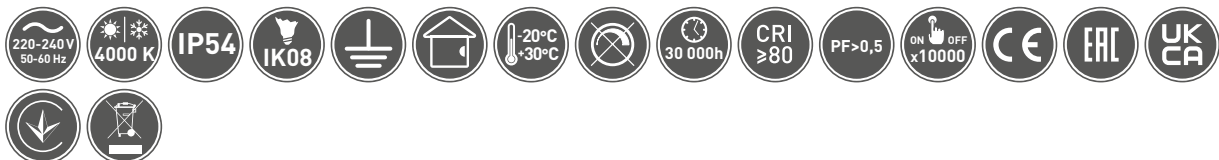

Dekorative fassungen





FR Luminaire de facade  
ES Luminaria para fachada  
DE Fassadenleuchte  
HR Zidna svjetiljka



## CANTI

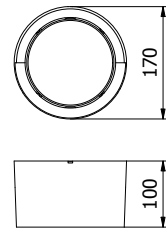
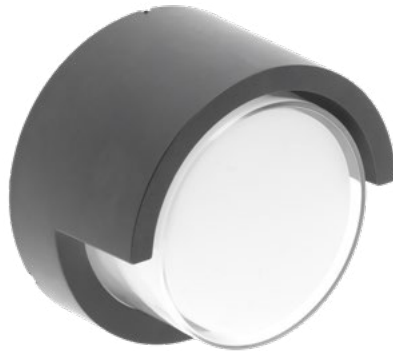

Dekorative fassungen



LD-CANTI12WOK-40	12 W	1000 lm	PC	noir, negro, schwarz, crna	510 g	5902801319648						

FR Luminaire de facade  
ES Luminaria para fachada  
DE Fassadenleuchte  
HR Zidna svjetiljka



## CANTI

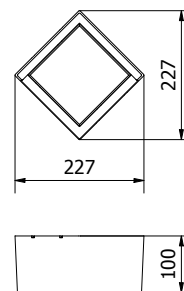

LD-CANTI12WKW-40	12 W	1000 lm	PC	noir, negro, schwarz, crna	600 g	5902801320583						



FR Luminaire de facade  
ES Luminaria para fachada  
DE Fassadenleuchte  
HR Zidna svjetiljka

## PARIS



White

Black

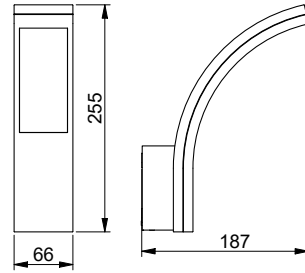

LED

inside

10 W

3 years warranty



LD-PAR10W40BC-00	10 W	PC	blanc, blanco, weiß, bijeli	450 g	5902801234262
LD-PAR10W40BC-10			noir, negro, schwarz, crna		5902801226106

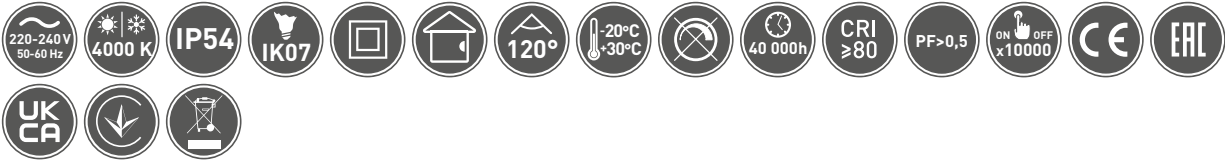

Dekorative fassungen



FR Luminaire de facade  
ES Luminaria para fachada  
DE Fassadenleuchte  
HR Zidna svjetiljka

## PARIS



White

Black

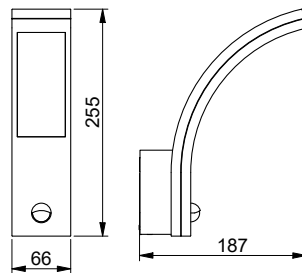

LED

inside

10 W

motion sensor

3 years warranty



LD-PAR10W40-00	10 W	PC	blanc, blanco, weiß, bijeli	450 g	5902801282065
LD-PAR10W40-10			noir, negro, schwarz, crna		5902801282072

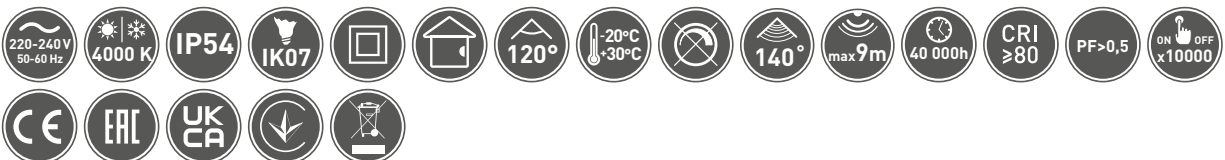







FR Luminaire de facade  
ES Luminaria para fachada  
DE Fassadenleuchte  
HR Zidna svjetiljka



## NESSA



Grey

Black

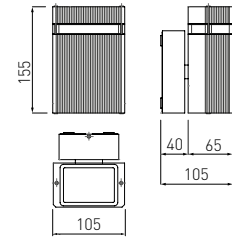

INFO



LD-NESSAGU10J-80	max 50 W	aluminium + Verre trempé, aluminio + vidrio templado, Aluminium + Gehartetes Glas, aluminij + kaljeno staklo	gris, gris, grau, sivi	Unidirectionnel, Unidireccional, unidirekional, jednosmjerna	850 g	5901867122230
LD-NESSAGU10J-20			noir, negro, schwarz, crna			5901867122254



Dekorative fassungen



FR Luminaire de facade  
ES Luminaria para fachada  
DE Fassadenleuchte  
HR Zidna svjetiljka



## NESSA



Grey

Black

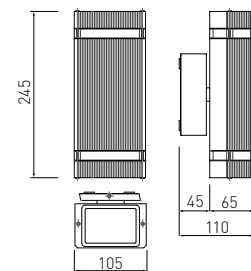

INFO



LD-NESSAGU10D-80	max 2 x 50 W	aluminium + Verre trempé, aluminio + vidrio templado, Aluminium + Gehartetes Glas, aluminij + kaljeno staklo	gris, gris, grau, sivi	À double sens, de doble sentido, bidirekional, dvosmjerna	1100 g	5901867122193
LD-NESSAGU10D-20			noir, negro, schwarz, crna			5901867122216



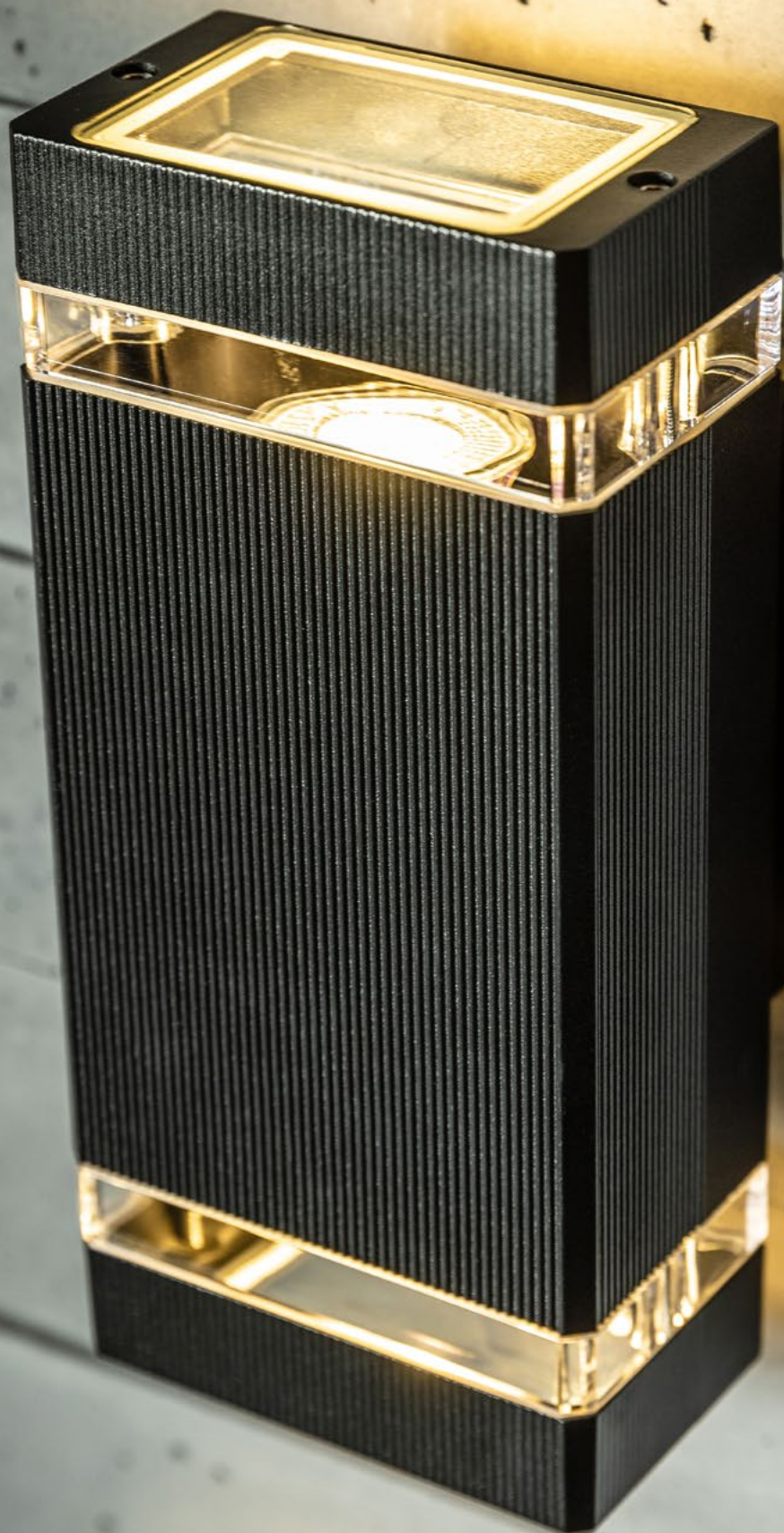

FR Luminaire de facade  
ES Luminaria para fachada  
DE Fassadenleuchte  
HR Zidna svjetiljka



## SILVA



Grey

Black

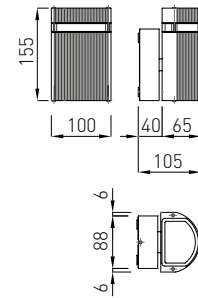

INFO



LD-SILVAGU10J-80	max 50 W	aluminium + Verre trempé, aluminio + vidrio templado, Aluminium + Gehartetes Glas, aluminij + kaljeno staklo	gris, gris, grau, sivi	Unidirectionnel, Unidireccional, unidirekcional, jednosmjerna	800 g	5901867122117
LD-SILVAGU10J-20			noir, negro, schwarz, crna			5901867122131

Dekorative fassungen



FR Luminaire de facade  
ES Luminaria para fachada  
DE Fassadenleuchte  
HR Zidna svjetiljka



## SILVA



Grey

Black

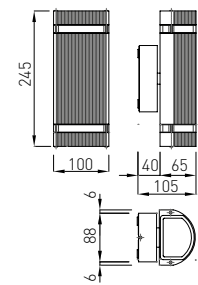

INFO



LD-SILVAGU10D-80	max 2 x 50 W	aluminium + Verre trempé, aluminio + vidrio templado, Aluminium + Gehartetes Glas, aluminij + kaljeno staklo	gris, gris, grau, sivi	À double sens, de doble sentido, bidirekcional, dvosmjerna	1100 g	5901867122155
LD-SILVAGU10D-20			noir, negro, schwarz, crna			5901867122179









FR Luminaire de facade  
ES Luminaria para fachada  
DE Fassadenleuchte  
HR Zidna svjetiljka



## TIAGO



Inox

Black

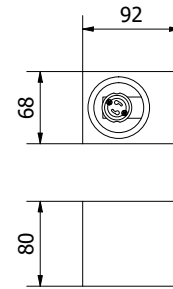

LD-TIAGOGU10J-20KW	max 35 W	aluminium + Verre trempé, aluminio + vidrio templado, Aluminium + Gehartetes Glas, aluminij + kaljeno staklo	noir, negro, schwarz, crna	275 g	5902801211102
LD-TIAGOGU10J-01KW			inox, inox, inox, inox		5902801203305



Dekorative fassungen



FR Luminaire de facade  
ES Luminaria para fachada  
DE Fassadenleuchte  
HR Zidna svjetiljka



## TIAGO



Inox

Black

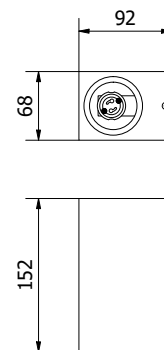

LD-TIAGOGU10D-20KW	2 x max 35 W	aluminium + Verre trempé, aluminio + vidrio templado, Aluminium + Gehartetes Glas, aluminij + kaljeno staklo	noir, negro, schwarz, crna	668 g	5902801212352
LD-TIAGOGU10D-01KW			inox, inox, inox, inox		5902801203329









FR Luminaire de facade  
ES Luminaria para fachada  
DE Fassadenleuchte  
HR Zidna svjetiljka



## TIAGO



Black

Inox

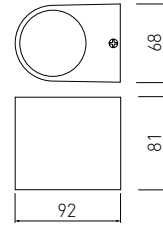

				INFO		
LD-TIAGOGU10J-20	1 x max 35 W	aluminium + Verre trempé, aluminio + vidrio templado, Aluminium + Gehartetes Glas, aluminij + kaljeno staklo	noir, negro, schwarz, crna	Unidirectionnel, Unidireccional, unidireccional, jednosmjerna	300 g	5901867162144
LD-TIAGOGU10J-01			inox, inox, inox, inox			5902801255984



Dekorative fassungen



FR Luminaire de facade  
ES Luminaria para fachada  
DE Fassadenleuchte  
HR Zidna svjetiljka



## TIAGO



Black

Inox

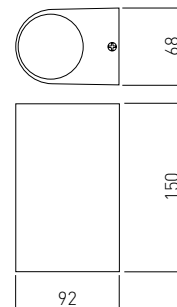

				INFO		
LD-TIAGOGU10D-20	2 x max 35 W	aluminium + Verre trempé, aluminio + vidrio templado, Aluminium + Gehartetes Glas, aluminij + kaljeno staklo	noir, negro, schwarz, crna	À double sens, de doble sentido, bidireccional, dvosmjerna	470 g	5901867162151
LD-TIAGOGU10D-01			inox, inox, inox, inox			5902801256042



FR Luminaire de facade  
ES Luminaria para fachada  
DE Fassadenleuchte  
HR Zidna svjetiljka

## BALEO



LD-BALE27-00



LD-BALGU10-0S

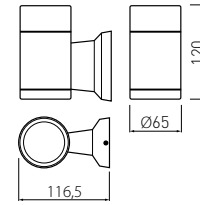

LD-BALGU10-0S

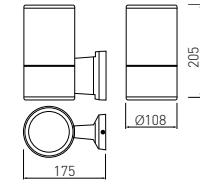

LD-BALE27-00



INFO



LD-BALGU10-0S	1 x max 10 W	GU10	aluminium + Verre trempé, aluminio + vidrio templado, Aluminium + Gehartetes Glas, aluminij + kaljeno staklo	gris, gris, grau, sivi	Unidirectionnel, Unidireccional, unidirekcional, jednosmjerna	300 g	5901867136879
LD-BALE27-00	1 x max 40 W	E27				600 g	5901867136916



FR Luminaire de facade  
ES Luminaria para fachada  
DE Fassadenleuchte  
HR Zidna svjetiljka

## BALEO



LD-BA2E27-00



LD-BA2GU10-0M

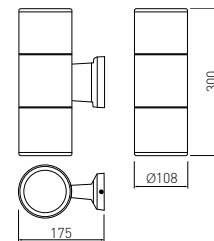

LD-BA2E27-00

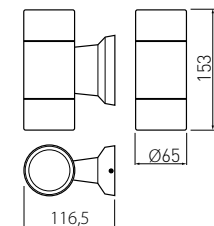

LD-BA2GU10-0M



INFO



LD-BA2E27-00	2 x max 40 W	E27	aluminium + Verre trempé, aluminio + vidrio templado, Aluminium + Gehartetes Glas, aluminij + kaljeno staklo	gris, gris, grau, sivi	À double sens, de doble sentido, bidirekcional, dvosmjerna	900 g	5901867136930
LD-BA2GU10-0M	2 x max 10 W	GU10				400 g	5901867136893





FR Guirlande de jardin  
ES Guirlanda de jardín  
DE Girlande  
HR Vrtna girlanda

**GIRLANDA**

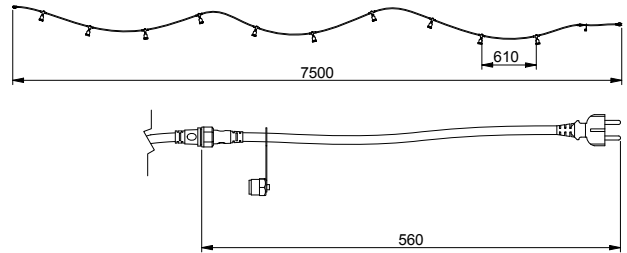
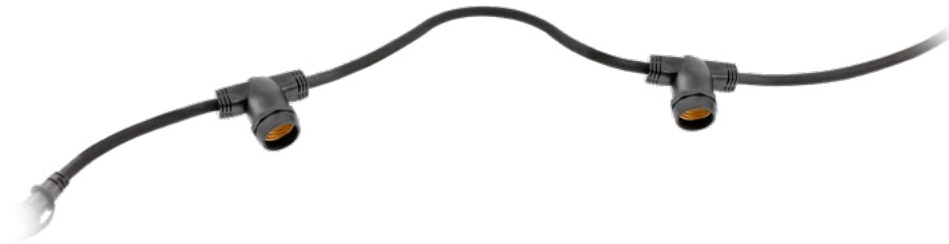
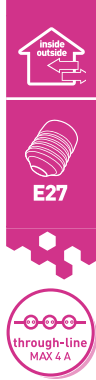

Dekorative fassungen

AE-GR610-10	max. 10 x 10 W	max 15	Plastique, plastico, Kunststoff, plastika	noir, negro, schwarz, crna	1812 g	5902801281242





FR Guirlande de jardin  
ES Guirlanda de jardín  
DE Girlande  
HR Vrtna girlanda

**GIRLANDA**

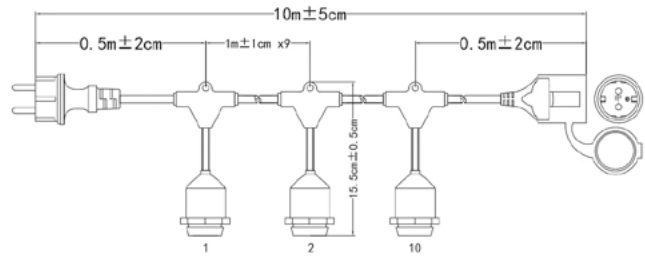

AE-GIR10-10	max. 10 x 10 W	max 15	Plastique, plastico, Kunststoff, plastika	noir, negro, schwarz, crna	1360 g	5902801337017



Dekorative fassungen





## DIEGO

360°



Black

Grey

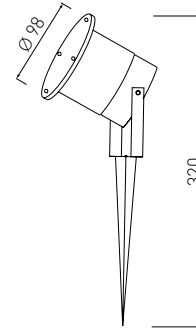

OS-DIEGOGU10-20	max 35 W	aluminium, aluminio, Aluminium, aluminij	noir, negro, schwarz, crna	330 g	5901867185716
OS-DIEGOGU10-80			gris, gris, grau, sivi		5902801256493







FR Luminaire de jardin  
 ES Luminaria para jardín  
 DE Gartenleuchte  
 HR Vrtna svjetiljka

## MARMO

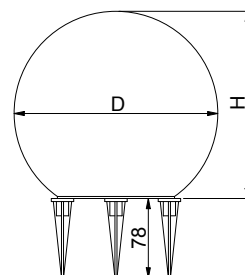

DxH  
mm



			DxH mm		
OS-MARMO25-00	max 35 W	PE	ø250 x 230	812 g	5902801211294
OS-MARMO28-00			ø280 x 250	950 g	5902801224706
OS-MARMO38-00			ø380 x 350	1700 g	5902801224683



Dekorative fassungen





FR Luminaire de jardin  
 ES Luminaria para jardín  
 DE Gartenleuchte  
 HR Vrtna svjetiljka

**GRAZIE**



Black

Inox

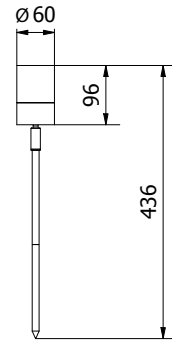

Dekorative fassungen

OS-GRAZIEGU10-20	max 20 W	aluminium, aluminio, Aluminium, aluminij	noir, negro, schwarz, crna	5902801335181
OS-GRAZIEGU10-01			inox, inox, inox, inox	5902801335419



FR Luminaire de sol  
ES Luminaria de suelo  
DE Garten-Bodenleuchte  
HR Nagazna svjetiljka

## ALFA



ON-ALFAOGU10-06



ON-ALFAKGU10-06

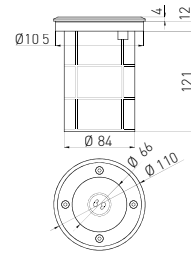

ON-ALFAOGU10-06

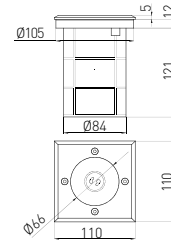

ON-ALFAKGU10-06



ON-ALFAOGU10-06	max 50 W	anneau – acier inoxydable, boîtier – en plastique, corps en aluminium, lamelle; anillo – acero inoxidable, viviendas – plástico, cuerpo de aluminio, cubierta de cristal; Ring – Edelstahl, Gehäuse – Aluminium, Montagebox – PC; okvir – nehrđajući čelik; kućište – aluminij; montažna kutija – PC	500 g	5901867109934
ON-ALFAKGU10-06			700 g	5901867109958



FR Luminaire de plancher intégré  
ES Luminaria de suelo empotrable  
DE Fußbodeneinbauleuchte  
HR Nagazna svjetiljka

## ALFA MINI



ON-ALFAOGU10-06-MINI



ON-ALFAKGU10-06-MINI

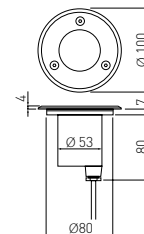

ON-ALFAOGU10-06-MINI

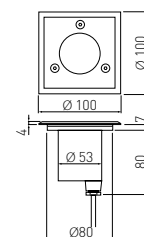

ON-ALFAKGU10-06-MINI



ON-ALFAOGU10-06-MINI	max 10 W	anneau – acier inoxydable; boîtier – aluminium, anillo – acero inoxidable; carcasa – aluminio, Ring – rostfreier Stahl; Gehäuse – Aluminium, prsten – nehrđajući čelik; kućište – aluminij	370 g	5901867119889
ON-ALFAKGU10-06-MINI				5901867119896



FR Luminaire de sol  
ES Luminaria de suelo  
DE Garten-Bodenleuchte  
HR Nagazna svjetiljka

**BETA**



ON-BETAOGU10RK-06



ON-BETAKGU10RK-06

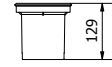
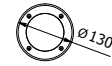

ON-BETAOGU10RK-06

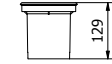
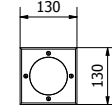

ON-BETAKGU10RK-06

Dekorative fassungen



ON-BETAOGU10RK-06	max 50 W	anneau – acier inoxydable, boîtier – en plastique, corps en aluminium, lamelle; anillo – acero inoxidable, viviendas – plástico, cuerpo de aluminio, cubierta de cristal; Ring – Edelstahl, Gehäuse – Aluminium, Montagebox – PC; okvir – nehrđajući čelik; kućište – aluminij; montažna kutija – PC	1070 g	5902801335341
ON-BETAKGU10RK-06			1210 g	5902801335488



FR Couvercle unidirectionnel et bidirectionnel pour luminaires incorporés dans le sol  
ES Señalizador luminoso unidireccional/bidireccional de vías  
DE Uni- und Bidirektionale Abdeckung für Einfahrtlampe  
HR Jednosmjerni i dvosmjerni difuzor na nagaznu svjetiljku

**ALFA-O**



ON-ALFAO-C1W



ON-ALFAO-C2W



INFO



ON-ALFAO-C1W	ON-ALFAOGU10-06	Couvercle unidirectionnel de diffuseur, cubierta unidireccional del difusor, Unidirektionale Abdeckung, jednosmjerno kućište (poklopac) difuzora	acier Inox, acero inoxidable, rostfreier Stahl, nehrđajući čelik	5901867122360
ON-ALFAO-C2W	ON-ALFAKGU10-06	Couvercle bidirectionnel de diffuseur, cubierta bidireccional del difusor, bidirektionale Abdeckung, dvosmjerno kućište (poklopac) difuzora		5901867122384









LAMPES DE BUREAU  
LÁMPARAS DE ESCRITORIO  
SCHREIBTISCHLAMPEN  
STOLNE SVJETILJKE

FR Lampe de bureau LED  
ES Lámpara de escritorio LED  
DE LED-Schreibtischleuchte  
HR LED stolna svjetiljka

## GALACTIC LED

360°

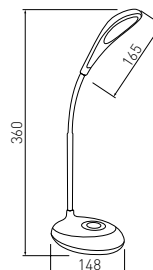

LED  
technology



DIMMABLE



RGB



LB-GAL3WRU-10	3 W	120 lm	● 4000 K	Plastique, plastico, Kunststoff, plastika	blanc, blanco, weiß, bijeli	314 g	5902801010392
---------------	-----	--------	----------	---	-----------------------------	-------	---------------



FR Lampe de bureau LED  
ES Lámpara de escritorio LED  
DE LED-Schreibtischleuchte  
HR LED stolna svjetiljka

## GALACTIC LED

360°

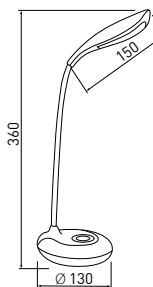

LED  
technology



DIMMABLE



RGB



LB-GAL5WRU-10	5 W	240 lm	● 4000 K	Plastique, plastico, Kunststoff, plastika	blanc, blanco, weiß, bijeli	554 g	5902801010408
---------------	-----	--------	----------	---	-----------------------------	-------	---------------



Dekorative fassungen





FR Lampe de bureau LED  
ES Lámpara de escritorio LED  
DE LED-Schreibtischleuchte  
HR LED stolna svjetiljka

## HALLEY



White  
Black

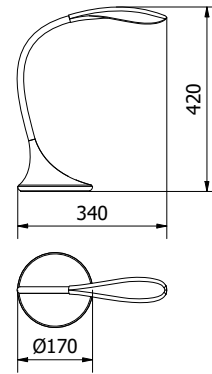

Dekorative fassungen



LB-HAL8W-00-DEC	8 W	500 lm	● 4000 K	Plastique, plastique, Kunststoff, plastika	blanc, blanco, weiß, bijeli	1660 g	5902801345432
LB-HAL8W-10-DEC					noir, negro, schwarz, crna		5902801345487



FR Lampe de bureau LED  
ES Lámpara de escritorio LED  
DE LED-Schreibtischleuchte  
HR LED stolna svjetiljka

## FROGY

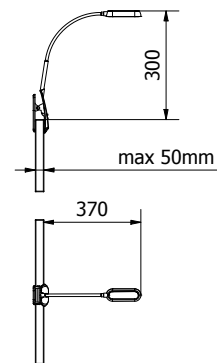

LB-FRO5W-00-DEC	5 W	300 lm	● 4000 K	ABS	blanc, blanco, weiß, bijeli	520 g	5902801301650





FR Lampe de bureau LED  
ES Lámpara de escritorio LED  
DE LED-Schreibtischleuchte  
HR LED stolna svjetiljka



## FLOWER

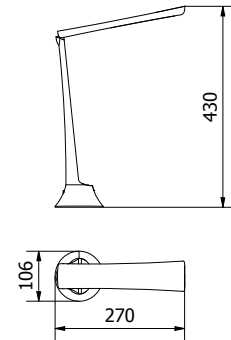

Dekorative fassungen

LB-FLOW4W-06-DEC	4 W	240 lm	4000 K	ABS	blanc/noir, blanco/negro, weiß/schwarz, bijeli/crna	740 g	5902801301261



FR Lampe de bureau LED  
ES Lámpara de escritorio LED  
DE LED-Schreibtischleuchte  
HR LED stolna svjetiljka

## HIKARI



White

Black

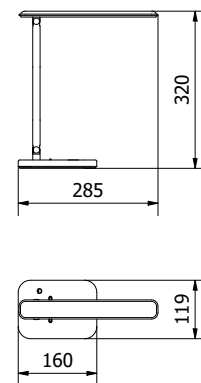

LB-HIK6WCCT-00	6 W	400 lm	PC	blanc, blanco, weiß, bijeli	520 g	5902801228360
LB-HIK6WCCT-10				noir, negro, schwarz, crna		5902801228100

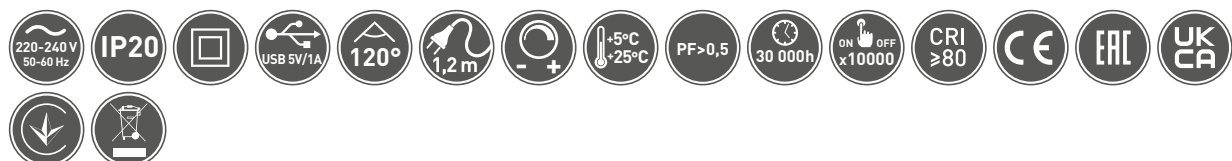



FR Lampe de bureau LED  
ES Lámpara de escritorio LED  
DE LED-Schreibtischleuchte  
HR LED stolna svjetiljka

# IZUKA

360°



White

Black

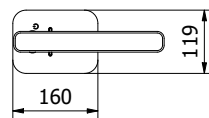
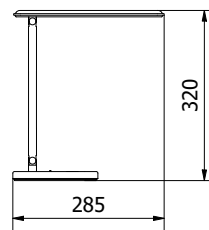

LB-IZK6WCCT-00	6 W	400 lm	PC	blanc, blanco, weiß, bijeli	520 g	5902801226960
LB-IZK6WCCT-10				noir, negro, schwarz, crna		5902801226120

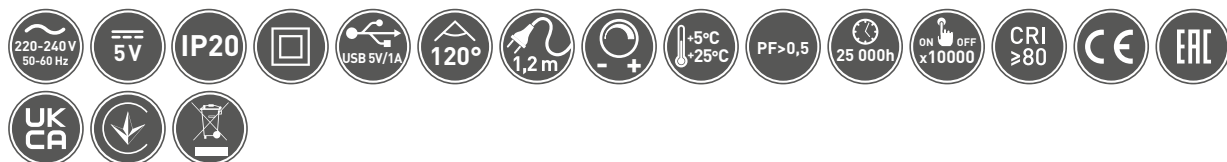

Dekorative fassungen



FR Lampe de bureau LED  
 ES Lámpara de escritorio LED  
 DE LED-Schreibtischleuchte  
 HR LED stolna svjetiljka



## GALACTIC LED



Dekorative fassungen

LB-GAL5WMO-10	5 W	240 lm	Plastique, plastico, Kunststoff, plastika	blanc, blanco, weiß, bijeli	732 g	5902801010514



FR Lampe de bureau LED  
 ES Lámpara de escritorio LED  
 DE LED-Schreibtischleuchte  
 HR LED stolna svjetiljka

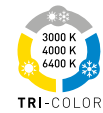

## LINEAR



White

Black

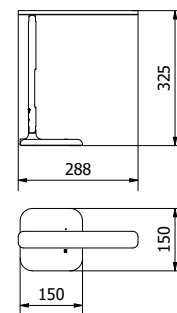

LB-LIN7W-00-DEC	7 W	420 lm	2700 K	ABS	blanc, blanco, weiß, bijeli	750 g	5902801345524
LB-LIN7W-10-DEC			4500 K		noir, negro, schwarz, crna		5902801346064
			6500 K				







FR Lampe de bureau LED  
 ES Lámpara de escritorio LED  
 DE LED-Schreibtischleuchte  
 HR LED stolna svjetiljka

**GALE**



White

Black

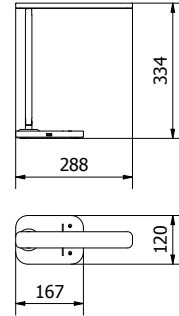

Dekorative fassungen

LB-GAL8W-00-DEC	8 W	550 lm	● 4000 K	ABS	blanc, blanco, weiß, bijeli	785 g	5902801346125
LB-GAL8W-10-DEC					noir, negro, schwarz, crna		5902801346156



# TRITTON



White

Black

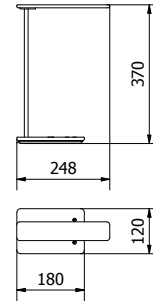

FOUR-COLOR



LB-TRIT6W-00-DEC	6 W	340 lm	● 2700 K	aluminium + ABS, aluminio + ABS, Aluminij + ABS,	blanc, blanco, weiß, bijeli	800 g	5902801346484
LB-TRIT6W-10-DEC			● 3000 K				● 4000 K



FR Lampe de bureau LED  
ES Lámpara de escritorio LED  
DE LED-Schreibtischleuchte  
HR LED stolna svjetiljka

## BRESSI



Gold  
Balck

Grey

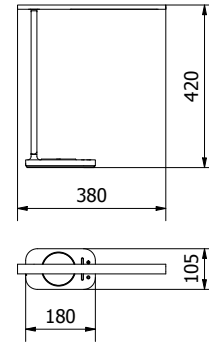

LED  
LEDNOLICA



Dekorative fassungen

LB-BRE8W-11-DEC	8 W	450 lm	<ul style="list-style-type: none"> <li><span style="color: orange;">●</span> 3000 K</li> <li><span style="color: grey;">●</span> 4000 K</li> <li><span style="color: blue;">●</span> 6400 K</li> </ul>	aluminium + ABS, aluminio + ABS, Aluminium + ABS, aluminij + ABS	noir/doré, negro/oro, schwarz/gold, crna/zlatnim	750 g	5902801346736
LB-BRE8W-15-DEC							gris, gris, grau, sivi



FR Lampe de bureau LED  
ES Lámpara de escritorio LED  
DE LED-Schreibtischleuchte  
HR LED stolna svjetiljka

## HELIN



Blue

Pink

Grey

White

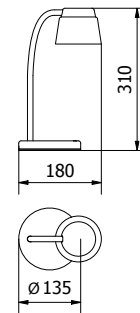

LED  
LEDNOLICA



LB-HEL6W-25-DEC	6 W	350 lm	● 4000 K	ABS	bleu, azul, blau, plava	800 g	5902801346507	
LB-HEL6W-20-DEC							rose, rosa, pink, ružičasta	5902801346651
LB-HEL6W-15-DEC							gris, gris, grau, sivi	5902801308505
LB-HEL6W-00-DEC							blanc, blanco, weiß, bijeli	5902801346699







FR Lampe de bureau LED  
ES Lámpara de escritorio LED  
DE LED-Schreibtischleuchte  
HR LED stolna svjetiljka

## LONEOS

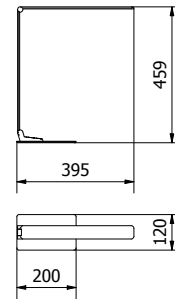

LED  
TECHNOLOGY

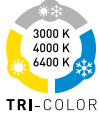

Dekorative fassungen

LB-LON12W-10-DEC	12 W	700 lm	<ul style="list-style-type: none"> <li><span style="color: orange;">●</span> 3000 K</li> <li><span style="color: grey;">●</span> 4000 K</li> <li><span style="color: blue;">●</span> 6000 K</li> </ul>	ABS	noir, negro, schwarz, crna	875 g	5902801346323



FR Lampe de bureau LED  
ES Lámpara de escritorio LED  
DE LED-Schreibtischleuchte  
HR LED stolna svjetiljka

**NEW**

LED  
TECHNOLOGY



## MONUM



LB-MON3W-02-DEC



LB-MON3W-40-DEC



LB-MON3W-41-DEC

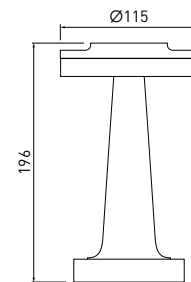

LB-MON3W-40-DEC	3 W	200 lm	<span style="color: orange;">●</span> 3000 K	aluminium, aluminio, Aluminium, aluminij	or brossé, oro cepillado, gebürstetes Gold, brušeno zlato	400 g	5902801379253
LB-MON3W-02-DEC					acier Inox, acero inoxidable, rostfreier Stahl, nehrđajuci čelik		5902801379260
LB-MON3W-41-DEC					cuivre brossé, cobre cepillado, gebürsteter Böttcher, brušeni bakar		5902801379345



FR Lampe de bureau LED  
ES Lámpara de escritorio LED  
DE LED-Schreibtischleuchte  
HR LED stolna svjetiljka

## ARCHITECTO



White

Black

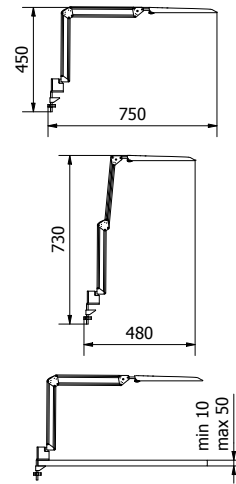

LB-ARCH8W-00	8 W	600 lm	● 4000 K	ABS	blanc, blanco, weiß, bijeli	650 g	5902801357749
LB-ARCH8W-10					noir, negro, schwarz, crna		5902801357756

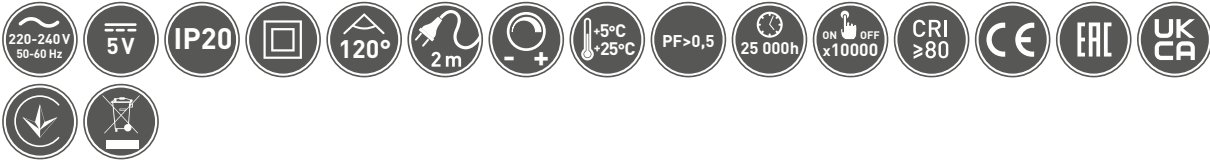

FR Lampe de bureau LED  
ES Lámpara de escritorio LED  
DE LED-Schreibtischleuchte  
HR LED stolna svjetiljka

## VENETO



White

Black

NEW



LB-VEN20WO-00	max 20 W	aluminium, aluminio, Aluminium, aluminij	blanc, blanco, weiß, bijeli	825 g	5902801442568
LB-VEN20W-10			noir, negro, schwarz, crna		5902801403392





FR Lampadaire  
ES Lámpara de suelo  
DE Fußbodenleuchte  
HR Podna svjetiljka

# VASALIA



Dekorative fassungen

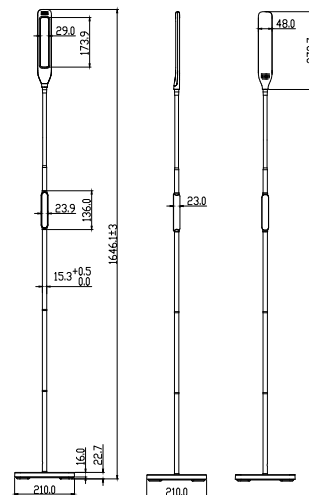

LP-VAS8W-10-DEC	8 W	450 lm	<ul style="list-style-type: none"> <li><span style="color: orange;">●</span> 2700 K</li> <li><span style="color: grey;">●</span> 4500 K</li> <li><span style="color: blue;">●</span> 6500 K</li> </ul>	ABS	noir, negro, schwarz, crna	2250 g	5902801346774
-----------------	-----	--------	--	-----	----------------------------	--------	---------------







**YORK**



Dekorative fassungen



White

Black

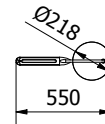
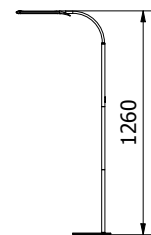

LP-YORK10W-00-DEC	10 W	900 lm	<ul style="list-style-type: none"> <li><span style="color: orange;">●</span> 3000 K</li> <li><span style="color: grey;">●</span> 4500 K</li> <li><span style="color: blue;">●</span> 6000 K</li> </ul>	<ul style="list-style-type: none"> <li>ABS +Metall,</li> <li>ABS +Metall,</li> <li>ABS +Metall,</li> <li>ABS + metalni</li> </ul>	<ul style="list-style-type: none"> <li>blanc, blanco, weiß, bijeli</li> <li>noir, negro, schwarz, crna</li> </ul>	2670 g	5902801301551
LP-YORK10W-10-DEC			5902801301834				







FR Lampadaire  
ES Lámpara de suelo  
DE Fußbodenleuchte  
HR Podna svjetiljka

## BENFICA 2



Dekorative fassungen

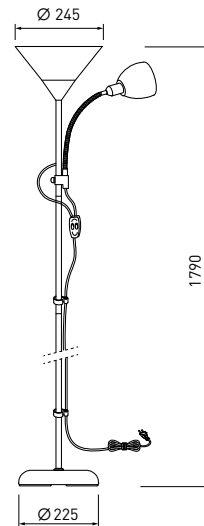

LP-BENFICA2-10	E27 - max 60 W E14 - max 40 W	Metall + plastique, Metall + plástico, Metall + Kunststoff, metalni + plastika	noir, negro, schwarz, crna	3000 g	5902801297809
LP-BENFICA2-80			gris, gris, grau, sivi		5908231398123
LP-BENFICA2-00			blanc, blanco, weiß, bijeli		5902801298233



FR Lampadaire  
ES Lámpara de suelo  
DE Fußbodenleuchte  
HR Podna svjetiljka

## VENETO



White

Black

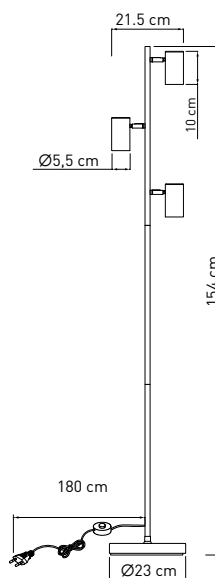

Dekorative fassungen

LP-VEN20WO-00	3 x max 20 W	Metall + plastique, Metall + plástico, Metall + Kunststoff, metalni + plastika	blanc, blanco, weiß, bijeli	3744 g	5902801442971
LP-VEN20W-10			noir, negro, schwarz, crna		5902801403491









SYSTÈME TRACK  
SISTEMAS DE CARRIL  
SCHIENENSYSYEME  
ŠINSKI SUSTAVI



Systèmes de rail monophasés  
Sistemas ferroviarios monofásicos  
1-Phasen-SchienensystemeReflektori LED  
1-fazni tračnički sustaviBodové svetlá LED ..... 317

Spot LED  
Proyectores LED  
Spotlights LED  
Reflektori LED ..... 318

Accessoires  
Accesorios  
Zubehör  
Pribor..... 322

Jeux de barres  
Barras colectoras  
Stromschienen  
Sabirnice..... 322

Systèmes de rail triphasés  
Sistemas ferroviarios trifásicos  
3-Phasen-Schienensysteme  
3-fazni tračnički sustavi ..... 325

Spot LED  
Proyectores LED  
Spotlights LED  
Reflektori LED ..... 326

Jeux de barres  
Barras colectoras  
Stromschienen  
Sabirnice..... 338

Accessoires  
Accesorios  
Zubehör  
Pribor..... 345





SYSTÈMES DE RAIL MONOPHASÉS  
SISTEMAS FERROVIARIOS MONOFÁSICOS  
1-PHASEN-SCHIENENSYSYSTEMEREFLEKTORI LED  
1-FAZNI TRAČNIČKI SUSTAVIBODOVÉ SVETLÁ LED

FR Réflecteur pour barre omnibus monophasée  
 ES Reflector para barra colectora monofásica  
 DE 1-Phasen-Stromschienenstrahler  
 HR Reflektor za 1-faznu sabirnicu

**ORIO**



White

Black

**NEW**



XLT-ORI-GU10-00	max 20 W	blanc, blanco, weiß, bijeli	aluminium, aluminium, алюминий, алюміній	230 g	5902801391217
XLT-ORI-GU10-10		noir, negro, schwarz, crna			5902801391231



Track systems



FR Ensemble de luminaires  
 ES Conjunto de focos  
 DE Leuchtenset  
 HR Set svjetiljki

**TRAX BIS**



White

Black

**NEW**

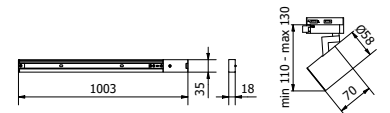

XLT-Z3OP20SZ1B-10	max 20 W	noir, negro, schwarz, crna	aluminium, aluminium, алюминий, алюміній	1280 g	5902801345340
XLT-Z3OP20SZ1B-00		blanc, blanco, weiß, bijeli			5902801345357



FR Réflecteur pour barre omnibus monophasée  
 ES Reflector para barra colectora monofásica  
 DE 1-Phasen-Stromschienenstrahler  
 HR Reflektor za 1-faznu sabirnicu

**ADO**



White

Black

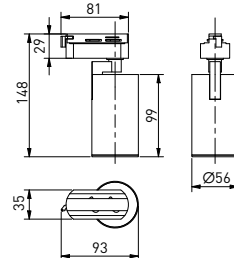

XLT-ADOGU10-00	max 20 W	blanc, blanco, weiß, bijeli	aluminium, aluminium, алюминий, алюміній	230 g	5902801336508
XLT-ADOGU10-10		noir, negro, schwarz, crna			5902801336348



FR Réflecteur pour barre omnibus monophasée  
 ES Reflector para barra colectora monofásica  
 DE 1-Phasen-Stromschienenstrahler  
 HR Reflektor za 1-faznu sabirnicu

**ETNA**



White

Black

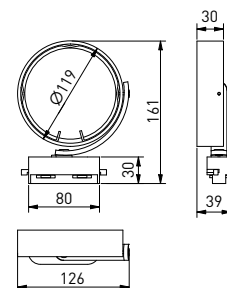

XLT-ETNAES111-00	max 20 W	blanc, blanco, weiß, bijeli	aluminium, aluminium, алюминий, алюміній	230 g	5902801336409
XLT-ETNAES111-10		noir, negro, schwarz, crna			5902801336577





FR Spot LED sur rail  
ES Faro para barra colectora  
DE Schienen-Scheinwerfer  
HR Reflektor sabirnice

LIMA

**NEW**

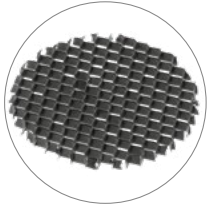

White

Black

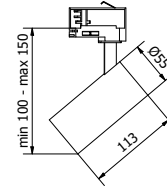

XLT-LMAGU10KB-NB	max 20 W	blanc, blanco, weiß, bijeli	aluminium, aluminium, алюминий, алюміній	290 g	5902801383144
XLT-LMAGU10KC-NB		noir, negro, schwarz, crna			5902801383182



FR Réflecteur pour barre omnibus monophasée  
ES Reflector para barra colectora monofásica  
DE 1-Phasen-Stromschienenstrahler  
HR Reflektor za 1-faznu sabirnicu

LIMA

**NEW**

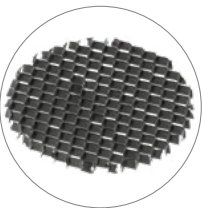

White

Black

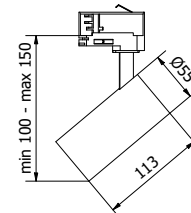

XLT-LMAGU10OB-NB	max 20 W	blanc, blanco, weiß, bijeli	aluminium, aluminium, алюминий, алюміній	230 g	5902801382765
XLT-LMAGU10OC-NB		noir, negro, schwarz, crna			5902801383106



FR Réflecteur pour barre omnibus monophasée  
 ES Reflector para barra colectora monofásica  
 DE 1-Phasen-Stromschienenstrahler  
 HR Reflektor za 1-faznu sabirnicu

**GROSSO**



White

Black

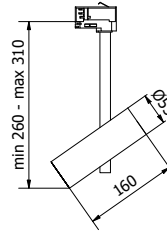

XLT-GRSGU10KB-NB	max 20 W	blanc, blanco, weiß, bijeli	aluminium, aluminium, алюминий, алюміній	380 g	5902801383212
XLT-GRSGU10KC-NB		noir, negro, schwarz, crna			5902801383236

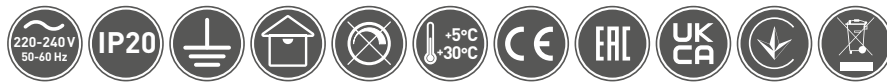

FR Réflecteur pour barre omnibus monophasée  
 ES Reflector para barra colectora monofásica  
 DE 1-Phasen-Stromschienenstrahler  
 HR Reflektor za 1-faznu sabirnicu

**GROSSO**

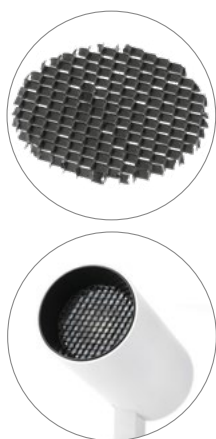

White

Black

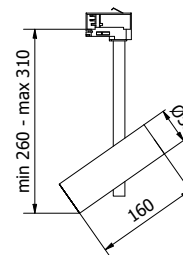

XLT-GRSGU10OB-NB	max 20 W	blanc, blanco, weiß, bijeli	aluminium, aluminium, алюминий, алюміній	450 g	5902801383274
XLT-GRSGU10OC-NB		noir, negro, schwarz, crna			5902801383298

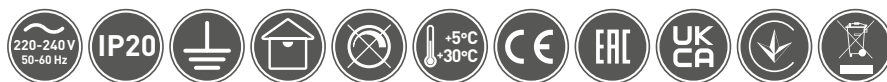

FR Rail monophasé  
ES Carril monofásico  
DE 1-Phasen-Schiene  
HR 1-fazni kolosijek

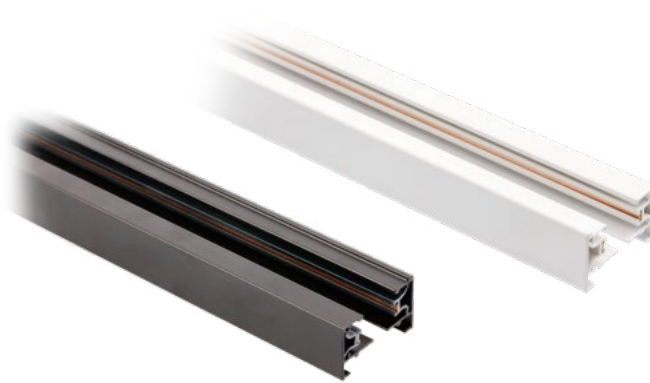

XLT-1FAC67-10	2 m	noir, negro, schwarz, crna	aluminium, aluminium, алюминий, алюміній	700 g	5902801320323
XLT-1FAC21A-10	1 m			350 g	5902801320842
XLT-1FAC66-00	2 m	blanc, blanco, weiß, bijeli		700 g	5902801320569
XLT-1FAC13A-00	1 m			350 g	5902801320828



XLT-1FAC24A-10



XLT-1FAC34-10



XLT-1FAC79-10



XLT-1FAC69-10



XLT-1FAC71-10

XLT-1FAC24A-10	40 g	5902801321498
XLT-1FAC34-10	60 g	5902801321511
XLT-1FAC79-10	60 g	5902801321344
XLT-1FAC69-10	60 g	5902801321337
XLT-1FAC71-10	40 g	5902801321399
XLT-1FAC19-00	40 g	5902801321597
XLT-1FAC33-00	60 g	5902801321481
XLT-1FAC78-00	60 g	5902801321504
XLT-1FAC68-00	60 g	5902801321405
XLT-1FAC70-00	40 g	5902801321375











SYSTÈMES DE RAIL TRIPHASÉS  
SISTEMAS FERROVIARIOS TRIFÁSICOS  
3-PHASEN-SCHIENENSYSYSTEME  
3-FAZNI TRAIČNIČKI SUSTAVI



FR Projecteur pour jeu de barres triphasé  
 ES Reflector para barra colectora trifásica  
 DE 3-Phasen-Stromschienenstrahler  
 HR Reflektor za 3-faznu sabirnicu

LIMA



White

Black

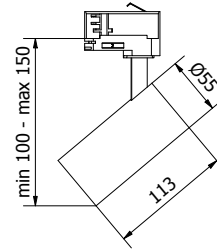

XLD-LMAGU10OB-NB	max 20 W	blanc, blanco, weiß, bijeli	aluminium, aluminium, алюминий, алюміній	230 g	5902801322280
XLD-LMAGU10OC-NB		noir, negro, schwarz, crna			5902801322419



FR Projecteur pour jeu de barres triphasé  
 ES Reflector para barra colectora trifásica  
 DE 3-Phasen-Stromschienenstrahler  
 HR Reflektor za 3-faznu sabirnicu

LIMA



White

Black

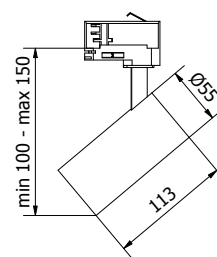

XLD-LMAGU10KB-NB	max 20 W	blanc, blanco, weiß, bijeli	aluminium, aluminium, алюминий, алюміній	340 g	5902801322501
XLD-LMAGU10KC-NB		noir, negro, schwarz, crna			5902801322150





FR Projecteur pour jeu de barres triphasé  
 ES Reflector para barra colectora trifásica  
 DE 3-Phasen-Stromschienenstrahler  
 HR Reflektor za 3-faznu sabirnicu

**GROSSO**

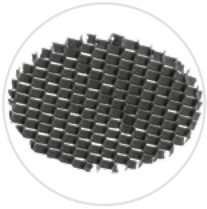

White  
 Black

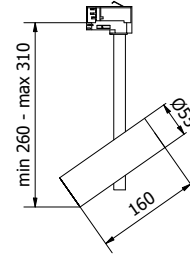

inside  
**GU10**  
 5 years warranty  
 3 PHASE

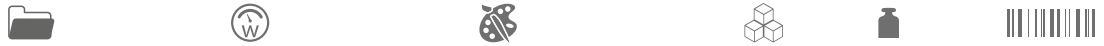

XLD-GRSGU10OB-NB	max 20 W	blanc, blanco, weiß, bijeli	aluminium, aluminium, алюминий, алюміній	430 g	5902801356469
XLD-GRSGU10OC-NB		noir, negro, schwarz, crna			5902801356520

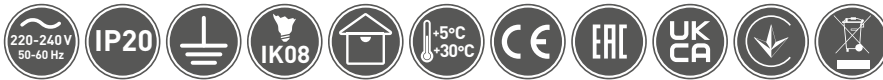

FR Projecteur pour jeu de barres triphasé  
 ES Reflector para barra colectora trifásica  
 DE 3-Phasen-Stromschienenstrahler  
 HR Reflektor za 3-faznu sabirnicu

**GROSSO**

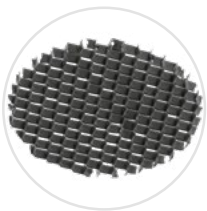

White  
 Black

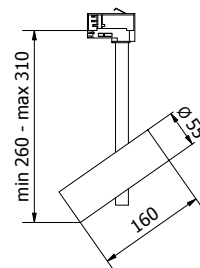

inside  
**GU10**  
 5 years warranty  
 3 PHASE



XLD-GRSGU10KB-NB	max 20 W	blanc, blanco, weiß, bijeli	aluminium, aluminium, алюминий, алюміній	430 g	5902801356452
XLD-GRSGU10KC-NB		noir, negro, schwarz, crna			5902801356483







FR Anneau frontal anti-éblouissement pour spot LED sur rail LIMA et GROSSO  
 ES Extremo de luminaria para barra colectora LIMA y GROSSO  
 DE Endstück für Leuchte auf Lichtschienen LIMA und GROSSE  
 HR Usmjerivači svjetlosti za LIMA i GROSSO reflektore



XLD-LKSWLGAB-00



XLD-LKSWLGBB-00



XLD-LKSWLGCB-00



XLD-LKSWLGAC-00



XLD-LKSWLGBC-00



XLD-LKSWLGCC-00

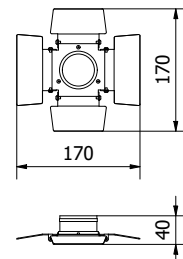
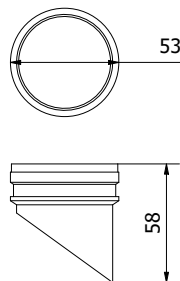
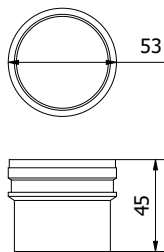

XLD-LKSWLGAB-00	blanc, blanco, weiß, bijeli	aluminium, aluminium, алюминий, алюміній	100 g	5902801357732
XLD-LKSWLGAC-00	noir, negro, schwarz, crna			5902801357800
XLD-LKSWLGBB-00	blanc, blanco, weiß, bijeli			5902801357794
XLD-LKSWLGBC-00	noir, negro, schwarz, crna			5902801357831
XLD-LKSWLGCB-00	blanc, blanco, weiß, bijeli			5902801357848
XLD-LKSWLGCC-00	noir, negro, schwarz, crna			5902801357879





FR Projecteur pour jeu de barres triphasé  
 ES Reflector para barra colectora trifásica  
 DE 3-Phasen-Stromschienenstrahler  
 HR Reflektor za 3-faznu sabirnicu

inside  
**8 W**

**SIERRA**



White

Black

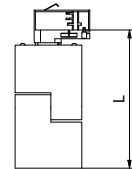
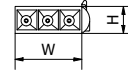

**5**  
years  
warranty

**3**  
PHASE



XLD-SRA08WB-NB	8 W	blanc, blanco, weiß, bijeli	aluminium, aluminium, алюминий, алюміній	174 x 84 x 34	480 g	5902801357473
XLD-SRA08WC-NB		noir, negro, schwarz, crna				5902801357558



FR Projecteur pour jeu de barres triphasé  
 ES Reflector para barra colectora trifásica  
 DE 3-Phasen-Stromschienenstrahler  
 HR Reflektor za 3-faznu sabirnicu

inside  
**18 W**

**SIERRA**



White

Black

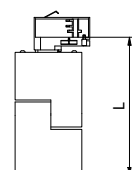
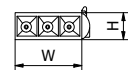

**5**  
years  
warranty

**3**  
PHASE



XLD-SRA18WB-NB	18 W	blanc, blanco, weiß, bijeli	aluminium, aluminium, алюминий, алюміній	177 x 163 x 34	840 g	5902801357596
XLD-SRA18WC-NB		noir, negro, schwarz, crna				5902801357619







FR Projecteur pour jeu de barres triphasé  
 ES Reflector para barra colector trifásica  
 DE 3-Phasen-Stromschienenstrahler  
 HR Reflektor za 3-faznu sabirnicu

# SIERRA



White

Black

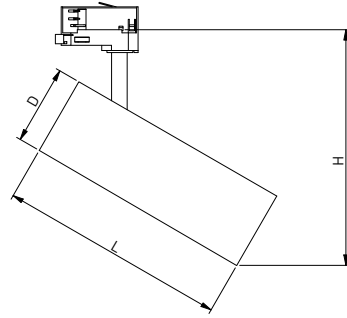

	L	D	H min	H max
TLD-12W38LN-NB0	155	ø55	130	210
TLD-12W38LN-NB1				
TLD-20W38LN-NB0	185	ø66	145	230
TLD-20W38LN-NB1				
TLD-30W38LN-NB0	220	ø77	153	270
TLD-30W38LN-NB1				

Track systems



TLD-12W38LN-NB0	12 W	● 4000 K	PF>0,5	1100 lm	blanc, blanco, weiß, bijeli	aluminium, aluminium, алюминий, алюміній	38°	370 g	5902801278563
TLD-12W38LN-NB1					noir, negro, schwarz, crna				5902801278570
TLD-20W38LN-NB0	20 W		PF>0,9	1800 lm	blanc, blanco, weiß, bijeli			560 g	5902801278495
TLD-20W38LN-NB1					noir, negro, schwarz, crna				5902801278631
TLD-30W38LN-NB0	30 W		2700 lm	blanc, blanco, weiß, bijeli	710 g			5902801278594	
TLD-30W38LN-NB1				noir, negro, schwarz, crna				5902801278617	







35°

30°

25°

20°

15°

- FR Spot LED X-Line
- ES Proyector LED X-Line
- DE Spotlight LED X-Line
- HR Reflektor LED X-Line



White

Black

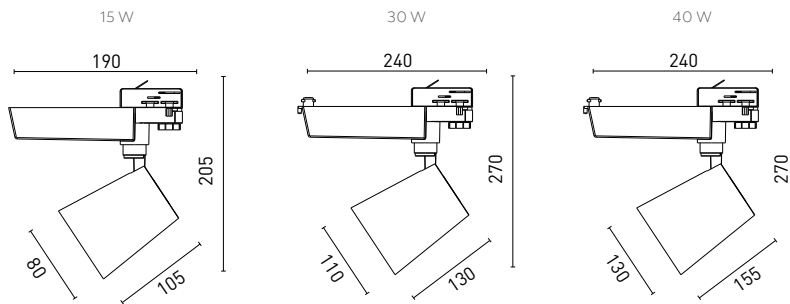

Track systems



XLD-1524XLN-NB0	15 W	● 4000 K	1090 lm	blanc, blanco, weiß, bijeli	24°	0,6 kg	5901867199829
XLD-1560XLN-NB0					60°		5901867199843
XLD-3024XLN-NB0	30 W	● 4000 K	2050 lm	noir, negro, schwarz, crna	24°	1,2 kg	5901867199881
XLD-3024XLN-NB1					60°		5902801000089
XLD-3060XLN-NB1					60°		5902801000102
XLD-3060XLN-NB0	40 W	● 4000 K	3240 lm	blanc, blanco, weiß, bijeli	60°	1,5 kg	5901867199904
XLD-4024XLN-NB0					24°		5901867199942
XLD-4060XLN-NB0					60°		5901867199966











JEUX DE BARRES  
BARRAS COLECTORAS  
STROMSCHIENEN  
SABIRNICE

FR Track 3 Circuits  
ES Carril conductor trifásico  
DE Dreiphasenschiene  
HR Trofazna šina

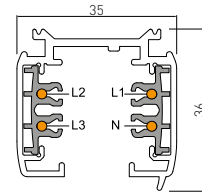

XTR-RA3FZ1B-00	blanc, blanco, weiß, bijeli	1 m	5901867193131
XTR-RA3FZ1C-10	noir, negro, schwarz, crna	1 m	5901867193155
XTR-RA3FZ2B-00	blanc, blanco, weiß, bijeli	2 m	5901867193162
XTR-RA3FZ2C-10	noir, negro, schwarz, crna	2 m	5901867193179



FR Track 3 Circuits  
ES Carril conductor trifásico  
DE Dreiphasenschiene  
HR Trofazna šina

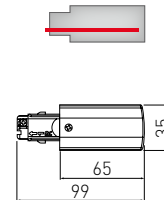

XAE-KZASPB-00	blanc, blanco, weiß, bijeli	5901867193339
XAE-KZASPC-10	noir, negro, schwarz, crna	5901867193322



FR Connecteur 3 circuits - Fin de ligne  
ES Terminal fuente de alimentación  
DE Energieversorgungsanschluss  
HR Konektor za napajanje

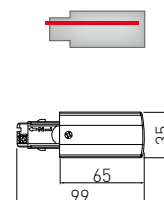
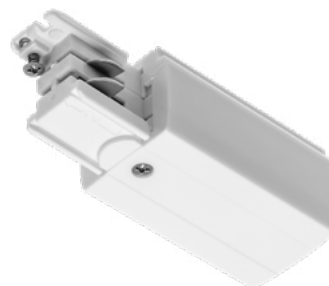

XAE-KZASLB-00	blanc, blanco, weiß, bijeli	5901867193308
XAE-KZASLC-10	noir, negro, schwarz, crna	5901867193315



FR Connecteur 3 circuits en "L" ajustable  
 ES "L" ajustable, regulable  
 DE "L" Verbindungsstück, regulierbar  
 HR L-spojnicica s regulacijom

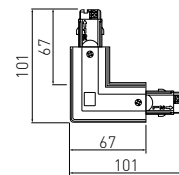
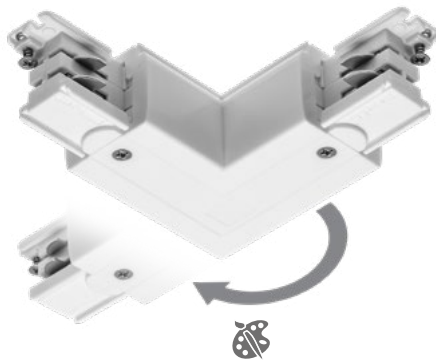

XAE-LKLRZWB-00	blanc, blanco, weiß, bijeli	5901867193544
XAE-LKLRZWC-10	noir, negro, schwarz, crna	5901867193551



FR Connecteur 3 circuits en "L" 90°  
 ES Conector "L"  
 DE "L" Verbindungsstück  
 HR L-spojnicica

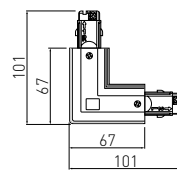
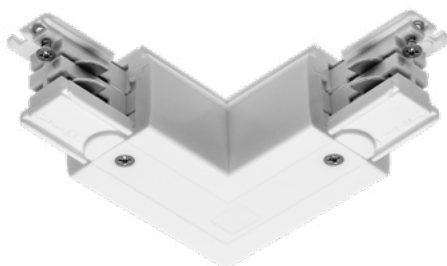

XAE-LKLLZB-00	blanc, blanco, weiß, bijeli	5901867193421
XAE-LKLLZC-10	noir, negro, schwarz, crna	5901867193438



FR Connecteur 3 circuits en "L" 90°  
 ES Conector "L"  
 DE "L" Verbindungsstück  
 HR L-spojnicica

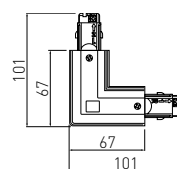
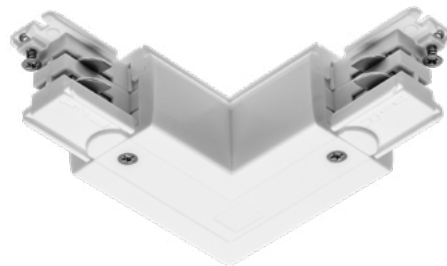

XAE-LKLPWB-00	blanc, blanco, weiß, bijeli	5901867193407
XAE-LKLPWC-10	noir, negro, schwarz, crna	5901867193414





FR Embout  
ES Terminales de carril conductor  
DE Schienensystemendkappe  
HR Završna kapa šine

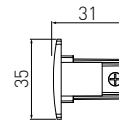
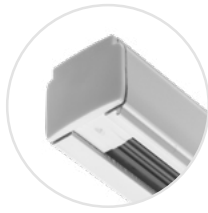

XAE-ZKUNCB-00	blanc, blanco, weiß, bijeli	5901867193346
XAE-ZKUNCC-10	noir, negro, schwarz, crna	5901867193353

FR Connecteur 3 circuits  
ES Conector recto articulado  
DE Gerades Verbindungsstück  
HR Spojnica ravna

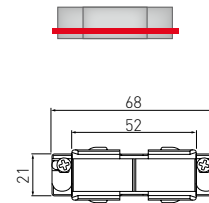

XAE-LKELB-00	blanc, blanco, weiß, bijeli	5901867193360
XAE-LKELC-10	noir, negro, schwarz, crna	5901867193377



FR Connecteur 3 circuits en "X"  
ES Conector en Cruz  
DE "X" Verbindungsstück  
HR X-spojnica

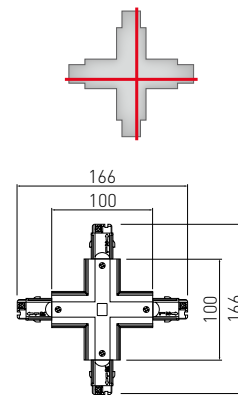
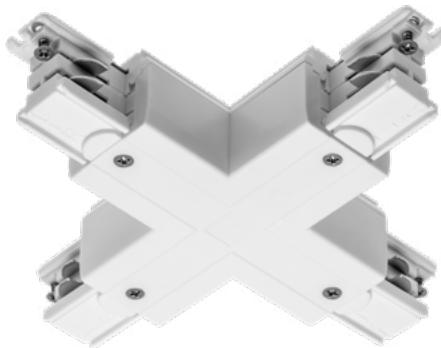

XAE-LKXUB-00	blanc, blanco, weiß, bijeli	5901867193445
XAE-LKXUC-10	noir, negro, schwarz, crna	5901867193452



FR Connecteur 3 circuits en "T" ajustable  
 ES "T" ajustable, regulable  
 DE "T" Verbindungsstück, regulierbar  
 HR T-spojnicica s regulacijom

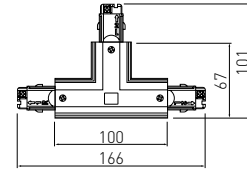
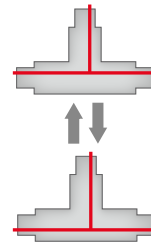
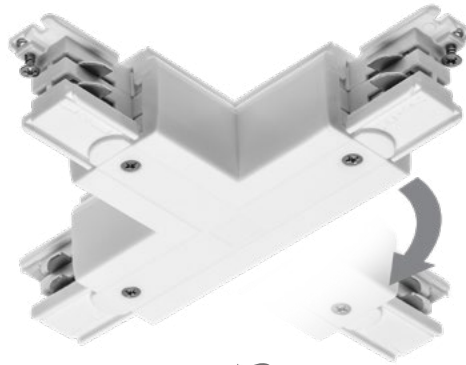

XAE-LKTRZWLB-00	blanc, blanco, weiß, bijeli	5901867193582
XAE-LKTRZWLC-10	noir, negro, schwarz, crna	5901867193599



FR Connecteur 3 circuits en "T"  
 ES Conector "T"  
 DE "T" Verbindungsstück  
 HR T-spojnicica

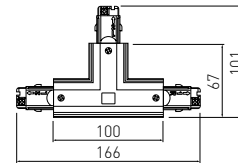
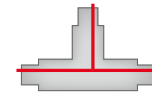
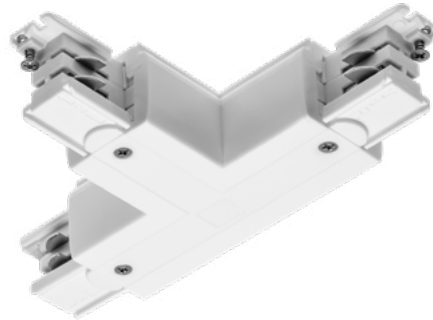

XAE-LKTWLB-00	blanc, blanco, weiß, bijeli	5902801001307
XAE-LKTWLC-10	noir, negro, schwarz, crna	5902801001314



FR Connecteur 3 circuits en "T"  
 ES Conector "T"  
 DE "T" Verbindungsstück  
 HR T-spojnicica

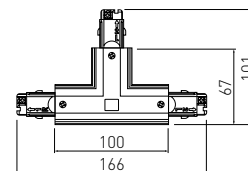
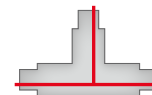
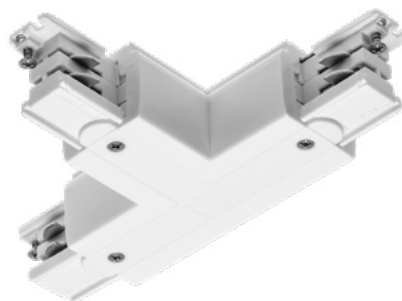

XAE-LKTZLB-00	blanc, blanco, weiß, bijeli	5901867193483
XAE-LKTZLC-10	noir, negro, schwarz, crna	5901867193490



FR Connecteur 3 circuits en "T" ajustable  
 ES "T" ajustable, regulable  
 DE "T" Verbindungsstück, regulierbar  
 HR T-spojnic s regulacijom

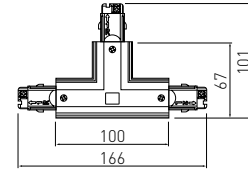
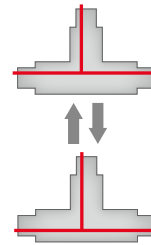
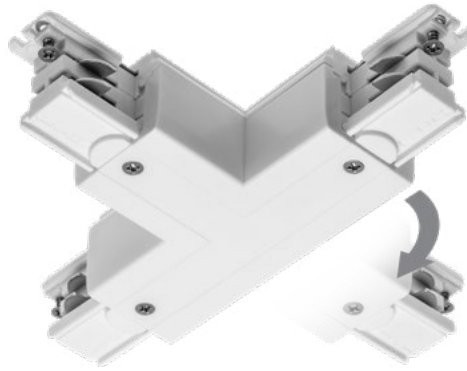

XAE-LKTRZWPB-00	blanc, blanco, weiß, bijeli	5901867193568
XAE-LKTRZWPC-10	noir, negro, schwarz, crna	5901867193575



FR Connecteur 3 circuits en "T"  
 ES Conector "T"  
 DE "T" Verbindungsstück  
 HR T-spojnic

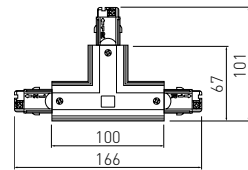
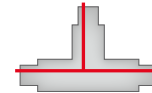
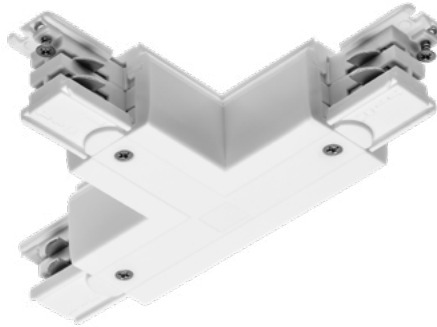

XAE-LKTWPB-00	blanc, blanco, weiß, bijeli	5902801001284
XAE-LKTWPC-10	noir, negro, schwarz, crna	5902801001291



FR Connecteur 3 circuits en "T"  
 ES Conector "T"  
 DE "T" Verbindungsstück  
 HR T-spojnic

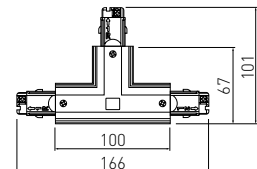
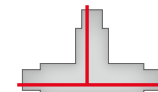
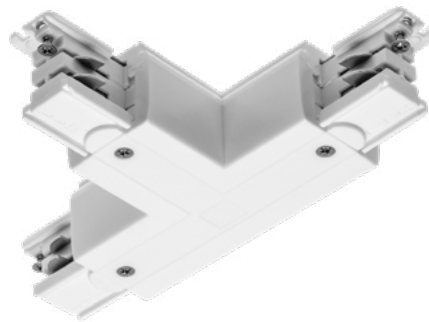

XAE-LKTZPB-00	blanc, blanco, weiß, bijeli	5901867193469
XAE-LKTZPC-10	noir, negro, schwarz, crna	5901867193476





FR Connecteur 3 circuits  
ES Conector recto articulado  
DE Gerades Verbindungsstück  
HR Spojnica ravna

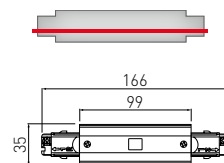
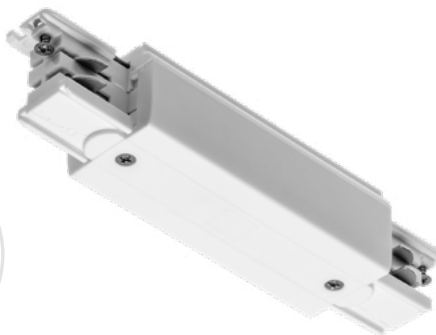

XAE-LELZB-00	blanc, blanco, weiß, bijeli	5901867193384
XAE-LELZC-10	noir, negro, schwarz, crna	5901867193391



FR Connecteur 3 circuits ajustable  
ES Conector recto articulado  
DE Regulierbares Verbindungsstück  
HR Spojnica s regulacijom

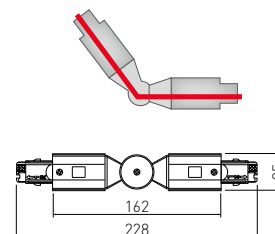
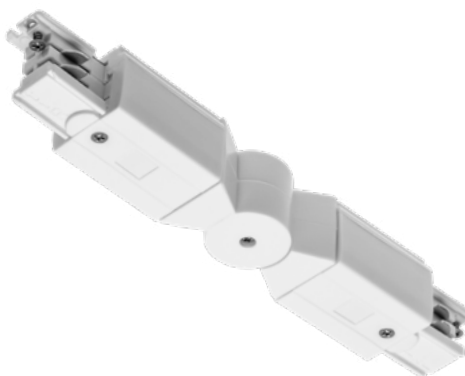

XAE-LKRUB-00	blanc, blanco, weiß, bijeli	5901867193520
XAE-LKRUC-10	noir, negro, schwarz, crna	5901867193537



FR Connecteur 3 circuits flexible  
ES Conector flexible  
DE Elastisches Verbindungsstück  
HR Fleksibilna spojnica

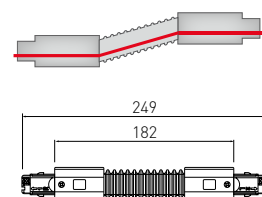
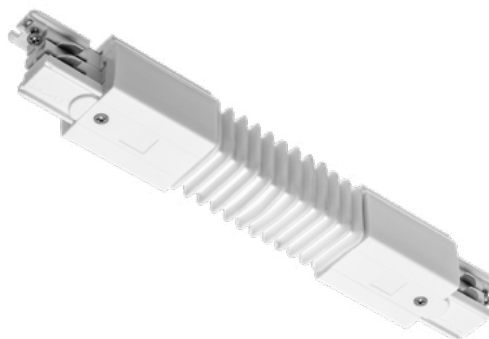

XAE-LELUB-00	blanc, blanco, weiß, bijeli	5901867193506
XAE-LELUC-10	noir, negro, schwarz, crna	5901867193513



FR Kit de suspension  
ES Fijación para techo  
DE Deckenhalterung  
HR Stropni nosač



XAE-MSUNB-00	blanc, blanco, weiß, bijeli	5901867193766
XAE-MSUNC-10	noir, negro, schwarz, crna	5901867193773

FR Kit de suspension plafond avec câble  
ES Juego para fijación a techo E-Z Click con cable  
DE Deckenhalterung für Schienensystem (Set E-Z Click mit Seil)  
HR Set za ovesnu montažu E-Z Click

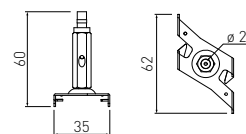
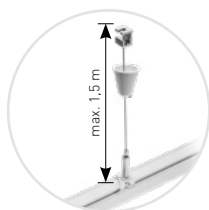

XAE-ZZWECLB-00	blanc, blanco, weiß, bijeli	5901867193605
XAE-ZZWECLC-10	noir, negro, schwarz, crna	5901867193612

FR Kit de suspension plafond avec câble  
ES Juego de fijación a techo 120 mm con cable  
DE Deckenhalterung für Schienensystem (Set)  
HR Set za ovesnu montažu s pločicom

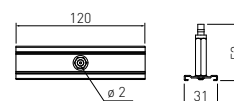
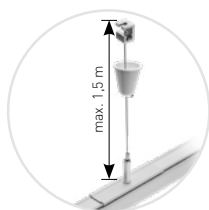

XAE-ZZWL120B-00	blanc, blanco, weiß, bijeli	5901867193667
XAE-ZZWL120C-10	noir, negro, schwarz, crna	5901867193674



- FR Pince de suspension pour connexion rail  
 ES Conector mecánico 182 mm  
 DE Mechanisches Verbindungsstück  
 HR Mehanička spojnica 182 mm



XAE-LMIZB-00	blanc, blanco, weiß, bijeli	5901867193742
XAE-LMIZC-10	noir, negro, schwarz, crna	5901867193759

- FR Kit Montage barrre "T"  
 ES Conector de montaje E-Z Click T25  
 DE Deckenhalterung für Schienensystem (Set E-Z Click T25)  
 HR Spojnica E-Z Click T25



XAE-MSEZB-00	blanc, blanco, weiß, bijeli	5901867193629
XAE-MSEZC-10	noir, negro, schwarz, crna	5901867193636

- FR Kit montage profil T25  
 ES Fijación para techo 120 mm T25  
 DE Deckenhalterung T25  
 HR Stropni nosač 120 mm T25

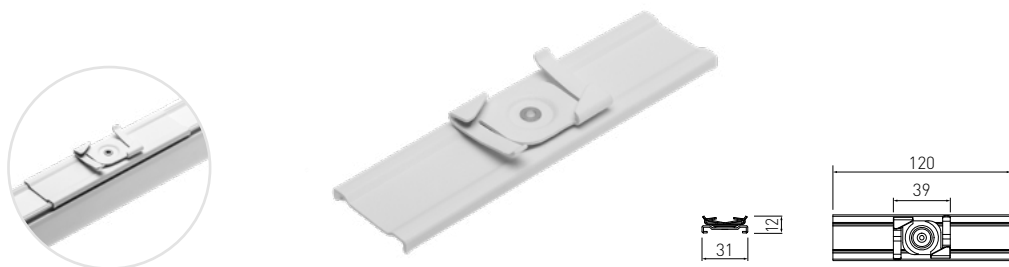

XAE-MS120B-00	blanc, blanco, weiß, bijeli	5901867193704
XAE-MS120C-10	noir, negro, schwarz, crna	5901867193711





FR Base pour montage en surface  
 ES Base para montaje en superficie  
 DE Basis für Aufputzmontage  
 HR Baza za nadgradnu montažu

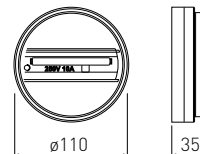

XAE-BNADB-00	blanc, blanco, weiß, bijeli	5901867193780
XAE-BNADC-10	noir, negro, schwarz, crna	5901867193797

FR Crochet de suspension  
 ES Gancho para colgar  
 DE Aufhängehaken  
 HR Kuka za vješanje

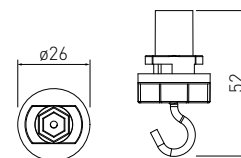

XAE-HMKB-00	blanc, blanco, weiß, bijeli	5901867193728
XAE-HMKC-10	noir, negro, schwarz, crna	5901867193735

FR Prise Shucko  
 ES Toma SCHUKO  
 DE Buchse SCHUKO  
 HR Schuko utičnica

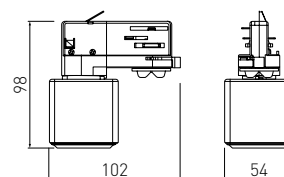

XAE-GNSCH-00	blanc, blanco, weiß, bijeli	5901867193803
--------------	-----------------------------	---------------



Embout  
 Terminales de carril conductor  
 Schienensystemendkappe  
 Završna kapa šine

Connecteur 3 circuits en "X"  
 Conector "X"  
 "X" Verbindungsstück  
 X-spojnica

Connecteur 3 circuits en "T"  
 Conector "T"  
 "T" Verbindungsstück  
 T-spojnica

Connecteur 3 circuits en "L" 90°  
 Conector "L"  
 "L" Verbindungsstück  
 L-spojnica

Connecteur 3 circuits  
 Conector recto  
 Gerades Verbindungsstück  
 Spojnica ravna



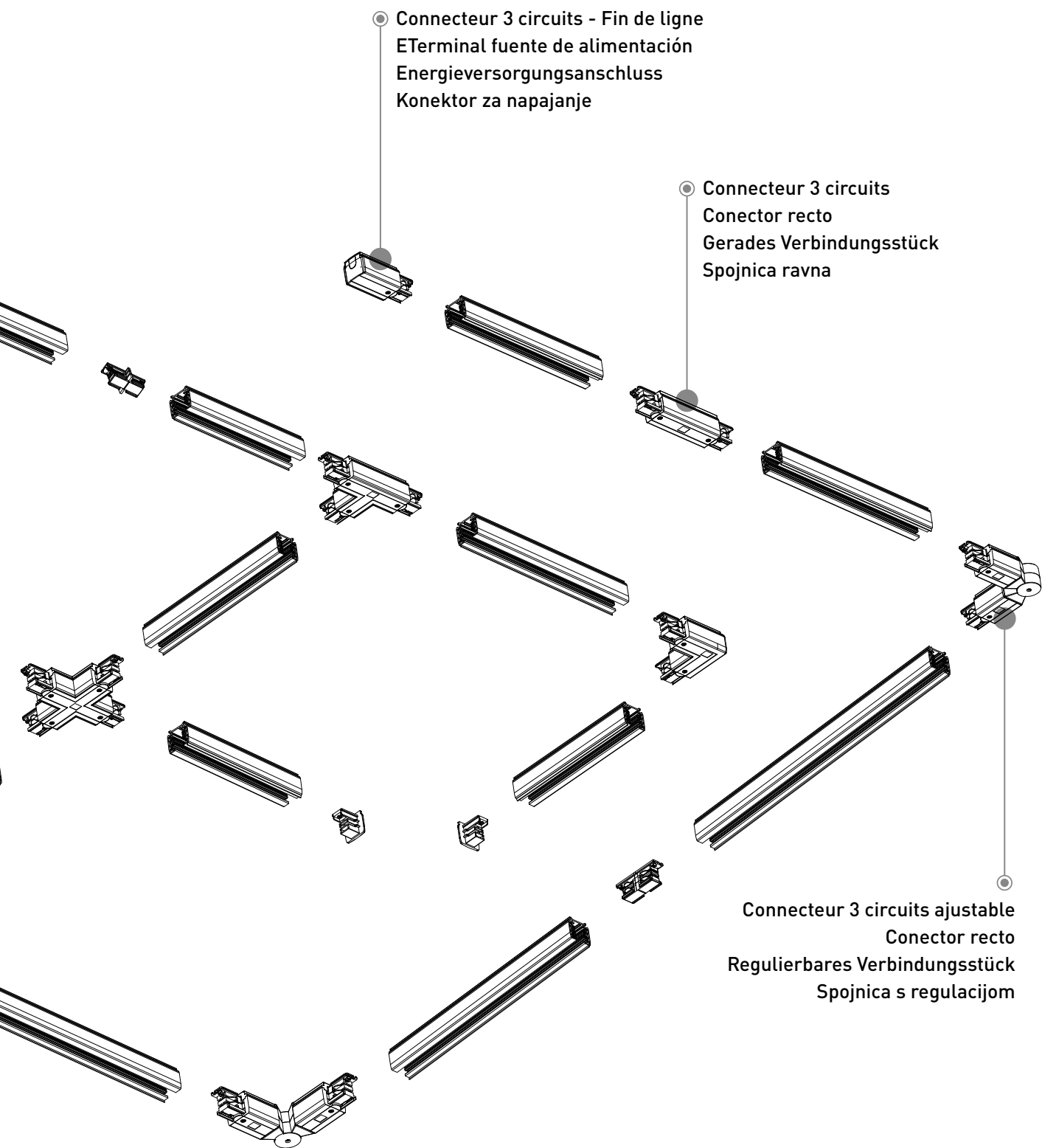

● Connecteur 3 circuits - Fin de ligne  
E Terminal fuente de alimentación  
Energieversorgungsanschluss  
Konektor za napajanje

● Connecteur 3 circuits  
Conector recto  
Gerades Verbindungsstück  
Spojnica ravna

● Connecteur 3 circuits ajustable  
Conector recto  
Regulierbares Verbindungsstück  
Spojnica s regulacijom



FR Diagramme de connexion  
 ES Esquema de conexión  
 DE Verbindungsschema  
 HR Shema spajanja

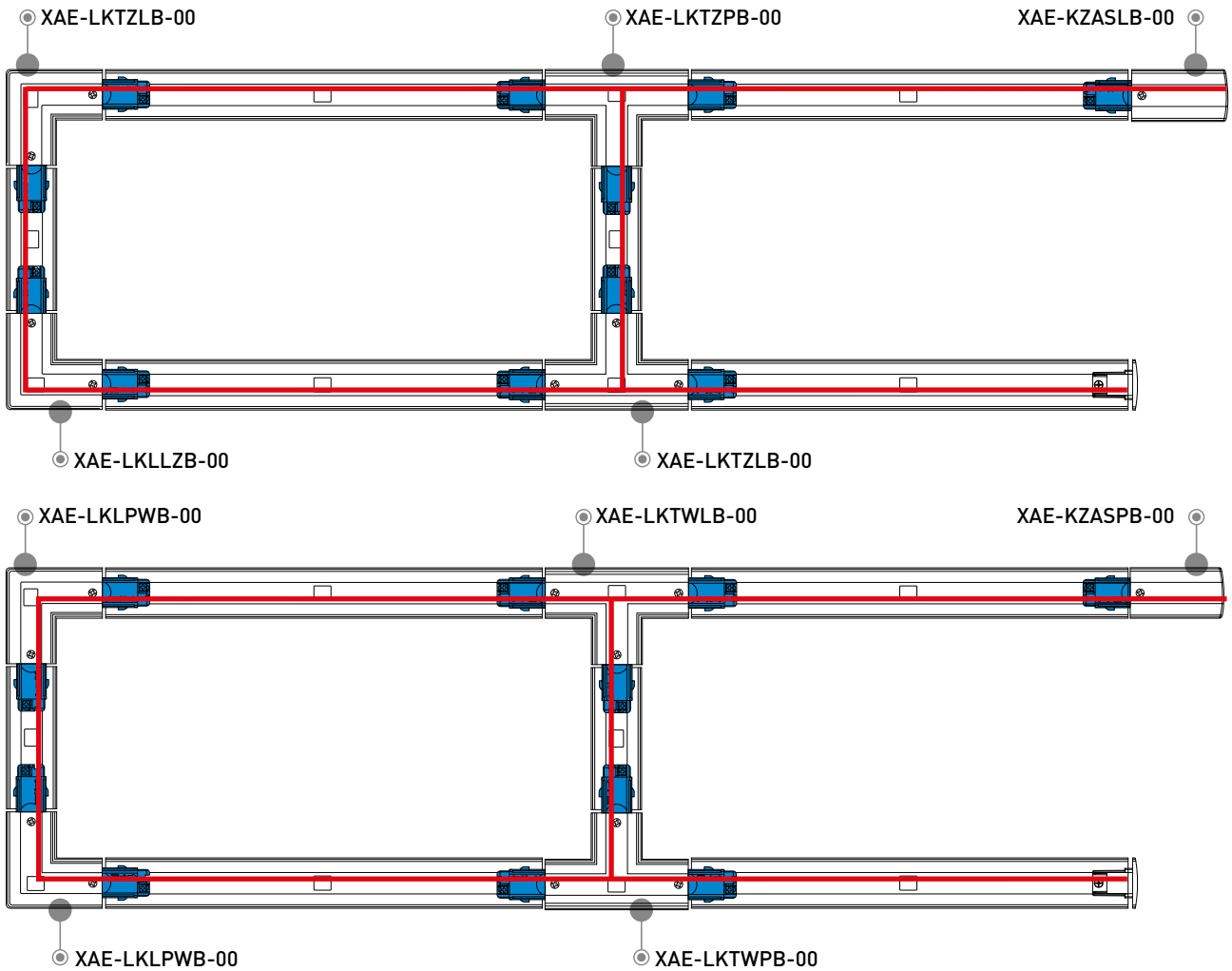

Le track est asymétrique - en choisissant les éléments, assurez-vous que la piste N est continue.

El carril conductor es asimétrico: preste atención a la continuidad de la pista N al seleccionar los elementos.

Die Spur ist asymmetrisch- bei der Auswahl der Elemente ist es notwendig auf die Kontinuität der N-Leitung zu achten"

Šina je asimetrična - pri odabiru elemenata treba obratiti pažnju na kontinuitet vodiča N.

Sur les dessins, le track N est marqué d'une ligne rouge.

En los planos, la pista N está señalada con línea roja.

In den Zeichnungen ist die N-Leitung durch eine rote Linie markiert

Na crtežima vodič N označena je sa crvenom bojom.









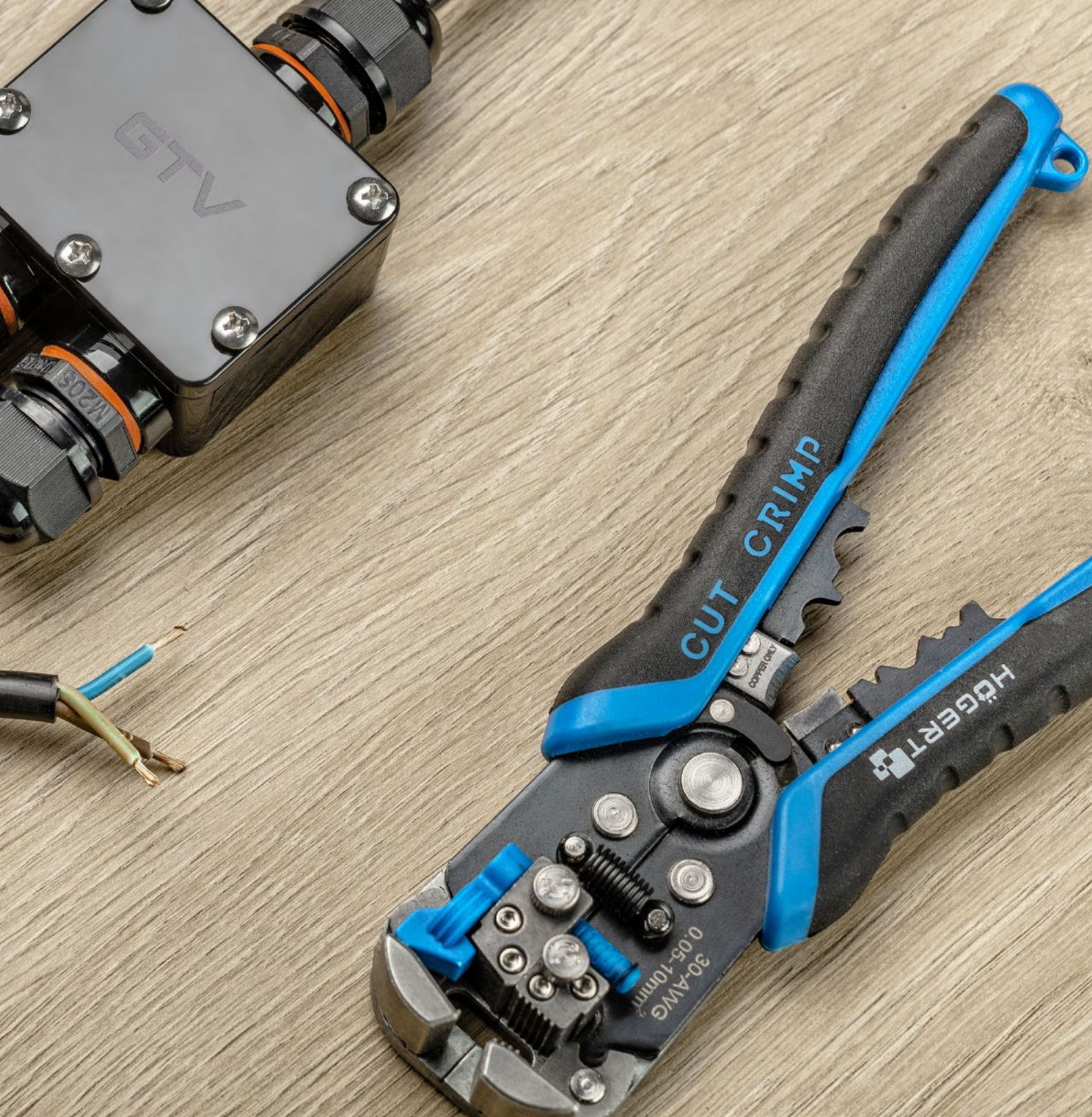

EQUIPEMENT D'INSTALLATION ÉLECTRIQUE  
ACCESORIOS PARA INSTALACIONES ELÉCTRICAS  
ELEKTROINSTALLATIONS AUSRÜSTUNG  
ELEKTROMATERIJAL I PRIBOR

Equipement d'installation électrique  
Accesorios para instalaciones eléctricas  
Elektroinstallationsausrüstung  
Elektromaterijal i pribor.....355







	CR-1	CR-2	CR-3	CR-3 Mini	CR-4LED
					
IP	IP-44	IP-44	IP-20	IP-20	IP-20
charge max. incandescente carga máx. incandescente Maximale Belastungslast Glühlampe max. opterećenje žarulja	1200W	1200W	1200W	2000W	1200W
charge max. LED carga máx LED Maximale Belastung LED max. LED opterećenje	300W	300W	300W	1000W	300W
GAMME (plafond) ALCANCE (techo) REICHWEITE (Decke) RASPON (strop)	-	-			-
hauteur de montage altura de instalación Montagehöhe visina montaže	-	-	2,2-4 m	2,2-4 m	-
gamme alcance Reichweite raspon	-	-	6 m	6 m	-
GAMME (mur) ALCANCE (pared) REICHWEITE (Wand) RASPON (zid)			-	-	
hauteur de montage altura de instalación Montagehöhe visina montaže	1,8-2,5 m	1,8-2,5 m	-	-	1-1,8 m
gamme alcance Reichweite raspon	10 m	8 m	-	-	9 m
connexion (2-3-4 fils) conexión (2-3-4 hilos) Anschluss (2-3-4 Drähte) veza (2-3-4 žice)	3	3	3	3	3
réglage du seuil de luminosité ajuste del umbral de luminosidad Einstellung der Helligkeitsschwelle podešavanje praga svjetline	3-2000 lx	3-2000 lx	3-2000 lx	3-2000 lx	3-2000 lx
réglage du temps d'éclairage après la disparition du mouvement ajuste del tiempo de iluminación tras la desaparición del movimiento Einstellung der Beleuchtungszeit nach Verschwinden der Bewegung postavljanje vremena osvjetljenja nakon prestanka kretanja	10 s ± 3 s / 7min ± 2min	10 s ± 3 s / 7min ± 2min	10 s ± 3 s / 7min ± 2min	10 s ± 3 s / 15min ± 2min	10 s ± 3 s / 7min ± 2min





CR-5	CR-5Mini	CR-6	CR-7	CR-8	CR-9
------	----------	------	------	------	------



IP-20	IP-20	IP-20	IP-20	IP-20	IP-65
1200W	800W	60W	800W	400W	1200W
300W	400W	60W	400W	200W	300W
			-		-
2,2-4 m	2,2-4 m	2-3,5 m	-	2,2-4 m	-
6 m	6 m	6 m	-	4+4 m	-
-	-	-		-	
-	-	-	1,8-2,5 m	-	2,5-3,5 m
-	-	-	6 m	-	2-8 m
3	3	E27	3	4	3
3-2000 lx	3-2000 lx	3-2000 lx	10/2000lx	3-2000 lx	3-2000 lx
10 s ± 3 s / 15min ± 2min	10 s ± 3 s / 15min ± 2min	10 s ± 3 s / 5min ± 1min	5s + 30s + 1min + 3min + 5min + 8min	10 s ± 3 s / 7min ± 2min	10 s ± 3 s / 7min ± 2min

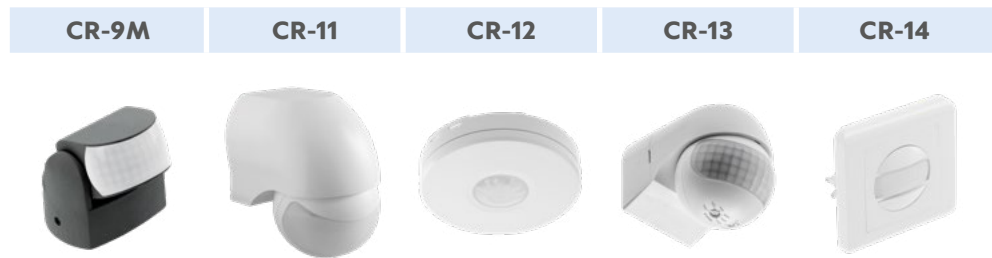

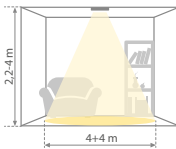
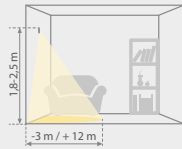
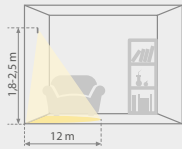
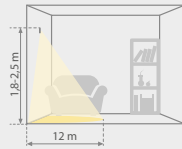
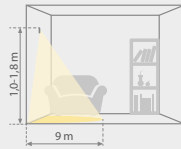
	CR-9M	CR-11	CR-12	CR-13	CR-14
<b>IP</b>	IP-65	IP-44	IP-65	IP-44	IP-20
<b>charge max. incandescente carga máx. incandescente Maximale Belastungslast Glühlampe max. opterećenje žarulja</b>	1200W	1200W	2000W	800W	300W
<b>charge max. LED carga máx LED Maximale Belastung LED max. LED opterećenje</b>	600W	300W	1000W	400W	150W
<b>GAMME (plafond) ALCANCE (techo) REICHWEITE (Decke) RASPON (strop)</b>	-	-		-	-
<b>hauteur de montage altura de instalación Montagehöhe visina montaže</b>	-	-	2,2-4 m	-	-
<b>gamme alcance Reichweite raspon</b>	-	-	4+4 m	-	-
<b>GAMME (mur) ALCANCE (pared) REICHWEITE (Wand) RASPON (zid)</b>			-		
<b>hauteur de montage altura de instalación Montagehöhe visina montaže</b>	1,8-2,5 m	1,8-2,5 m	-	1,8-2,5 m	1,0-1,8 m
<b>gamme alcance Reichweite raspon</b>	-3 m / +12 m	12 m	-	12 m	9 m
<b>connexion (2-3-4 fils) conexión (2-3-4 hilos) Anschluss (2-3-4 Drähte) veza (2-3-4 žice)</b>	3	3	4	3	2
<b>réglage du seuil de luminosité ajuste del umbral de luminosidad Einstellung der Helligkeitsschwelle podešavanje praga svjetline</b>	3-2000 lx	3-2000 lx	3-2000 lx	3-2000 lx	3-2000 lx
<b>réglage du temps d'éclairage après la disparition du mouvement ajuste del tiempo de iluminación tras la desaparición del movimiento Einstellung der Beleuchtungszeit nach Verschwinden der Bewegung postavljanje vremena osvjetljenja nakon prestanka kretanja</b>	10 s ± 3 s/ 15min ± 2min	10 s ± 3 s/ 7min ± 2min	10 s ± 3 s/ 30min ± 2min	10 s ± 3 s/ 15min ± 2min	10 s ± 3 s/ 7min ± 2min







CR-15	CR-16	CR-17	CR-18	CR-19	CO-1	CO-2
-------	-------	-------	-------	-------	------	------



IP-20	IP20	IP-65	IP-20	IP44	IP-20	IP-65
800W	500W	800W	500W	2000W	2000W	2000W
400W	200W	400W	200W	1000W	1000W	1000W
	-					
2,2-4 m	-	2,2-4 m	2,2-4 m	2,2-6 m	2,2-6 m	2,2-4 m
4+4 m	-	-2 m / + 10 m	3+3 m	10+10 m	10+10 m	motion 10+10 m, presence 3+3 m
-				-	-	-
-	1,0-1,8 m	1,8-2,5 m	1,8-2,5 m	-	-	-
-	4-9 m	-2 m / + 10 m	8 m	-	-	-
3	2	3	4	4	3	4
3-2000 lx	3-2000 lx	3-2000 lx	3-2000 lx	3-2000 lx	3-2000 lx	3-2000 lx
10 s ± 3 s/ 15min ± 2min	10 s ± 3 s/ 7min ± 2min	10 s ± 3 s/ 15min ± 2min	10 s ± 3 s/ 15min ± 30 s	10 s ± 3 s/ 30min ± 2min	10 s ± 3 s/ 30min ± 2min	10 s ± 3 s/ 30min ± 2min

FR Détecteur de mouvement  
ES Detector de movimiento  
DE Bewegungsmelder  
HR Senzor pokreta

## CR-1



White

Black

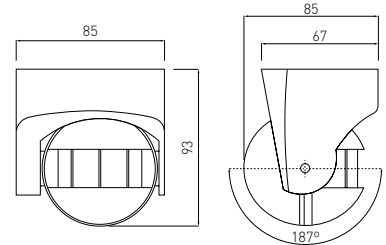

CR-CR1000-10	Plastique, plastico, Kunststoff, plastika	noir, negro, schwarz, crna	160 g	5908231308184
CR-CR1000-00		blanc, blanco, weiß, bijeli		5908231308160



FR Détecteur de mouvement  
ES Detector de movimiento  
DE Bewegungsmelder  
HR Senzor pokreta

## CR-2



White

Black

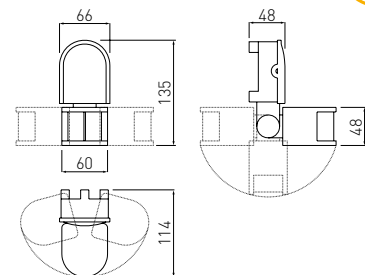

CR-CR2000-10	Plastique, plastico, Kunststoff, plastika	noir, negro, schwarz, crna	180 g	5908231308238
CR-CR2000-00		blanc, blanco, weiß, bijeli		5908231308207



FR Détecteur de mouvement  
ES Detector de movimiento  
DE Bewegungsmelder  
HR Senzor pokreta

## CR-3



White

Black

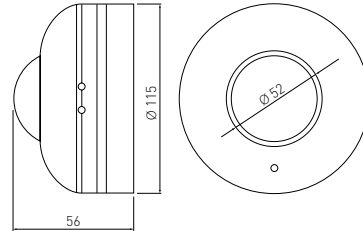

CR-CR3000-10	Plastique, plastico, Kunststoff, plastika	noir, negro, schwarz, crna	170 g	5902801342172
CR-CR3000-00		blanc, blanco, weiß, bijeli		5908231308146



FR Détecteur de mouvement  
ES Detector de movimiento  
DE Bewegungsmelder  
HR Senzor pokreta

## CR-3 MINI



White

Black

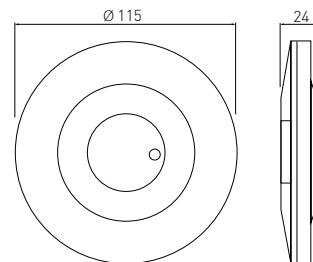

CR-CR3M00-10	Plastique, plastico, Kunststoff, plastika	noir, negro, schwarz, crna	100 g	5902801342301
CR-CR3M00-00		blanc, blanco, weiß, bijeli		5901867146076



Elektro-  
installationsausrüstung



FR Détecteur de mouvement  
ES Detector de movimiento  
DE Bewegungsmelder  
HR Senzor pokreta

## CR-4LED

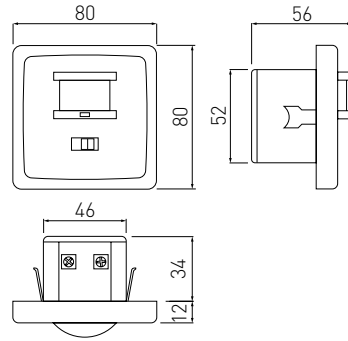

CR-CR4L00-00	Plastique, plastico, Kunststoff, plastika	blanc, blanco, weiß, bijeli	100 g	5908231308122
--------------	---	-----------------------------	-------	---------------



FR Détecteur de mouvement  
ES Detector de movimiento  
DE Bewegungsmelder  
HR Senzor pokreta

## CR-5

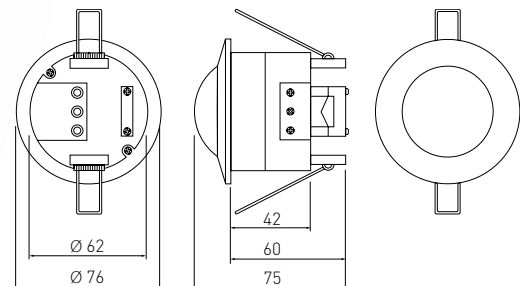

CR-CR5000-00	Plastique, plastico, Kunststoff, plastika	blanc, blanco, weiß, bijeli	100 g	5908231308115
--------------	---	-----------------------------	-------	---------------



FR Détecteur de mouvement encastrable  
 ES Detector de movimiento empotrable  
 DE Einlass-Bewegungsmelder  
 HR Senzor pokreta ugradni

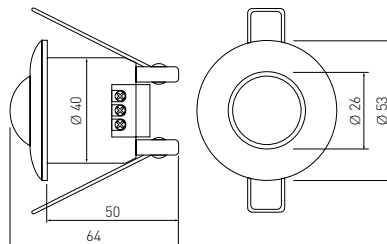
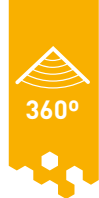

CR-CR5M00-00	Plastique, plastico, Kunststoff, plastika	blanc, blanco, weiß, bijeli	50 g	5901867108890
--------------	---	-----------------------------	------	---------------



FR Capteur de mouvement infrarouge  
 ES Sensor de movimiento infrarrojo  
 DE IR-Bewegungsmelder  
 HR Infracrveni senzor pokreta

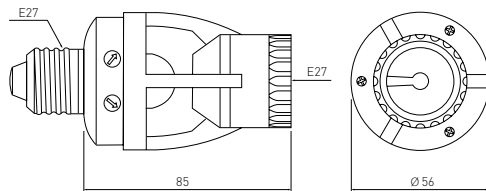

CR-CR6000-00	Plastique, plastico, Kunststoff, plastika	blanc, blanco, weiß, bijeli	80 g	5901867103437
--------------	---	-----------------------------	------	---------------



Elektro-  
installationsausrüstung

FR Détecteur de mouvement avec capteur IR externe  
 ES Detector de movimiento con sensor IR externo  
 DE Bewegungsmelder mit externem IR-Sensor  
 HR Senzor pokreta s vanjskim infracrvenim senzorum

CR-7

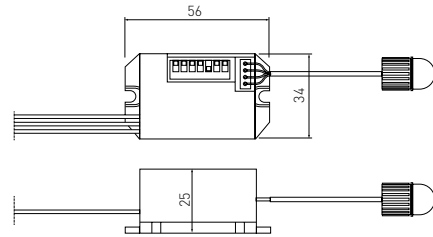
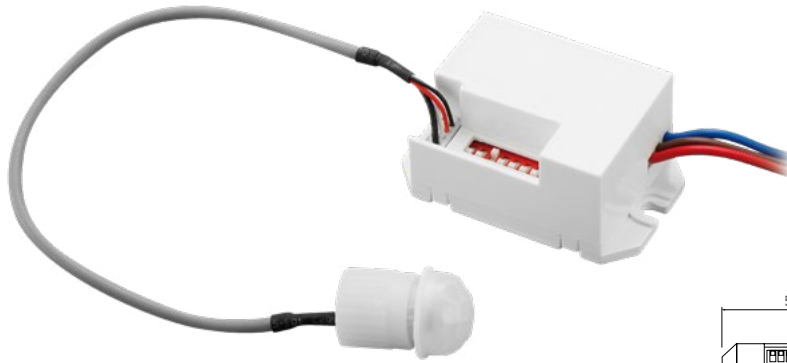

CR-CR7000-00	Plastique, plastico, Kunststoff, plastika	blanc, blanco, weiß, bijeli	170 g	5901867103444
--------------	---	-----------------------------	-------	---------------



FR Détecteur de mouvement  
 ES Detector de movimiento  
 DE Bewegungsmelder  
 HR Senzor pokreta

CR-8

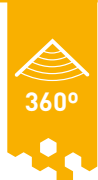
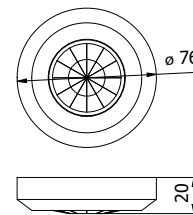

CR-CR8000-00	Plastique, plastico, Kunststoff, plastika	blanc, blanco, weiß, bijeli	50 g	5902801294969
--------------	---	-----------------------------	------	---------------





FR Détecteur de mouvement  
ES Detector de movimiento  
DE Bewegungsmelder  
HR Senzor pokreta

## CR-9



White

Black

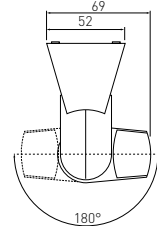
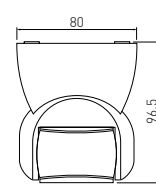

CR-CR9000-00	Plastique, plastico, Kunststoff, plastika	blanc, blanco, weiß, bijeli	5901867108906
CR-CR9000-10		noir, negro, schwarz, crna	5901867138507



FR Détecteur de mouvement  
ES Detector de movimiento  
DE Bewegungsmelder  
HR Senzor pokreta

## CR-9 mini



White

Black

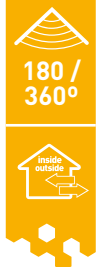
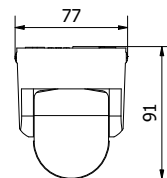
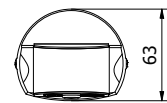

CR-CR9M00-00	PC	blanc, blanco, weiß, bijeli	120 g	5902801294433
CR-CR9M00-10		noir, negro, schwarz, crna		5902801294518



FR Capteur de mouvement et de présence  
 ES Sensor de movimiento y presencia  
 DE Bewegungs- und Anwesenheits-Melder  
 HR Osjetnik za pokret i nazočnost

CO-1

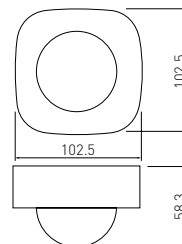

CR-CO1000-00	Plastique, plastico, Kunststoff, plastika	blanc, blanco, weiß, bijeli	140 g	5901867146090



FR Capteur de mouvement et de présence  
 ES Sensor de movimiento y presencia  
 DE Bewegungs- und Anwesenheits-Melder  
 HR Osjetnik za pokret i nazočnost

CO-2

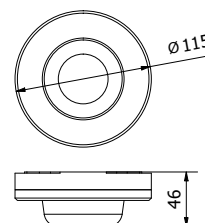

CR-CO2000-00	1000 W	2000 W	Plastique, plastico, Kunststoff, plastika	blanc, blanco, weiß, bijeli	150 g	5902801261534



Elektro-  
installationsausrüstung



FR Capteur de mouvement et de présence  
 ES Sensor de movimiento y presencia  
 DE Bewegungs- und Anwesenheits-Melder  
 HR Osjetnik za pokret i nazočnost

CR-11

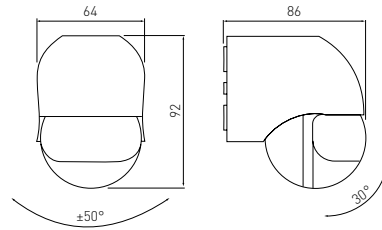
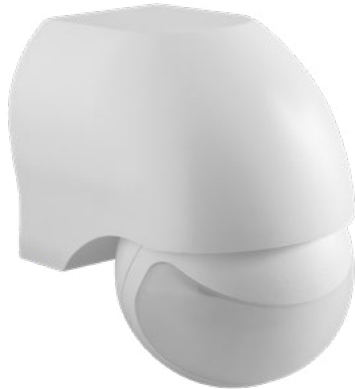

180°  
 PIR  
 5 years warranty

CR-CR1100-00	Plastique, plastico, Kunststoff, plastika	blanc, blanco, weiß, bijeli	160 g	5901867108913

220-240 V 50-60 Hz | MAX 1200 W | IP20 | | 180° | 2-8 m | LED | -5°C +25°C | 2,5 mm² | CE | EAC | UK CA | |

FR Détecteur de mouvement  
 ES Detector de movimiento  
 DE Bewegungsmelder  
 HR Senzor pokreta

CR-12

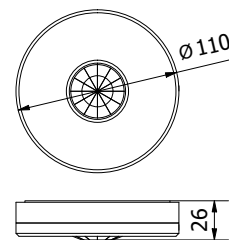

360°  
  
 PIR  
 5 years warranty

CR-CR1200-00	1000 W	2000 W	Plastique, plastico, Kunststoff, plastika	blanc, blanco, weiß, bijeli	130 g	5902801261664

220-240 V 50-60 Hz | IP65 | | 360° | MAX 4m | LED | -10°C +30°C | 2,5 mm² | CE | EAC | UK CA | |

Elektro-  
 installationsausrüstung



FR Détecteur de mouvement  
ES Detector de movimiento  
DE Bewegungsmelder  
HR Senzor pokreta

## CR-13

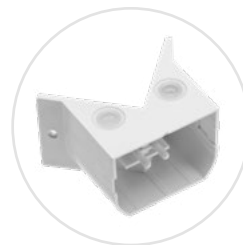

Montage en coin,  
Montaje en esquina,  
Eckmontage,  
Kutna montaža

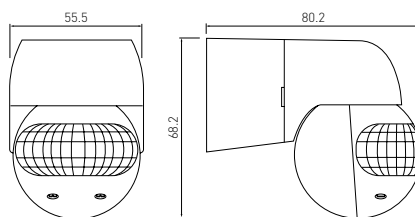

CR-CR13000-00	Plastique, plastico, Kunststoff, plastika	blanc, blanco, weiß, bijeli	120 g	5901867188274
---------------	---	-----------------------------	-------	---------------



FR Détecteur de mouvement  
ES Detector de movimiento  
DE Bewegungsmelder  
HR Senzor pokreta

## CR-14

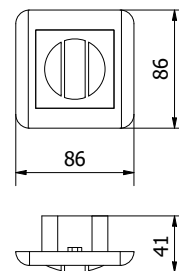

CR-CR1400-00	Plastique, plastico, Kunststoff, plastika	blanc, blanco, weiß, bijeli	82 g	5902801294174
--------------	---	-----------------------------	------	---------------



FR Détecteur de mouvement  
ES Detector de movimiento  
DE Bewegungsmelder  
HR Senzor pokreta

## CR-15

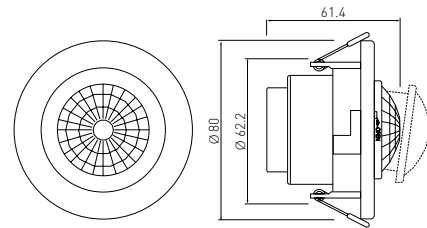

CR-CR15000-00	Plastique, plastico, Kunststoff, plastika	blanc, blanco, weiß, bijeli	90 g	5901867188212
---------------	---	-----------------------------	------	---------------



FR Détecteur de mouvement  
ES Detector de movimiento  
DE Bewegungsmelder  
HR Senzor pokreta

## CR-16

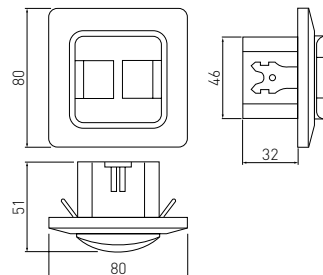

CR-CR16000-00	Plastique, plastico, Kunststoff, plastika	blanc, blanco, weiß, bijeli	88 g	5902801002533
---------------	---	-----------------------------	------	---------------



Elektro-  
installationsausrüstung

FR Détecteur de mouvement  
ES Detector de movimiento  
DE Bewegungsmelder  
HR Senzor pokreta

CR-17

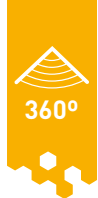
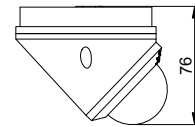
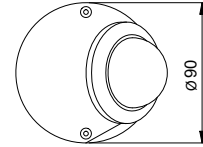

CR-CR17000-00	Plastique, plastico, Kunststoff, plastika	blanc, blanco, weiß, bijeli	55 g	5902801282102
---------------	---	-----------------------------	------	---------------



FR Détecteur de mouvement  
ES Detector de movimiento  
DE Bewegungsmelder  
HR Senzor pokreta

CR-18

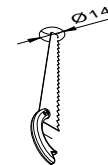
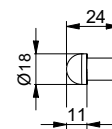
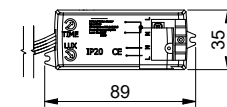
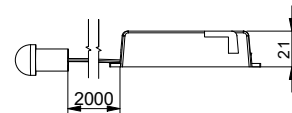

CR-CR18000-00	PC	blanc, blanco, weiß, bijeli	55 g	5902801282058
---------------	----	-----------------------------	------	---------------



Elektro-  
installationsausrüstung





FR Détecteur de mouvement  
ES Detector de movimiento  
DE Bewegungsmelder  
HR Senzor pokreta

## CR-19

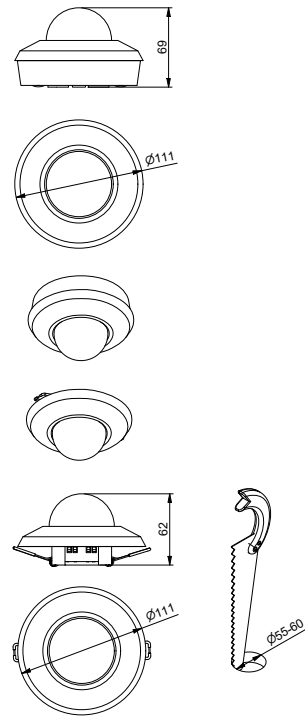

CR-CR19000-00

PC

blanc, blanco, weiß, bijeli

170 g

5902801282140



FR Détecteur de mouvement à micro-ondes  
ES Detector de movimiento por microondas  
DE Mikrowellenbewegungssensor  
HR Senzor pokreta mikrovalni

## CM-1

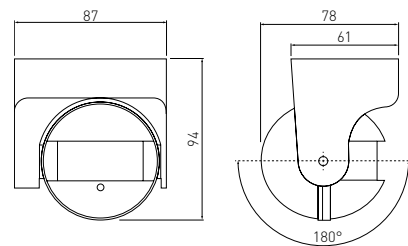

AE-CM1000-00

Plastique, plastico, Kunststoff, plastika

blanc, blanco, weiß, bijeli

160 g

5901867108876



FR Détecteur de mouvement à micro-ondes  
 ES Detector de movimiento por microondas  
 DE Mikrowellenbewegungssensor  
 HR Senzor pokreta mikrovalni

## CM-3

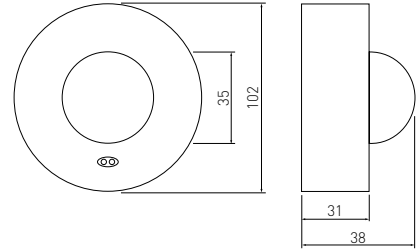

AE-CM3000-00	Plastique, plastico, Kunststoff, plastika	blanc, blanco, weiß, bijeli	170 g	5908231339997



FR Détecteur de mouvement à micro-ondes  
 ES Detector de movimiento por microondas  
 DE Mikrowellenbewegungssensor  
 HR Senzor pokreta mikrovalni

## CM-3 MINI



White

Black

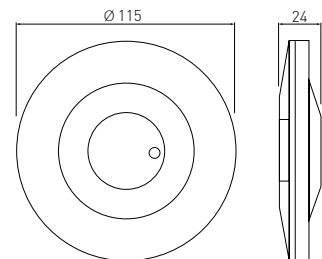

AE-CM3M00-00	Plastique, plastico, Kunststoff, plastika	blanc, blanco, weiß, bijeli	110 g	5901867188250
AE-CM3M00-10				5902801458552



FR Détecteur de mouvement à micro-ondes  
 ES Detector de movimiento por microondas  
 DE Mikrowellenbewegungssensor  
 HR Senzor pokreta mikrovalni

**CM-4**

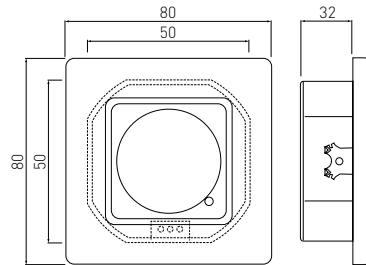

AE-CM4000-00	Plastique, plastico, Kunststoff, plastika	blanc, blanco, weiß, bijeli	90 g	5901867188236
--------------	---	-----------------------------	------	---------------



FR Détecteur de mouvement à micro-ondes  
 ES Detector de movimiento por microondas  
 DE Mikrowellenbewegungssensor  
 HR Senzor pokreta mikrovalni

**CM-5**

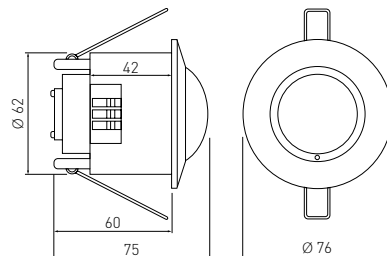

AE-CM5000-00	Plastique, plastico, Kunststoff, plastika	blanc, blanco, weiß, bijeli	100 g	5901867108883
--------------	---	-----------------------------	-------	---------------



Elektro-  
installationsausrüstung



FR Détecteur de mouvement à micro-ondes  
 ES Detector de movimiento por microondas  
 DE Mikrowellenbewegungssensor  
 HR Senzor pokreta mikrovalni

CM-6

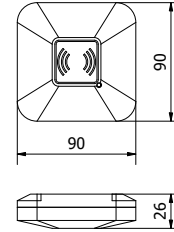

AE-CM6000-00	400 W	800 W	PC	blanc, blanco, weiß, bijeli	100 g	5902801285189



FR Détecteur de mouvement à micro-ondes  
 ES Detector de movimiento por microondas  
 DE Mikrowellenbewegungssensor  
 HR Senzor pokreta mikrovalni

CM-9



White

Black

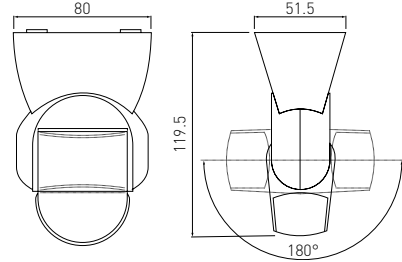

AE-CM9000-00	Plastique, plastico, Kunststoff, plastika	blanc, blanco, weiß, bijeli	161 g	5901867196972
AE-CM9000-10		noir, negro, schwarz, crna		5901867196996



FR Détecteur de mouvement à micro-ondes  
 ES Detector de movimiento por microondas  
 DE Mikrowellenbewegungssensor  
 HR Senzor pokreta mikrovalni

CM-15

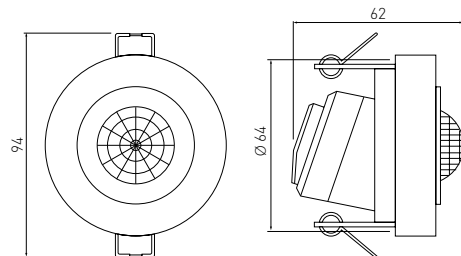

AE-CM1500-00	Plastique, plastico, Kunststoff, plastika	blanc, blanco, weiß, bijeli	103 g	5902801002519



Elektro-  
installationsausrüstung

FR Détecteur de mouvement à micro-ondes  
 ES Detector de movimiento por microondas  
 DE Mikrowellenbewegungssensor  
 HR Senzor pokreta mikrovalni

## SRC812-MINI

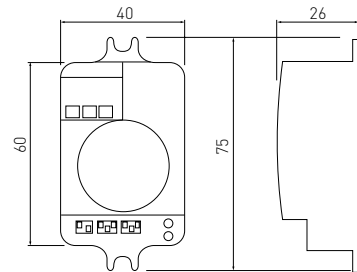

AE-SRC812-MIN	Plastique, plastico, Kunststoff, plastika	blanc, blanco, weiß, bijeli	45 g	5901867124326



FR Détecteur de mouvement à micro-ondes  
 ES Detector de movimiento por microondas  
 DE Mikrowellenbewegungssensor  
 HR Senzor pokreta mikrovalni

## SRC812-MINI2

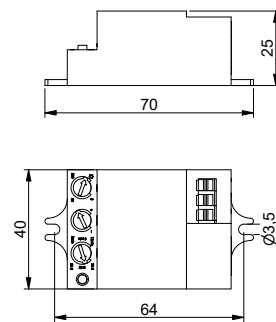

AE-SRC812-MIN2	PC	blanc, blanco, weiß, bijeli	40 g	5902801282133





FR Détecteur de mouvement à micro-ondes  
 ES Detector de movimiento por microondas  
 DE Mikrowellenbewegungssensor  
 HR Senzor pokreta mikrovalni

## SRC812

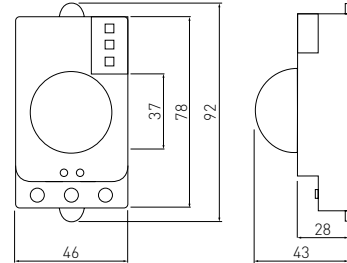

AE-SRC812-00

Plastique, plastico, Kunststoff, plastika

blanc, blanco, weiß, bijeli

70 g

5908231303738



FR Capteur crépusculaire  
 ES Detector crepuscular  
 DE Dämmerungssensor  
 HR Senzor nivoa osvjetljenosti (luksomat)

## CZ-1

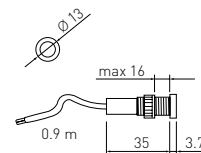
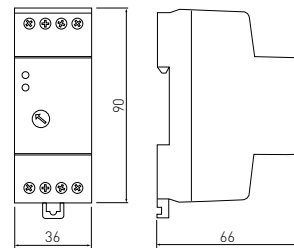

CZ-CZ1000-00

Plastique, plastico, Kunststoff, plastika

blanc, blanco, weiß, bijeli

130 g

5901867108920



FR Capteur crépusculaire  
 ES Detector crepuscular  
 DE Dämmerungssensor  
 HR Senzor nivoa osvjetljenosti (luksomat)

**MAX**  
4800 W

**5**  
years  
warranty

**CZ-2**

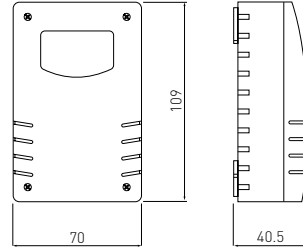

CZ-CZ2000-00	Plastique, plastico, Kunststoff, plastika	blanc, blanco, weiß, bijeli	130 g	5901867108937
--------------	---	-----------------------------	-------	---------------

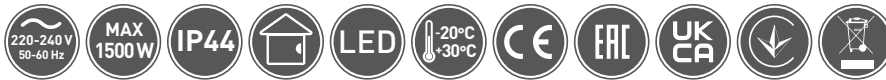

FR Horloge programmable mécanique 24 h  
 ES Programador de tiempo mecánico, 24 h  
 DE Mechanische Zeitschaltuhr 24 h  
 HR Mehanički timer 24 sata



PC-MECH24-00

PC-MECH24-SC

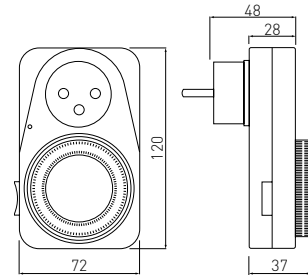

PC-MECH24-00	Plastique, plastico, Kunststoff, plastika	blanc, blanco, weiß, bijeli	140 g	5908231327215
PC-MECH24-SC				5908231351104



FR Horloge programmable électronique 7 jours 24 h  
 ES Programador de tiempo electrónico, 7 días, 24 h  
 DE Elektronische 7 Tage/24 h Zeitschaltuhr  
 HR Elektronički timer 7 dana 24 sata

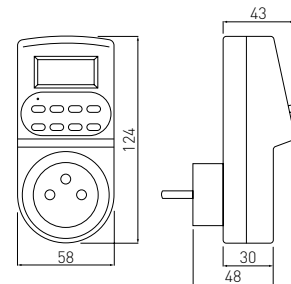

PC-ELE724-00	Plastique, plastico, Kunststoff, plastika	blanc, blanco, weiß, bijeli	150 g	5908231327208
PC-ELE724-SC				5908231351128





FR Rallonge de maison  
ES Alargador doméstico  
DE Steckdosenverlängerungskabel  
HR Kućni produžni kabel



	 m	X		
AE-PS3G3M-00	3 m	3	H05VV-F 3x1.5 mm <sup>2</sup>	5908231301192
AE-PS3G5M-00	5 m			5908231301208
AE-PS4G3M-00	3 m	4		5908231301215
AE-PS4G5M-00	5 m			5908231301222
AE-PS5G3M-00	3 m	5		5908231301239
AE-PS5G5M-00	5 m			5908231301246



FR Rallonge de maison  
ES Alargador doméstico  
DE Steckdosenverlängerungskabel  
HR Kućni produžni kabel



	 m	X		
AE-PF3G1M-00	1,5 m	3	H05VV-F 3G1.0 mm <sup>2</sup>	5901867170057
AE-PF3G3M-00	3 m			5901867170033
AE-PF3G5M-00	5 m	5		5901867170040
AE-PF5G3M-00	3 m			5901867170064
AE-PF5G5M-00	5 m			5901867170071



FR Rallonge à tambour (schuko)  
 ES Prolongador enrollable (schuko)  
 DE Trommelverlängerungskabel (schuko)  
 HR Produžni kabel na bubnju (schuko)



AE-SBEBEN-30	30 m	4	3 x 1,5 mm <sup>2</sup>	Plastique + acier, plastico + acero, Kunststoff + Stahl, plastika + čelik	noir, negro, schwarz, crna	5908231322722
AE-SBEBEN-50	50 m					5908231322739



FR Rallonge à tambour avec interrupteur thermique  
 ES Prolongador enrollable con interruptor térmico  
 DE Trommelverlängerungskabel mit einem Thermoschalter  
 HR Produžni kabel na bubnju s toplinskim prekidačem



AE-PFBEBEN-20	20 m	4	3 x 1 mm <sup>2</sup>	Plastique + acier, plastico + acero, Kunststoff + Stahl, plastika + čelik	noir, negro, schwarz, crna	5901867170088
AE-PFBEBEN-40	40 m					5901867170095



FR Rallonge de jardin  
ES Cable de extensión para jardín  
DE Gartenverlängerungskabel  
HR Vrtni produžni kabel



AE-POGRODUN-10	10 m	2 x 1,0 mm <sup>2</sup>	orange, naranja, orange, naranča	5901867163387
AE-POGRODUN-20	20 m			5901867163394
AE-POGRODUN-30	30 m			5901867163400



FR Douille pour lampes  
ES Toma para casquillo  
DE Leuchtmittel-Fassung  
HR Grlo



GZ-GZ10-0000	blanc, blanco, weiß, bijeli	5908231305756
GZ-MR16-0000*		5908231331656





FR Douille pour lampes  
ES Toma para casquillo  
DE Fassungen für Lampen  
HR Grlo

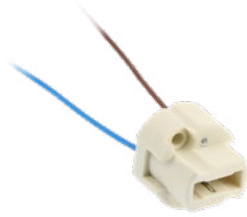

GZ-G90000-00

blanc, blanco, weiß, bijeli

5902801222665



FR Multiprise avec mise à la terre  
ES Ladrón con toma de tierra, multiples tomas  
DE Steckverteiler mit Erdung  
HR Razdjelnik s uzemljenjem



INFO



AE-RU0121-00

2 + 1 sur 1, 2 + 1 en 1, 2 + 1 auf 1, 2 + 1 na 1

5908231301260



FR Multiprise avec mise à la terre  
ES Ladrón con toma de tierra 2 entradas  
DE Steckverteiler mit Erdung  
HR Razdjelnik s uzemljenjem



INFO



AE-RU0102-00

1 sur 2, 1 en 2, 1 auf 2, 1 na 2

5908231301253



FR Multiprise avec mise à la terre  
 ES Ladrón con toma de tierra 2 entradas  
 DE Steckverteiler mit Erdung  
 HR Razdjelnik s uzemljenjem



AE-SC0102-00	blanc, blanco, weiß, bijeli	5908231360847
--------------	-----------------------------	---------------



FR Multiprise avec mise à la terre  
 ES Ladrón con toma de tierra 3 entradas  
 DE Steckverteiler mit Erdung  
 HR Razdjelnik s uzemljenjem



INFO



AE-SC0103-00	1 sur 3, 1 en 3, 1 auf 3, 1 na 3	5908231360854
--------------	----------------------------------	---------------



FR Fiche de réseau plate angulaire  
 ES Enchufe plano angular  
 DE Flacher Winkelstecker  
 HR Plosnati kutni utikač



White

Black



INFO



AE-VA1UNI-00	blanc, blanco, weiß, bijeli	5901867171887
AE-VA1UNI-10	noir, negro, schwarz, crna	5902801318849



FR Multiprise avec mise à la terre  
 ES Ladrón con toma de tierra 3 entradas  
 DE Steckverteiler mit Erdung  
 HR Razdjelnik s uzemljenjem



16 A



INFO



AE-RU0103-00

1 sur 3, 1 en 3, 1 auf 3, 1 na 3

5908231301277



FR Douille céramique  
 ES Toma cerámica para casquillos  
 DE Keramiksocket  
 HR Keramičko grlo E27

MAX  
100 W



AE-OCEF27-00

blanc, blanco, weiß, bijeli

5908231302120



FR Douille céramique  
 ES Toma cerámica para casquillos  
 DE Keramiksocket  
 HR Keramičko grlo E14

MAX  
100 W



AE-OCEE14-00

blanc, blanco, weiß, bijeli

5908231302090





FR Douille céramique  
 ES Toma cerámica para casquillos  
 DE Keramische Fassung  
 HR Keramičko grlo E27



MAX  
100 W



AE-OCEE27-00

blanc, blanco, weiß, bijeli

5908231302106



FR Douille céramique  
 ES Toma cerámica para casquillos  
 DE Keramische Fassung  
 HR Keramičko grlo E27



MAX  
100 W



AE-OCEE27-MM

blanc, blanco, weiß, bijeli

5902801340048



FR Douille céramique  
 ES Toma cerámica para casquillos  
 DE Keramische Fassung  
 HR Keramičko grlo E27



MAX  
100 W



AE-OCEE40-00

blanc, blanco, weiß, bijeli

5902801227271



FR Douille  
ES Luminaria  
DE Aufbauleuchte  
HR Rasvjetno tijelo



MAX  
100 W



AE-OPE27P-00

blanc, blanco, weiß, bijeli

5901867143327



FR Douille pour lampes E27  
ES Toma para casquillo E27  
DE Fassungen für Lampen E27  
HR Grlo E27



MAX  
60 W



GZ-E27000-10

noir, negro, schwarz, crna

5902801292620

GZ-E27000-00

blanc, blanco, weiß, bijeli

5902801256226



FR Douille d'adaptation  
ES Adaptador  
DE Leuchtmittel-Adapter  
HR Adapter



MAX  
50 W



INFO



AE-E14GU10-00

E14, GU10

blanc, blanco, weiß, bijeli

5908231391797



MAX  
50 W

FR Douille d'adaptation  
ES Adaptador  
DE Leuchtmittel-Adapter  
HR Adapter



5  
years  
warranty



INFO



AE-E14E27-00	E14, E27	blanc, blanco, weiß, bijeli	5901867112156
--------------	----------	-----------------------------	---------------



FR Douille d'adaptation  
ES Adaptador  
DE Leuchtmittel-Adapter  
HR Adapter

MAX  
50 W



5  
years  
warranty



INFO



AE-E27E14-00	E27, E14	blanc, blanco, weiß, bijeli	5908231391780
--------------	----------	-----------------------------	---------------



FR Douille d'adaptation  
ES Adaptador  
DE Leuchtmittel-Adapter  
HR Adapter

MAX  
50 W



5  
years  
warranty



INFO



AE-27GU10-00	E27, GU10	blanc, blanco, weiß, bijeli	5908231391803
--------------	-----------	-----------------------------	---------------



FR Douille d'adaptation  
ES Adaptador  
DE Leuchtmittel-Adapter  
HR Adapter



INFO



AE-GU10E27-00	GU10, E27	blanc, blanco, weiß, bijeli	5908231302540
---------------	-----------	-----------------------------	---------------



FR Douille d'adaptation  
ES Adaptador  
DE Leuchtmittel-Adapter  
HR Adapter



INFO



AE-E40E27-00	E40, E27	blanc, blanco, weiß, bijeli	5901867124227
--------------	----------	-----------------------------	---------------



FR Anneau pour douilles E14, E27  
ES Anillo para tomas E14, E27  
DE Befestigungsring  
HR Prsten za grla E14, E27



INFO



AE-E27RING-10	E27	blanc, blanco, weiß, bijeli	5901867124221
AE-E14RING-10	E14		5901867124227

Elektro-  
installationsausrüstung





FR Raccord en imperméable, serre-fils de fixation  
 ES Adaptador impermeable, conector para cables eléctricos  
 DE Wasserdichter Verbinder für elektrische Kabel  
 HR Vodonepropusni konektor



WZL-2	Plastique, plastico, Kunststoff, plastika	noir, negro, schwarz, crna	5901867122070
-------	---	----------------------------	---------------



FR Raccord en T imperméable, serre-fils de fixation  
 ES Adaptador T impermeable, conector para cables eléctricos  
 DE Wasserdichtes T-Stück für Elektroleitungen  
 HR Vodonepropusni konektor



WZL-3	Plastique, plastico, Kunststoff, plastika	noir, negro, schwarz, crna	5901867122094
-------	---	----------------------------	---------------



FR Raccord en T imperméable, serre-fils de fixation  
 ES Adaptador T impermeable, conector para cables eléctricos  
 DE Wasserdichtes T-Stück für Elektroleitungen  
 HR Vodonepropusni konektor



WZL-4	Plastique, plastico, Kunststoff, plastika	noir, negro, schwarz, crna	5902801016189
-------	---	----------------------------	---------------



FR Connecteur avec un revêtement isolant pour luminaires  
 ES Bloque de conexión con cubierta de aislamiento para luminarias  
 DE Isolierte Kabelsteckklemme für Leuchten  
 HR Redna stezaljka s kutijom



LZ-KOI2KO-10	noir, negro, schwarz, crna	5901867199027
--------------	----------------------------	---------------



FR Raccord à compression, élastique  
 ES Conector de presión, elástico  
 DE Lüsterklemmen - flexibel  
 HR Redna stezaljka fleksibilna

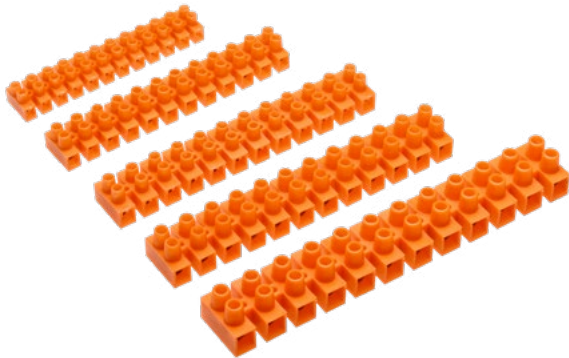
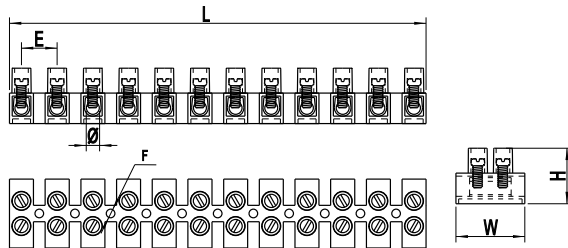

L (mm) W (mm) H (mm) E (mm) F (mm) Ø (mm)

	L (mm)	W (mm)	H (mm)	E (mm)	F (mm)	Ø (mm)
LZ-25MM00-00	93,5	16,8	12,3	8	2,5	3
LZ-40MM00-00	114,9	18,9	15,3	9,9	2,7	3,2
LZ-60MM00-00	129,1	20,7	16,5	11	3,1	4,2
LZ-100MM00-00	137,5	22,5	18,2	11,8	3,1	4,5
LZ-160MM00-00	164,5	25,5	20	14,1	3,4	5,5
LZ-250MM00-00	187,6	29,3	25,3	16	3,4	6,5



	(A)				
LZ-25MM00-00	3 A	Polyéthylène, polietylen, Polyethylen, polietilen	16 g	10	5908231331922
LZ-40MM00-00	6 A		26 g		5908231331939
LZ-60MM00-00	10 A		32 g		5908231331946
LZ-100MM00-00	15 A		46 g		5908231331892
LZ-160MM00-00	30 A		65 g		5908231331908
LZ-250MM00-00	60 A		96 g		5908231331915





FR Protection de plafond pour connecteur électrique  
 ES Cubierta de techo para bloque de conexión  
 DE Deckenabdeckung für den Anschlußwürfel  
 HR Stropni poklopac za električnu kocku



White

Black

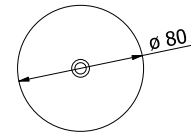

AE-MA8028-10	Metall, Metall, Metall, metal	blanc, blanco, weiß, bijeli	109 g	5902801336546
AE-MA8028-00		noir, negro, schwarz, crna		5902801336553

FR Cache plafond pour bloc de connexion  
 ES Cubierta de techo para bloque de conexión  
 DE Deckenabdeckung für den Anschlußwürfel  
 HR Stropni poklopac



White

Black

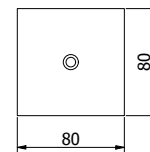

AE-MAS80X80-10	Plastique, plastico, Kunststoff, plastika	blanc, blanco, weiß, bijeli	90 g	5902801245091
AE-MAS80X80-00		noir, negro, schwarz, crna		5902801244742



FR Cache plafond pour bloc de connexion  
 ES Cubierta de techo para bloque de conexión  
 DE Deckenschutzverkleidung für Kabelsteckklemme  
 HR Stropni poklopac



AE-CANOPY-10	blanc, blanco, weiß, bijeli	5901867124234
--------------	-----------------------------	---------------

FR Trépied pour luminaires halogènes, LED  
 ES Soporte para luminarias halógenas, led  
 DE Ständer für Halogen- und LED-Lampen  
 HR Stativ za reflektore

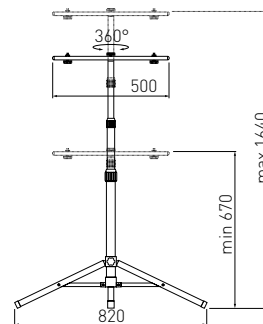

OH-ST2500-23	Acier, acero, Stahl, želik	Jaune, amarillo, gelb, žuti	2000 g	5908231360663
--------------	----------------------------	-----------------------------	--------	---------------

Elektro-  
installationsausrüstung







FR Câble d'alimentation 2 m avec prise et interrupteur  
 ES Cable de alimentación de 2 m con enchufe e interruptor  
 DE Kabel mit Stecker und Schalter, 2 m  
 HR Napajacki kabel 2 m s utikačem i prekidačem



LD-KABE2M-00

LD-KABE2M-10



LD-KABE2M-00	2 m	5908231335265
LD-KABE2M-10		5902801004018



FR Câbles avec fiche  
 ES Cables con enchufe  
 DE Kabel mit Stecker  
 HR Kabeli s utikačem



KB-W310HUG-20	1,5 m	5908231385871
KB-W313HUG-20	3 m	5902801003899



FR Starter  
 ES Encendedor  
 DE Starter  
 HR Starter



INFO



OS-STA422-00	4-22 W, 230 V AC	5908231332578
OS-STA465-00	4-65 W, 230 V AC	5908231332585



FR Ballasts électroniques  
ES Fuentes de alimentación  
DE Elektronisches Vorschaltgerät  
HR Elektronske prigušnice

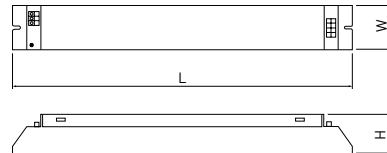

				LxWxH	
OS-SEL236-ZHQ	2 x 36 W / T8	70 g	Metall, Metall, Metall, metal	320 x 32 x 28 mm	5902801038174
OS-SEL418-ZHQ	4 x 18 W / T8	78 g			5902801038167



FR Ballasts électroniques  
ES Fuentes de alimentación  
DE Elektronisches Vorschaltgerät  
HR Elektronske prigušnice

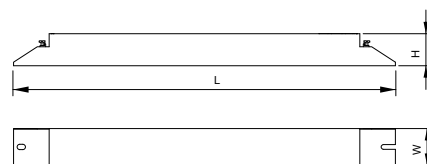

				LxWxH	
OS-NSEL158-00	58 W / T8	250 g	Metall, Metall, Metall, metal	271 x 27 x 27 mm	5902801281266
OS-NSEL136-00	36 W / T8	200 g			5902801281655
OS-NSEL118-00	18 W / T8	180 g			5902801218729



FR Alimentation DALI  
ES Alimentador DALI  
DE Transformator DALI  
HR Napajanje DALI

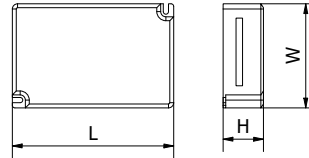

	CC	U OUTPUT	LxWxH mm		
BK-PUL030A-0700AD	250-700 mA	3-42V	104 x 68 x 31	170 g	5902801299377
BK-PUL042A-0700BD	250-700 mA	3-84V	104 x 68 x 21		5902801299483
BK-PUL042A-1100AD	600-1100 mA	3-42V	104 x 68 x 21		5902801299452
BK-PUL060A-2000AD	800-2000 mA	3-42V	124 x 80 x 31		5902801270758



FR Alimentation DALI  
ES Alimentador DALI  
DE Transformator DALI  
HR Napajanje DALI

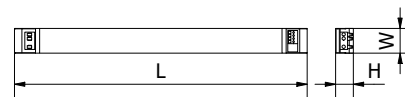

	CC	U OUTPUT	LxWxH mm		
BK-BHL050-1000BZ	550-1000 mA	3-54V	355 x 30 x 21	300 g	5902801270741
BK-BHL060-1300BZ	850-1300 mA		285 x 30 x 21		5902801299537



Elektro-  
installationsausrüstung



FR Module d'urgence pour panneaux LED  
 ES Módulo de emergencia para paneles LED  
 DE Notfallmodul für LED-Panele  
 HR Panik modul za LED panele

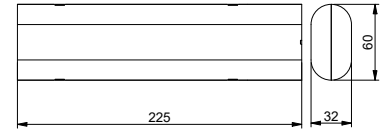

OA-MALEDPAN-00	3 h	PC	blanc, blanco, weiß, bijeli	525 g	5902801285400





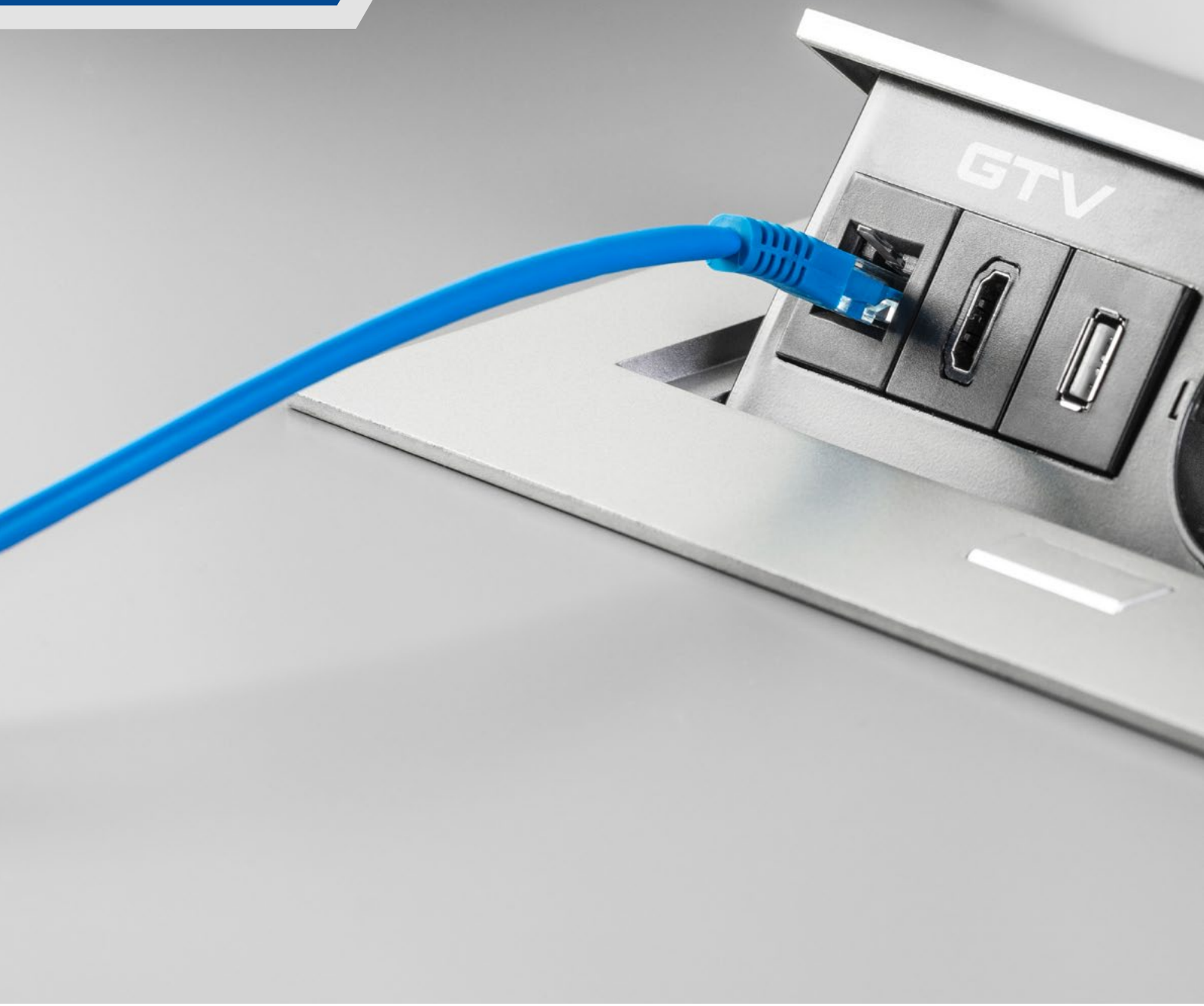



ÉCLAIRAGE DE MEUBLES / PROFILS LED  
ILUMINACIÓN PARA MUEBLES / PERFILES LED  
MÖBEL BELEUCHTUNG  
RASVJETA ZA NAMJEŠTAJ / LED PROFILI

Rubans LED / Profils LED  
Tiras de LED / Perfiles LED  
LED-Band / LED-profile  
LED trake / LED profili ..... 401

Luminaire LED  
Luminaria LED  
LED-Leuchte  
LED svjetiljke ..... 438

Accessoires  
Accesorios  
Zubehör  
Dodatna oprema ..... 446

Rallonge  
Alargadera  
Verlängerungskabel  
Utičnice ..... 475



RUBANS LED / PROFILS LED  
TIRAS DE LED / PERFILES LED  
LED-BAND / LED-PROFILE  
LED TRAKE / LED PROFILI



Easy-Click-Set in 5 Schritten vervollständigen  
Complétez le kit easy click en cinq pas  
Completa el set EASY CLICK en 5 pasos  
Sastavite EASY CLICK set u 5 koraka



1.

Wählen Sie LED Streifen  
choisissez une bande  
elige la tira LED  
odabir LED trake

Wählen Sie die Anzahl der Abschnitte der LED-Streifen  
sélectionnez le nombre de section de ruban LED  
selecciona el número de secciones de tiras LED  
odaberite broj dijelova LED trake

2.

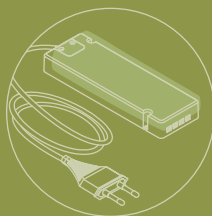

3.

passender Transformator  
alimentation adaptée  
fuente de alimentación  
correspondiente  
uskladite napajanje

wählen Sie das Profil. Profile werden als fertig  
konfektionierte 2-Meter-Sets verkauft, inklusive  
Profil, Abdeckung und 2 Blenden  
choisissez un profil les profilés sont vendues sous  
forme d'un kit prêt de 2 m incluant un profil,  
un diffuseur et 2 bouchons d'extrémité"  
elige un perfil

Los perfiles se venden en sets de 2m que incluyen  
un perfil, un difusor y dos tapas"  
odaberite profil , profili se prodaju kao gotovi setovi  
od 2 m koji sadrže profil, poklopac i 2 završne kape

4.

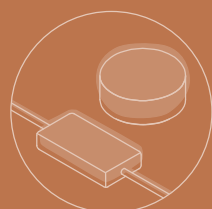
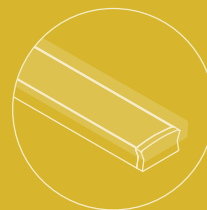

5.

wählen Sie den Schalter  
choisissez un interrupteur  
elige el interruptor  
odaberite sklopku

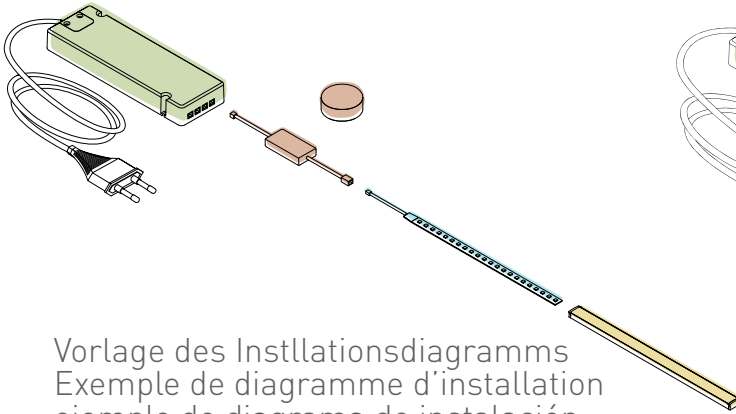



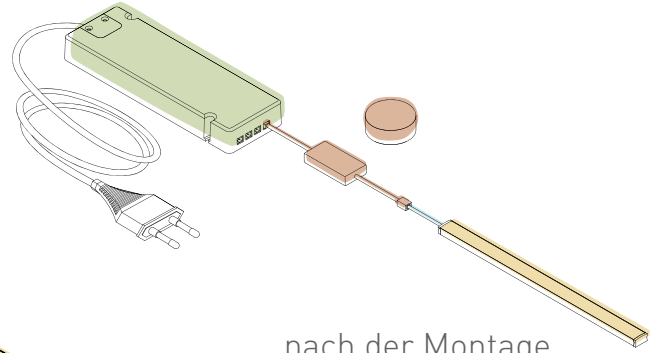

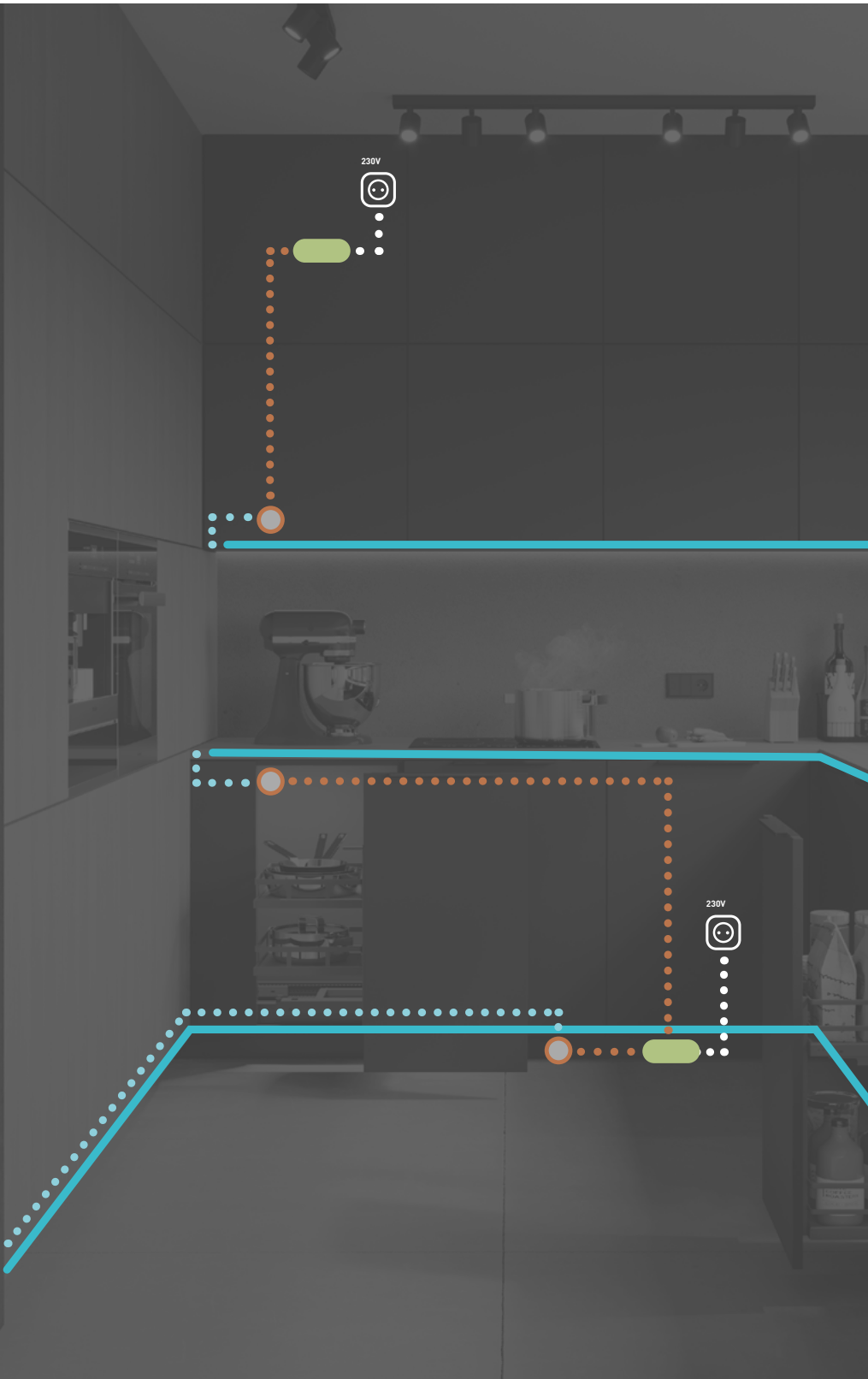

Vorlage des Instllationsdiagramms  
Exemple de diagramme d'installation  
ejemplo de diagrama de instalación  
prije montaže



nach der Montage  
après l'assemblage  
después del montaje  
poslije montaže



-  LED-Streifen im Profil  
Ruban LED dans le profil  
tira LED en un perfil  
LED traka u profilu
-  Kabel vom LED-Streifen zum Schalter  
Câble du ruban LED au interrupteur  
cable de la tira LED al interruptor  
Kabel od LED trake do sklopke
-  Kabel des Schalters  
Câbles de l'interrupteur  
cables del interruptor  
Zamjente kablove
-  Kabel von der 230-V-Steckdose zum Transformator  
Câble de prise électrique 230 V à l'alimentation  
Cable de la toma de corriente de 230 V a la fuente de alimentación  
Kabel od 230V mrežne utičnice do LED transformatora
-  schalten  
interrupteur  
cambiar  
sklopka
-  Transformator  
alimentation  
fuente de alimentación LED  
LED transformator





LD-3528-300-20-ZB	12 VDC 4,8 W/1 m 17 W/5 m	300 lm/m	● 6500 K	20	120°	8	60/m	5	5901867152053
LD-3528-300-20-NE4P			● 4000 K						5902801224911
LD-3528-300-20-CB			● 3200 K						5901867152022
LD-3528-300-65-ZB		280 lm/m	● 6500 K	5901867152114					
LD-3528-300-65-NE4			● 4000 K	5902801370632					
LD-3528-300-65-CB			● 3200 K	5901867152084					
LD-3528-300-20-NI	-	bleu, azul, blau, plava		5901867198983					
LD-3528-600-20-ZB	12 VDC 9,6 W/1 m 28 W/5 m	550 lm/m	● 6500 K	20		8	120/m	2,5	5901867152251
LD-3528-600-20-NE4			● 4000 K						5902801370465
LD-3528-600-20-CB			● 3200 K						5901867152312
LD-3528-600-65-ZB		520 lm/m	● 6500 K	5901867152374					
LD-3528-600-65-NE4			● 4000 K	5902801370625					
LD-3528-600-65-CB			● 3200 K	5901867152343					
LD-2835-300-20-ZB	12 VDC 6 W/1 m 21 W/5 m	750 lm/m	● 6500 K	20	8	60/m	5	5901867152640	
LD-2835-300-20-NE4P			● 4000 K					5902801224980	
LD-2835-300-20-CB			● 3200 K					5901867152619	
LD-2835-300-65-ZB		700 lm/m	● 6500 K	5901867152701					
LD-2835-300-65-NE4			● 4000 K	5902801295386					
LD-2835-300-65-CB			● 3200 K	5901867152671					
LD-2835-300-20-CBN	12 VDC 11 W/1 m 33 W/5 m	1000 lm/m	● 3200 K	20		8	120	5	5902801285585
LD-2835-300-20-ZBN			● 6500 K						5902801285530
LD-2835-300-20-NE4N			● 4000 K						5902801285738
LD-2835-300-65-CBN		900 lm/m	● 3200 K	5902801294785					
LD-2835-300-65-ZBN			● 6500 K	5902801285707					
LD-2835-300-65-NE4N			● 4000 K	5902801295386					
LD-2835-600-20-ZB	12 VDC 19 W/1 m 60 W/5 m	1600 lm/m	● 6500 K	20	10	120/m	2,5	5902801231933	
LD-2835-600-20-NE4			● 4000 K					5902801268700	
LD-2835-600-20-CB			● 3200 K					5902801231537	
LD-2835-600-65-ZB		1350 lm/m	● 6500 K	5902801231605					
LD-2835-600-65-NE4			● 4000 K	5902801370519					
LD-2835-600-65-CB			● 3200 K	5902801231360					





LD-2835-600-5MM-20-ZB	12 VDC 10 W/1 m 33 W/5 m	750 lm/m	● 6500 K	20	120°	5	120/m	2,5	5902801285448
LD-2835-600-5MM-20-NE4			● 4000 K						5902801285547
LD-2835-600-5MM-20-CB			● 3200 K						5902801285486
LD-2835-60-60-20-CCT	12 VDC 10 W/1 m 30 W/5 m	700 lm/m	● 3200 K ● 6500 K	20		8		5	5902801260292
LD-5050-300-20-ZB	12 VDC 14,4 W/1 m 44 W/5 m	900 lm/m	● 6500 K	65	120°	10	60/m	5	5901867152497
LD-5050-300-20-NE4			● 4000 K						5902801370717
LD-5050-300-20-CB			● 3200 K						5901867152466
LD-5050-300-65-ZB	12 VDC 14,4 W/1 m 44 W/5 m	850 lm/m	● 6500 K	65	120°	10	60/m	5	5901867152558
LD-5050-300-65-NE4			● 4000 K						5902801370502
LD-5050-300-65-CB			● 3200 K						5901867152527
LD-5630-300-20-ZB	12 VDC 16 W/1 m 50 W/5 m	1750 lm/m	● 6500 K	20	120°	10	60/m	5	5901867152763
LD-5630-300-20-NE4			● 4000 K						5902801358012
LD-5630-300-20-CB			● 3200 K						5901867152732
LD-5630-300-65-ZB	12 VDC 16 W/1 m 50 W/5 m	1700 lm/m	● 6500 K	65	120°	10	60/m	5	5901867152824
LD-5630-300-65-NE4			● 4000 K						5902801358036
LD-5630-300-65-CB			● 3200 K						5901867152794
LD-3014-1200-20-ZB	12 VDC 19 W/1 m 53 W/5 m	1300 lm/m	● 6500 K	20	120°	10	240/m	1,25	5902801231766
LD-3014-1200-20-NE4			● 4000 K						5902801232077
LD-3014-1200-20-CB			● 3200 K						5902801267154
LD-RGB-150-20	12 VDC max 7,2 W/1 m 22 W/5 m	-	● RGB	65	120°	10	30/m	10	5901867152404
LD-RGB-150-65			● RGB						5901867152435
LD-RGBW-300-20	12 VDC max 17 W/1 m	-	● RGBW	20			120°	10	60/m





FR Ruban LED FLASH 50 m  
 ES Tira LED FLASH 50 m  
 DE LED-Band FLASH 50 m  
 HR LED traka FLASH 50 m



LD-3528-300-20-ZB-50	12 VDC 4,8 W/m	300 lm/m	● 6500 K	20	120°		60/m	5	5901867172099			
LD-3528-300-20-NE4P-50			● 4000 K						5902801252150			
LD-3528-300-20-CB-50			● 3200 K						5901867172082			
LD-3528-600-20-ZB-50	12 VDC 9,6 W/m	550 lm/m	● 6500 K			8 mm	120/m		5902801370564			
LD-3528-600-20-NE4-50			● 4000 K						5902801370403			
LD-3528-600-20-CB-50			● 3200 K						5902801370601			
LD-2835-300-20-ZB-50	12 VDC 6 W/m	750 lm/m	● 6500 K			20	120°			60/m	5	5901867195142
LD-2835-300-20-NE4P-50			● 4000 K									5902801225000
LD-2835-300-20-CB-50			● 3200 K									5901867195128
LD-5050-300-20-NE4-50	12DC 14,4W/m	900 lm/m	● 4000 K						10 mm			
LD-5630-300-20-NE4-50	12DC 16W/m	1750 lm/m	● 4000 K							5902801358470		



FR Ruban LED FLASH  
ES Tira LED FLASH  
DE LED-Band FLASH  
HR LED traka FLASH



LD-2835-24V-300-20-ZB	24 V DC 12 W/1 m 48 W/5 m	780 lm/m	6500 K	20	120°	8 mm	60/m	10	5902801245664
LD-2835-24V-300-20-NE4			4000 K						5902801245787
LD-2835-24V-300-20-CB			3200 K						5902801245633
LD-2835-24V-600-20-ZB	24 V DC 21 W/1 m 78 W/5 m	1350 lm/m	6500 K	20	120°	10 mm	120/m	5	5902801245701
LD-2835-24V-600-20-NE4			4000 K						5902801245640
LD-2835-24V-600-20-CB			3200 K						5902801245855



FR Kit RGB, ruban LED 5 m, contrôleur, alimentation, télécommande  
ES Kit RGB, tira LED 5 m, controlador, alimentador, control a distancia  
DE RGB-Set, LED-Band 5m, Steuergerät, Netzteil, Fernbedienung  
HR RGB set, LED traka 5m, kontroler, napajanje, daljinski upravljač

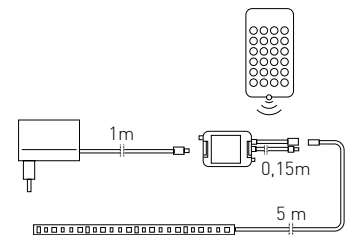

LD-ZL5RGB150-00		12V	RGB	Plastique, plastico, Kunststoff, plastika	10	10	5902801025839



FR Ruban LED COB  
ES Tira LED COB  
DE LED-Band COB  
HR LED traka COB

**NEW**



Folder	W	Light	Color	IP	Beam	mm	LED	cm	Barcode
LD-COB12V-20-ZBN	12V, 8W/m	600 lm/m	6500 K	20	180	8	320/m	2.5	5902801364129
LD-COB12V-20-CBN		600 lm/m	2700 K						5902801363955
LD-COB12V-20-NEN		700 lm/m	4000 K						5902801363993
LD-COB12V-20-ZBPQ	12V, 10W/m	800 lm/m	6500 K				480/m		5902801364198
LD-COB12V-20-CBPQ		750 lm/m	2700 K						5902801363870
LD-COB12V-20-NEPQ		800 lm/m	4000 K						5902801364228



FR Ruban LED COB  
ES Tira LED COB  
DE LED-Band COB  
HR LED traka COB

**NEW**



Folder	W	Light	Color	IP	Beam	mm	LED	cm	Barcode
LD-COB24V-20-ZBN	24V, 8W/m	650 lm/m	6500 K	20	180	8	320/m	2.5	5902801423666
LD-COB24V-20-CBN		600 lm/m	2700 K						5902801424090
LD-COB24V-20-NEN		600 lm/m	4000 K						5902801424083



FR Ruban LED NEON FLEX  
ES Tira LED NEON FLEX  
DE LED-Band NEON FLEX  
HR LED traka NEON FLEX



LD-NF-12V6x12-65-ZB	12 VDC 12 W/1 m 40 W/5 m	200 lm/m	● 6500 K	IP 65	120°	6 mm	x1	120/m	1 cm	5902801366857
LD-NF-12V6x12-65-NE			● 4000 K							5902801367106
LD-NF-12V6x12-65-CB			● 3000 K							5902801365973

LD-ZASNF-12V6X12-65	bouchon d'extrémité, tapa lateral, Endkappen, poklopac	5902801388705
LD-UNF-12V6X12-6X	clip de fixation, soporte, Montageclip, ručka	5902801388750

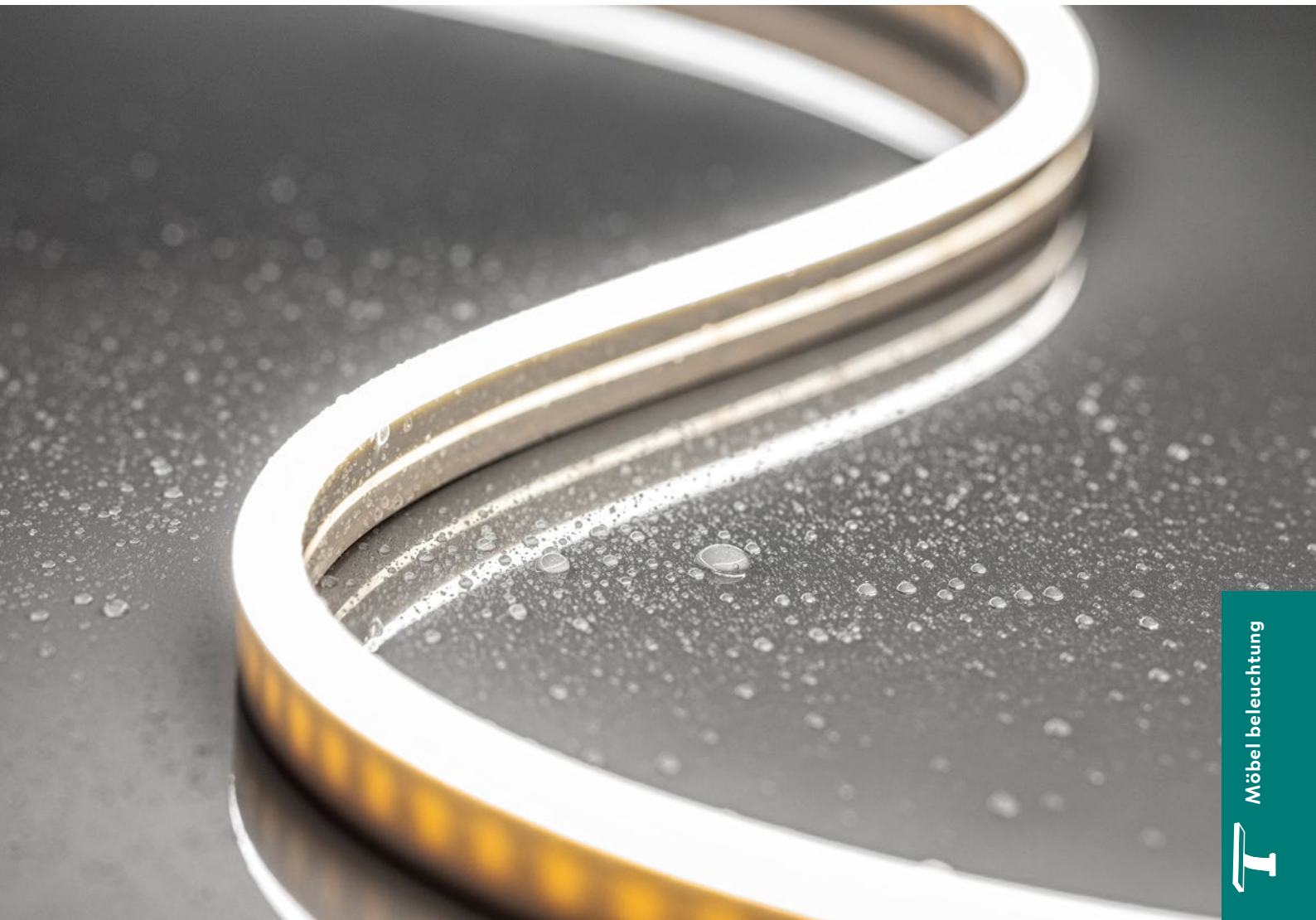



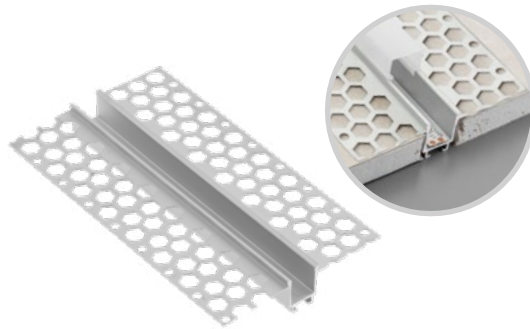

PA-GLAXGKL3M-00C	3	Profilé, Perfil, Profile, Profil	Argent, plata, silberfarben, srebrni	aluminium, aluminio, Aluminium, aluminij	5902801334429	
PA-CPGLAXL-00	-	connecteur linéaire, conector lineal, Stecker gerade, linijski priključak			Acier Inox, acero inoxidable, rostfreier Stahl, nehrđajući čelik	5902801295430
PA-CPGLAXAH-00	-	connecteur horizontal, conector horizontal, Anschluss horizontal, vodoravni priključak				5902801295300
PA-CPGLAXAV-00	-	connecteur verical, conector vertical, Verbinder vertikal, okomiti priključak				5902801295317
PA-OSMLGLAXM3M-00	3	protection, difusor, Abdeckungen, poklopac	blanc dépoli, blanco mate, milchig, mliječni	PC	5902801024047	
PA-OSMLGLAXMK3M-00	3	protection carrée, difusor cuadrada, quadratische Abdeckung, četvrtasto crijevo			5902801273926	
PA-OSMLGLAXMO3M-00	3	protection ronde, difusor redonda, Abdeckung rund, okruglo crijevo			5902801274152	
PA-OSMLGLAXT3M-00	3	protection triangulaire, difusor triangular, dreieckige Abdeckung, trokutasto crijevo			5902801274084	
PA-OSCLGLAXM3M-00	3	protection mini, difusor mini, Abdeckung mini, mini poklopac	noir, negro, schwarz, crna		5902801395581	

Protection / difusor / Abdeckungen / poklopac:



Accessoires / Accesorios / Zubehör / Dodatna oprema

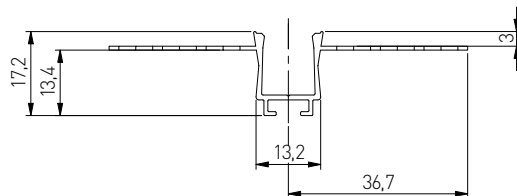





PA-GLAXGKS3M-00C	3	Profilé, Perfil, Profile, Profil	Argent, plata, silberfarben, srebrni	aluminium, aluminio, Aluminium, aluminij	5902801335204	
PA-CPGLAXL-00	-	connecteur linéaire, conector lineal, Stecker gerade, linijski priključak			Acier Inox, acero inoxidable, rostfreier Stahl, nehrdajući čelik	5902801295430
PA-CPGLAXAH-00	-	connecteur horizontal, conector horizontal, Anschluss horizontal, vodoravni priključak				5902801295300
PA-CPGLAXAV-00	-	connecteur vertical, conector vertical, Verbinder vertikal, okomiti priključak				5902801295317
PA-OSMLGLAXM3M-00	3	protection, difusor, Abdeckungen, poklopac	blanc dépoli, blanco mate, milchig, mliječni	PC	5902801024047	
PA-OSMLGLAXMK3M-00	3	protection carrée, difusor cuadrada, quadratische Abdeckung, četvrtasto crijevo			5902801273926	
PA-OSMLGLAXMO3M-00	3	protection ronde, difusor redonda, Abdeckung rund, okruglo crijevo			5902801274152	
PA-OSMLGLAXT3M-00	3	protection triangulaire, difusor triangular, dreieckige Abdeckung, trokutasto crijevo			5902801274084	
PA-OSCLGLAXM3M-00	3	protection mini, difusor mini, Abdeckung mini, mini poklopac	noir, negro, schwarz, crna		5902801395581	

Protection / difusor / Abdeckungen / poklopac:



Accessoires / Accesorios / Zubehör / Dodatna oprema



PA-CPGLAXL-00



PA-CPGLAXAH-00



PA-CPGLAXAV-00

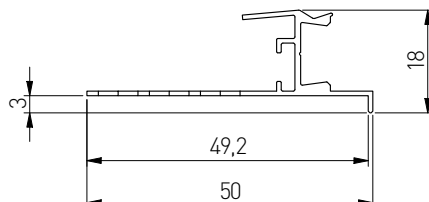





DO  
*something*  
(today)  
THAT YOUR  
FUTURE SELF  
will  
THANK YOU  
for.

BE  
BRAVE

Better  
days are  
coming.  
They're  
called  
Saturday and  
Sunday.

Smile  
you  
are  
beaut-  
iful.

the  
time  
is  
now.

DO  
WHAT  
YOU  
LOVE.





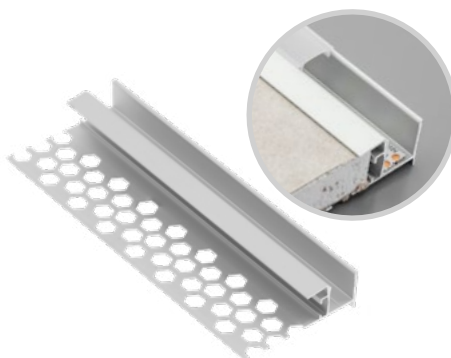

PA-GLAXGKW3M-00C	3	Profilé, Perfil, Profile, Profil	Argent, plata, silberfarben, srebrni	aluminium, aluminio, Aluminium, aluminij	5902801334641
PA-CPGLAXL-00	-	connecteur linéaire, conector lineal, Stecker gerade, linijski priključak		5902801295430	
PA-CPGLAXAH-00	-	connecteur horizontal, conector horizontal, Anschluss horizontal, vodoravni priključak		Acier Inox, acero inoxidable, rostfreier Stahl, nehrđajući čelik	5902801295300
PA-CPGLAXAV-00	-	connecteur vertical, conector vertical, Verbinder vertikal, okomiti priključak		5902801295317	
PA-OSMLGLAXM3M-00	3	protection, difusor, Abdeckungen, poklopac	blanc dépoli, blanco mate, milchig, mlječni	PC	5902801024047
PA-OSMLGLAXMK3M-00	3	protection carrée, difusor cuadrada, quadratische Abdeckung, četvrtasto crijevo			5902801273926
PA-OSMLGLAXMO3M-00	3	protection ronde, difusor redonda, Abdeckung rund, okruglo crijevo			5902801274152
PA-OSMLGLAXT3M-00	3	protection triangulaire, difusor triangular, dreieckige Abdeckung, trokutasto crijevo			5902801274084
PA-OSCLGLAXM3M-00	3	protection mini, difusor mini, Abdeckung mini, mini poklopac	noir, negro, schwarz, crna		5902801395581

Protection / Difusor / Abdeckungen / Poklopac:

Accessoires / Accesorios / Zubehör / Dodatna oprema



PA-OSMLGLAXM3M-00

PA-OSCLGLAXM3M-00

PA-OSMLGLAXMK3M-00

PA-OSMLGLAXMO3M-00

PA-OSMLGLAXT3M-00



PA-CPGLAXL-00



PA-CPGLAXAH-00



PA-CPGLAXAV-00

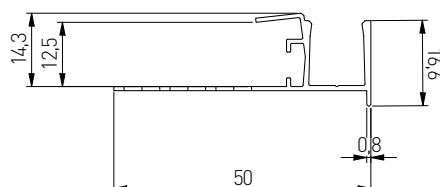





FR Profilé d'angle GLAX interne  
 ES Perfil GLAX angular, interno  
 DE Winkelprofil GLAX, innen  
 HR GLAX profil za gips kartonske ploče kutni unutarnji

**NEW**



**DOBRY WZÓR**  
2019

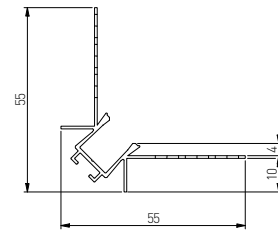
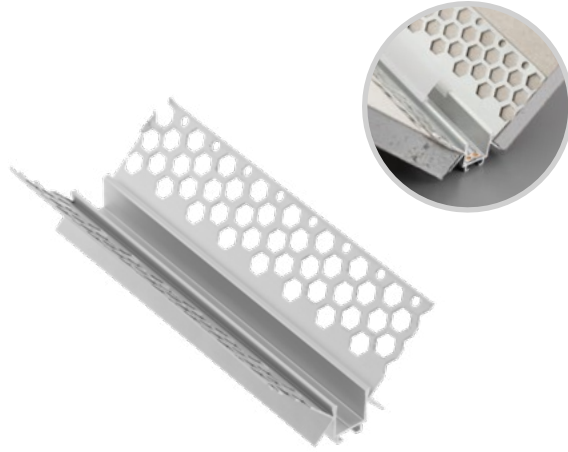

PA-GLAXGKWK3M-00C	3	Profilé, Perfil, Profile, Profil	Argent, plata, silberfarben, srebrni	aluminium, aluminio, Aluminium, aluminij	5902801334580	
PA-CPGLAXL-00	-	connecteur linéaire, conector lineal, Stecker gerade, linijski priključak			Acier Inox, acero inoxidable, rostfreier Stahl, nehrđajući čelik	5902801295430
PA-CPGLAXAH-00	-	connecteur horizontal, conector horizontal, Anschluss horizontal, vodoravni priključak				5902801295300
PA-CPGLAXAV-00	-	connecteur vertical, conector vertical, Verbinder vertikal, okomiti priključak				5902801295317
PA-OSMLGLAXM3M-00	3	protection, difusor, Abdeckungen, poklopac	blanc dépoli, blanco mate, milchig, mlječni	PC	5902801024047	
PA-OSMLGLAXMK3M-00	3	protection carrée, difusor cuadrada, quadratische Abdeckung, četvrtasto crijevo			5902801273926	
PA-OSMLGLAXMO3M-00	3	protection ronde, difusor redonda, Abdeckung rund, okruglo crijevo			5902801274152	
PA-OSMLGLAXT3M-00	3	protection triangulaire, difusor triangular, dreieckige Abdeckung, trokutasto crijevo			5902801274084	
PA-OSCLGLAXM3M-00	3	protection mini, difusor mini, Abdeckung mini, mini poklopac	noir, negro, schwarz, crna		5902801395581	

Protection / difusor / Abdeckungen / poklopac:

Accessoires / Accesorios / Zubehör / Dodatna oprema



FR Profilé d'angle GLAX externe  
 ES Perfil GLAX angular, externo  
 DE Winkelprofil GLAX, außen  
 HR GLAX profil za gips kartonske ploče kutni vanjski



**NEW**



**DOBRY WZÓR**  
2019

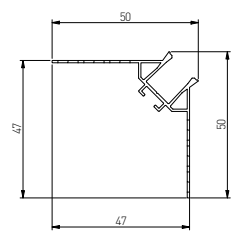
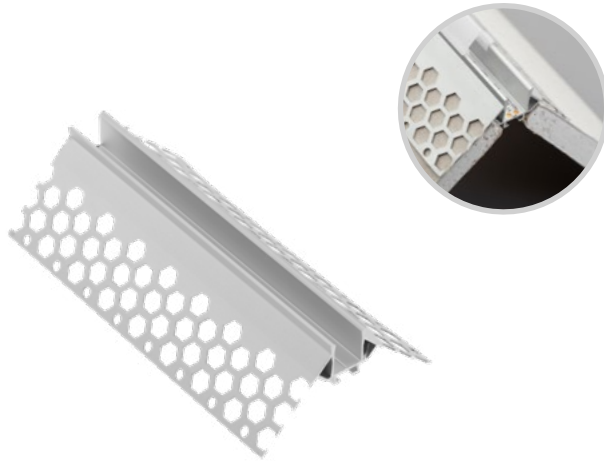

PA-GLAXGKZK3M-00C	3	Profilé, Perfil, Profile, Profil	Argent, plata, silberfarben, srebrni	aluminium, aluminio, Aluminium, aluminij	5902801334498
PA-CPGLAXL-00	-	connecteur linéaire, conector lineal, Stecker gerade, linijski priključak			5902801295430
PA-CPGLAXAH-00	-	connecteur horizontal, conector horizontal, Anschluss horizontal, vodoravni priključak			5902801295300
PA-CPGLAXAV-00	-	connecteur vertical, conector vertical, Verbinder vertikal, okomiti priključak			5902801295317
PA-OSMLGLAXM3M-00	3	protection, difusor, Abdeckungen, poklopac	blanc dépoli, blanco mate, milchig, mliječni	PC	5902801024047
PA-OSMLGLAXMK3M-00	3	protection carrée, difusor cuadrada, quadratische Abdeckung, četvrtasto crijevo			5902801273926
PA-OSMLGLAXMO3M-00	3	protection ronde, difusor redonda, Abdeckung rund, okruglo crijevo			5902801274152
PA-OSMLGLAXT3M-00	3	protection triangulaire, difusor triangular, dreieckige Abdeckung, trokutasto crijevo			5902801274084
PA-OSCLGLAXM3M-00	3	protection mini, difusor mini, Abdeckung mini, mini poklopac	noir, negro, schwarz, crna		5902801395581

Protection / difusor / Abdeckungen / poklopac:

Accessoires / Accesorios / Zubehör / Dodatna oprema





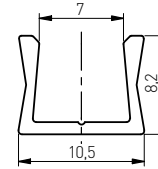
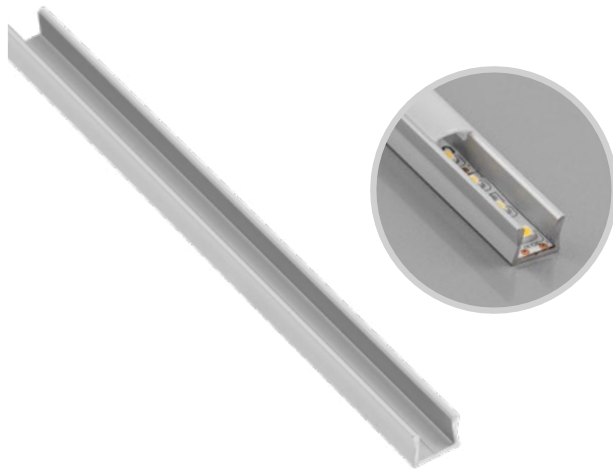

Ligne de lumière étroite,  
Aucun point d'éclairage lors de l'utilisation de la  
bande LED dédiée d'une largeur 5 mm  
Linea de luz delgada,  
Sin puntos de luz al utilizar  
una tira LED dedicada de anchura 5 mm

Schmale Lichtlinie. Keine Lichtpunkte bei Verwendung  
eines speziellen LED-Streifens mit einer Breite von 5 mm.

Uska linija svjetla,  
nema svjetlosnih točaka pri korištenju namjenske LED trake  
širine 5 mm

PA-GLAXMICNK-AL	2	Profilé, Perfil, Profile, Profil	Argent, plata, silberfarben, srebrni	aluminium, aluminio, Aluminium, aluminij	5902801281549
PA-GLAXMICNK3M-AL	3				5902801281495
PA-OSMLGLAXMIC-00N	2	protection micro, difusor micro, Abdeckung micro, mikro crijevo	blanc dépoli, blanco mate, milchig, mliječni	PC	5902801359910
PA-OSMLGLAXMIC3M-00N	3				5902801337239
PA-ZASGLAXMICNK-00	-	bouchon d'extrémité, tapa lateral, Endkappen, poklopac	gris, gris, grau, sivi	ABS	5902801200274
PA-SPRGLAXMIC-00	-	clip de fixation, soporte, Montageclip, ručka	Argent, plata, silberfarben, srebrni	Acier Inox, acero inoxidable, rostfreier Stahl, nehrđajući čelik	5902801244711

Protection / difusor / Abdeckungen / poklopac:

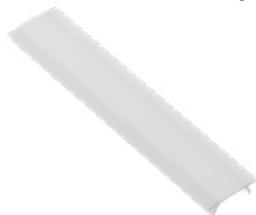

PA-OSMLGLAXMIC-00N  
PA-OSMLGLAXMIC3M-00N

Bouchon d'extrémité / tapa lateral / Endkappen /  
poklopac:



PA-ZASGLAXMICNK-00

Clip de fixation / soporte /  
Montageclip / ručka:



PA-SPRGLAXMIC-00



FR Profilé GLAX surface mini  
ES Perfil GLAX de superficie mini  
DE GLAX mini Aufsatzprofil  
HR Profil GLAX ugradni mini

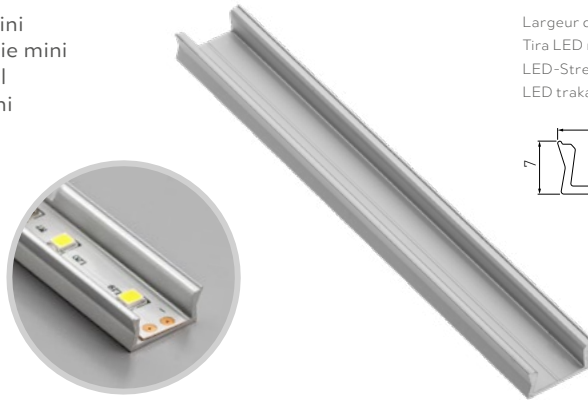

Largeur de bande LED max 10 mm  
Tira LED máx. 10 mm de anchura  
LED-Streifen max. 10 mm breit  
LED traka širine 10 mm

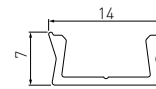

PA-GLAXMNK-AL	2	Profilé, Perfil, Profile, Profil	Argent, plata, silberfarben, srebrni	aluminium, aluminio, Aluminium, aluminij	5902801010316
PA-GLAXMNK-AL-20M			noir, negro, schwarz, crna		5902801256660
PA-GLAXMNK-AL-10			Blanc, blanco, weiß, bijeli		5902801256684
PA-GLAXMNK-AL-90			champagne, champán, Champagner, boja šampanjca		5902801256738
PA-GLAXMNK3M-AL	3		Argent, plata, silberfarben, srebrni		5902801010781
PA-GLAXMNK3M-AL-20M			noir, negro, schwarz, crna		5902801255854
PA-GLAXMNK3M-AL-10			Blanc, blanco, weiß, bijeli		5902801255779
PA-OSMLGLAXM-00	2	protection mini, difusor mini, Abdeckung mini, mini poklopac	blanc dépoli, blanco mate, milchig, mlječni	PC	5902801024023
PA-OSMLGLAXM3M-00	3		translucide, transparente, durchsichtig, transparentan		5902801024030
PA-OSTRGLAXM-00	2		noir, negro, schwarz, crna		5902801024054
PA-OSTRGLAXM3M-00	3				5902801395437
PA-OSCLGLAXM-00	2				5902801395581
PA-OSCLGLAXM3M-00	3				
PA-OSMLGLAXMK-00	2	protection carrée, difusor cuadrada, quadratische Abdeckung, četvrtasto crijevo	blanc dépoli, blanco mate, milchig, mlječni		5902801040511
PA-OSMLGLAXMO-00		protection ronde, difusor redonda, Abdeckung rund, okruglo crijevo			5902801222702
PA-ZASGLAXMNK-00	-	Cache standard, Tapa standard, Standard-Endkappen, standardni poklopac	gris, gris, grau, sivi	ABS	5902801024061
PA-ZASGLAXMNK-10			Blanc, blanco, weiß, bijeli		5902801241536
PA-ZASGLAXMNK-90			champagne, champán, Champagner, boja šampanjca		5902801245084
PA-ZASGLAXMNK-20M			noir mat, negro mate, schwarz matt, crni mat		5902801245268
PA-ZASGLAXMKNK-00	-	bouchon d'extrémité carré, tapa lateral cuadrado, quadratische Endkappe, kvadratni poklopac	gris, gris, grau, sivi		5902801222962
PA-ZASGLAXMNKO-00	-	bouchon d'extrémité rond, tapa lateral redondo, runde Endkappe, okrugli poklopac	gris, gris, grau, sivi		5902801222986
PA-SPRGLAXM-00	-	clip de fixation, soporte, Montageclip, ručka	Argent, plata, silberfarben, srebrni	Acier Inox, acero inoxidable, rostfreier Stahl, nehrđajući čelik	5902801244711

Protection / difusor / Abdeckungen / poklopac:



PA-OSMLGLAXM-00  
PA-OSMLGLAXM3M-00

PA-OSTRGLAXM-00  
PA-OSTRGLAXM3M-00

PA-OSCLGLAXM-00  
PA-OSCLGLAXM3M-00

PA-OSMLGLAXMO-00

PA-OSMLGLAXMK-00

Bouchon d'extrémité / tapa lateral / Endkappen / poklopac:



PA-ZASGLAXMNK-00

PA-ZASGLAXMKNK-00

PA-ZASGLAXMNKO-00

Clip de fixation / soporte / Montageclip / ručka:



PA-SPRGLAXM-00



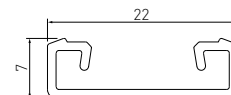

PA-GLAXNK-AL	2	Profilé, Perfil, Profile, Profil	Argent, plata, silberfarben, srebrni	aluminium, aluminio, Aluminium, aluminij	5901867127037
PA-GLAXNK3M-AL	3				5901867196606
PA-OSMLGLAX-00	2	protection mini, difusor mini, Abdeckung mini, mini poklopac	blanc dépoli, blanco mate, milchig, mliječni	PC	5901867111999
PA-OSMLGLAX3M-00	3				5901867197610
PA-OSTRGLAX-00	2				5901867112002
PA-OSTRGLAX3M-00	3		translucide, transparente, durchsichtig, transparentan		5901867197627
PA-ZASGLAXNK-00	-	bouchon d'extrémité, tapa lateral, Endkappen, poklopac	gris, gris, grau, sivi	ABS	5901867136411

Protection / difusor / Abdeckungen / poklopac:

Bouchon d'extrémité / tapa lateral / Endkappen / poklopac:

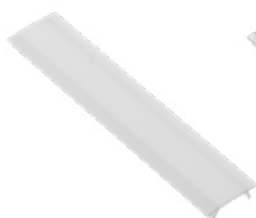

PA-OSMLGLAX-00  
PA-OSMLGLAX3M-00



PA-OSTRGLAX-00  
PA-OSTRGLAX3M-00



PA-ZASGLAXNK-00



FR Profilé GLAX surface mini, haut  
ES Perfil GLAX de superficie mini. alto  
DE Aufbauprofil GLAX mini, hoch  
HR Profil GLAX ugradni mini, visoki

Aucun point de lumière visible  
Largeur de bande LED max 10 mm  
Sin puntos de luz visibles  
Tira LED máx. 10 mm de anchura  
Keine sichtbaren Lichtpunkte  
LED-Streifen max. 10 mm breit  
Nema vidljivih svjetlosnih točaka  
LED traka širine 10 mm



White

Black

Silver

Champagne

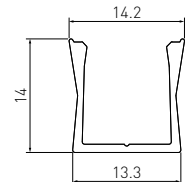

PA-GLAXMNKW-AL	2	Profilé, Perfil, Profile, Profil	Argent, plata, silberfarben, srebrni	aluminium, aluminio, Aluminium, aluminij	5902801027468	
PA-GLAXMNKW-AL-20M			noir, negro, schwarz, crna		5902801256929	
PA-GLAXMNKW-AL-10			Blanc, blanco, weiß, bijeli		5902801256851	
PA-GLAXMNKW-AL-90			champagne, champán, Champagner, boja šampanjca		5902801256813	
PA-OSMLGLAXM-00	2	protection mini, difusor mini, Abdeckung mini, mini poklopac	blanc dépoli, blanco mate, milchig, mlječni	PC	5902801024023	
PA-OSTRGLAXM-00			translucide, transparente, durchsichtig, transparentan		5902801024030	
PA-OSCLGLAXM-00			noir, negro, schwarz, crna		5902801395437	
PA-ZASGLAXMNKW-00	-	bouchon d'extrémité, tapa lateral, Endkappen, poklopac	gris, gris, grau, sivi	ABS	5902801223181	
PA-ZASGLAXMNKW-10			Blanc, blanco, weiß, bijeli		5902801241857	
PA-ZASGLAXMNKW-90			champagne, champán, Champagner, boja šampanjca		5902801241543	
PA-ZASGLAXMNKW-20M			noir mat, negro mate, schwarz matt, crni mat		5902801241802	
PA-SPRGLAXM-00	-	clip de fixation, soporte, Montageclip, ručka	Argent, plata, silberfarben, srebrni	Acier Inox, acero inoxidable, rostfreier Stahl, nehrđajući čelik	5902801244711	

Protection / difusor / Abdeckungen / poklopac:

Bouchon d'extrémité / tapa lateral / Endkappen / poklopac:

Clip de fixation / soporte / Montageclip / ručka:

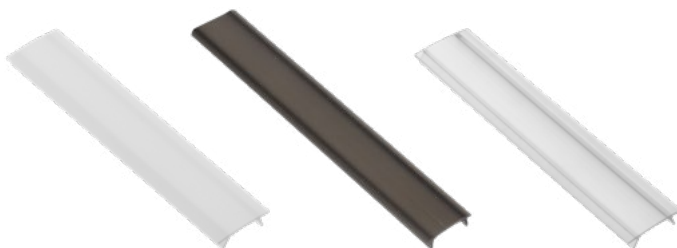

PA-OSMLGLAXM-00

PA-OSCLGLAXM-00

PA-OSTRGLAXM-00



PA-ZASGLAXMNKW-00



PA-SPRGLAXM-00

FR Profilé GLAX encastré micro  
ES Perfil GLAX empotrable micro  
DE Einlassprofil GLAX, hoch, micro  
HR Profil GLAX ugradbeni mikro

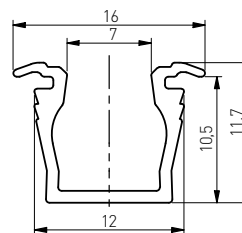
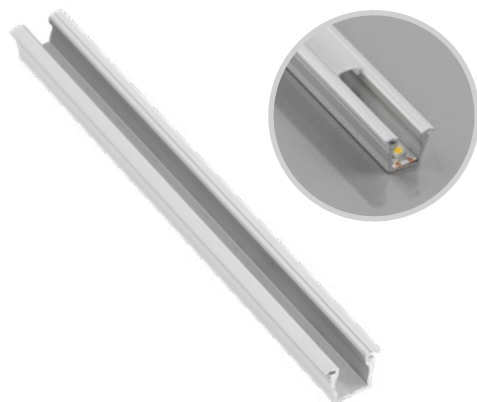

Ligne de lumière étroite,  
Aucun point d'éclairage lors de l'utilisation  
de la  
bande LED dédiée d'une largeur 5 mm  
Línea de luz delgada,  
Sin puntos de luz al utilizar  
una tira LED dedicada de anchura 5 mm  
Schmale Lichtlinie. Keine Lichtpunkte bei  
Verwendung eines speziellen LED-Streifens  
mit  
einer Breite von 5 mm.  
Uska linija svjetla,  
nema svjetlosnih točaka pri korištenju  
namjenske LED trake širine 5 mm

PA-GLAXMIC-AL	2	Profilé, Perfil, Profile, Profil	Argent, plata, silberfarben, srebrni	aluminium, aluminio, Aluminium, aluminij	5902801281600
PA-GLAXMIC3M-AL	3				5902801281839
PA-OSMLGLAXMIC-00N	2	protection micro, difusor micro, Abdeckung micro, mikro crijevo	blanc dépoli, blanco mate, milchig, mliječni	PC	5902801359910
PA-OSMLGLAXMIC3M-00N	3				5902801337239
PA-ZASGLAXMIC-00	-	bouchon d'extrémité, tapa lateral, Endkappen, poklopac	gris, gris, grau, sivi	ABS	5902801200205

Protection / difusor / Abdeckungen / poklopac:



PA-OSMLGLAXMIC-00N  
PA-OSMLGLAXMIC3M-00N

Bouchon d'extrémité / tapa lateral / Endkappen / poklopac:



PA-ZASGLAXMIC-00

FR Profilé GLAX encastré  
ES Perfil GLAX empotrable  
DE GLAX Einlassprofil  
HR Profil GLAX ugradbeni

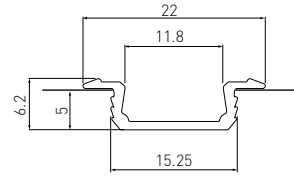

PA-GLAX-AL	2	Profilé, Perfil, Profile, Profil	Argent, plata, silberfarben, srebrni	aluminium, aluminio, Aluminium, aluminij	5901867111975
PA-GLAX-AL-20M			noir, negro, schwarz, crna		5902801256431
PA-GLAX-AL-10			Blanc, blanco, weiß, bijeli		5902801256691
PA-GLAX-AL-90			champagne, champán, Champagner, boja šampanjca		5902801256639
PA-GLAX3M-AL	3	Profilé, Perfil, Profile, Profil	Argent, plata, silberfarben, srebrni	aluminium, aluminio, Aluminium, aluminij	5901867196583
PA-GLAX3M-AL-20M			noir, negro, schwarz, crna		5902801308789
PA-GLAX3M-AL-10			Blanc, blanco, weiß, bijeli		5902801308932
PA-OSMLGLAX-00	2	protection, difusor, Abdeckungen, poklopac	blanc dépoli, blanco mate, milchig, mliječni	PC	5901867111999
PA-OSMLGLAX3M-00	3				5901867197610
PA-OSTRGLAX-00	2		translucide, transparente, durchsichtig, transparentan		5901867112002
PA-OSTRGLAX3M-00	3		5901867197627		
PA-OSCLGLAX-00	2		noir, negro, schwarz, crna		5902801395161
PA-OSCLGLAX3M-00	3				5902801395314
PA-ZASGLAX-00	-	bouchon d'extrémité, tapa lateral, Endkappen, poklopac	gris, gris, grau, sivi	ABS	5901867111982
PA-ZASGLAX-10			Blanc, blanco, weiß, bijeli		5902801245145
PA-ZASGLAX-90			champagne, champán, Champagner, boja šampanjca		5902801245169
PA-ZASGLAX-20M			noir mat, negro mate, schwarz matt, crni mat		5902801244674

Protection / difusor / Abdeckungen / poklopac:

Bouchon d'extrémité / tapa lateral / Endkappen / poklopac:

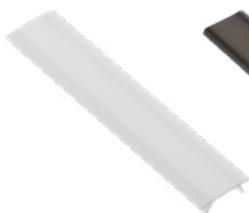

PA-OSMLGLAX-00  
PA-OSMLGLAX3M-00

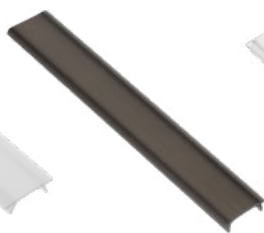

PA-OSCLGLAX-00



PA-OSTRGLAX-00  
PA-OSTRGLAX3M-00



PA-ZASGLAX-00

FR Profilé GLAX encastré, haut  
ES Perfil GLAX empotrable, alto  
DE Einlassprofil GLAX, hoch  
HR Profil GLAX ugradbeni, visoki



Aucun point de lumière visible  
Largeur de bande LED max 10 mm  
Sin puntos de luz visibles  
Tira LED máx. 10 mm de anchura  
Keine sichtbaren Lichtpunkte  
LED-Streifen max. 10 mm breit  
Nema vidljivih svjetlosnih točaka  
LED traka širine 10 mm

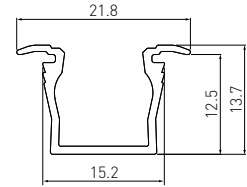

PA-GLAXMW-AL	2	Profilé, Perfil, Profile, Profil	Argent, plata, silberfarben, srebrni	aluminium, aluminio, Aluminium, aluminij	5902801027475
PA-GLAXMW-AL-20M			noir, negro, schwarz, crna		5902801256967
PA-GLAXMW-AL-10			Blanc, blanco, weiß, bijeli		5902801256622
PA-GLAXMW-AL-90			champagne, champán, Champagner, boja šampanjca		5902801257049
PA-OSCLGLAXM-00	2	protection mini, difusor mini, Abdeckung mini, mini poklopac	noir, negro, schwarz, crna	PC	5902801395437
PA-OSMLGLAXM-00		protection carrée, difusor cuadrada, quadratische Abdeckung, četvrtasto crijevo	blanc dépoli, blanco mate, milchig, mlječni		5902801024023
PA-OSMLGLAXMK-00			translucide, transparente, durchsichtig, transparentan		5902801024030
PA-OSTRGLAXM-00	-	Cache standard, Tapa standard, Standard-Endkappen, standardni poklopac	gris, gris, grau, sivi	ABS	5902801040481
PA-ZASGLAXMW-10			Blanc, blanco, weiß, bijeli		5902801241635
PA-ZASGLAXMW-90			champagne, champán, Champagner, boja šampanjca		5902801242090
PA-ZASGLAXMW-20M			noir mat, negro mate, schwarz matt, crni mat		5902801241628
PA-ZASGLAXMWK-00	-	bouchon d'extrémité carré, tapa lateral cuadrado, quadratische Endkappe, kvadratni poklopac	gris, gris, grau, sivi		5902801040559

Protection / difusor / Abdeckungen / poklopac:

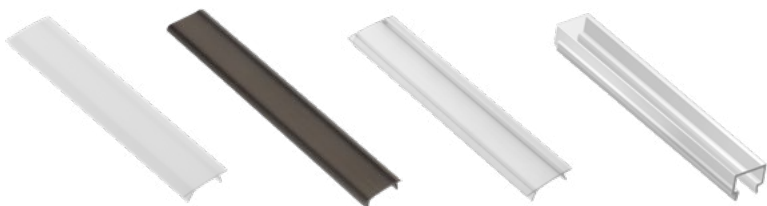

PA-OSMLGLAXM-00

PA-OSCLGLAXM-00

PA-OSTRGLAXM-00

PA-OSMLGLAXMK-00

Bouchon d'extrémité / tapa lateral / Endkappen / poklopac:



PA-ZASGLAXMW-00

PA-ZASGLAXMWK-00



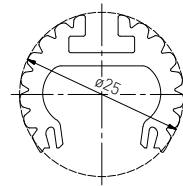

Options d'assemblage comme  
Posibilidad de montaje como  
Befestigungsmöglichkeiten als  
Opcije montaže kao

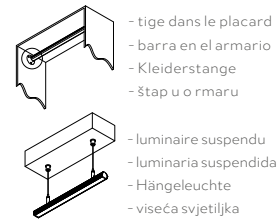

Icon: Folder	Icon: Length (m)	Icon: Information (i)	Icon: Material	Icon: Color	Icon: Barcode
PA-GLAXDR-AL		Profilé, Perfil, Profile, Profil	Argent, plata, silberfarben, srebrni	aluminium, aluminio, Aluminium, aluminij	5902801258954
PA-OSMLGLAX-00	2	protection, difusor, Abdeckungen, poklopac	blanc dépoli, blanco mate, milchig, mliječni	PC	5901867111999
PA-OSTRGLAX-00			translucide, transparente, durchsichtig, transparentan		5901867112002
PA-ZASGLAXDR-00	-	bouchon d'extrémité, tapa lateral, Endkappen, poklopac	gris, gris, grau, sivi		ZnAl
PA-ROZGLAX-53	-	support rail, Roseta, Rosette, rozeta		5902801018046	
PA-ROZGLAXP-53	-	support rail PREMIUM, RosetA PREMIUM, RoseTTE PREMIUM, rOZETA PREMIUM			5902801226359
PA-ZAWGLAXDR-00	1,5	pendentif, colgador, Aufhängung, vješalica	chrome, cromado, Chrom, krom	stal, steel, сталь, сталь	5902801046506

Protection / difusor / Abdeckungen / poklopac:



PA-OSMLGLAX-00

PA-OSTRGLAX-00

Bouchon d'extrémité / tapa lateral / Endkappen / poklopac:



PA-ZASGLAXDR-00

Support rail / Roseta / Rosette / rozeta



PA-ROZGLAX-53

PA-ROZGLAXP-53

Pendentif / colgador / Aufhänger / vješalica:



PA-ZAWGLAXDR-00

FR Profilé GLAX avec radiateur  
 ES Perfil GLAX con radiador  
 DE Profil GLAX mit Kühler  
 HR Profil GLAX s rebrima za hlađenje

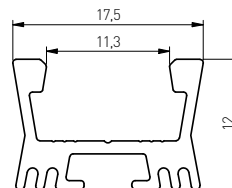

Lentille dédiée qui réduit l'angle de faisceau à 60 degrés  
 Possibilité de suspendre le montage à l'aide de lignes  
 Lente dedicada que aumenta el ángulo de apertura hasta los 60°  
 Posibilidad de suspender la luminaria mediante cables  
 Spezielle Linse, die den Abstrahlwinkel auf 60° verengt. Möglichkeit zum Aufhängen der Leuchte mit Seilen.  
 Namjenski objektivi koji sužava kut osvijetljenja do 60°  
 Kućište se može objesiti pomoću užadi

PA-GLAXRAD-AL	2	Profilé, Perfil, Profile, Profil	Argent, plata, silberfarben, srebrni	aluminium, aluminio, Aluminium, aluminij	5902801281877
PA-OSMLGLAXSO-00	2	protection lentille, protector de la lente, Linsenabdeckung, poklopac objektiva	translucide, transparente, durchsichtig, transparentan	PMMA	5902801293153
PA-OSMLGLAX-00	2	protection, difusor, Abdeckungen, poklopac	blanc dépoli, blanco mate, milchig, mliječni	PC	5901867111999
PA-OSTRGLAX-00			translucide, transparente, durchsichtig, transparentan		5901867112002
PA-ZASGLAXRAD-00	-	bouchon d'extrémité, tapa lateral, Endkappen, poklopac	gris, gris, grau, sivi	ABS	5902801200373
PA-ZAWGLAXDR-00	1,5	pendentif, colgador, Aufhängung, vješalica	chrome, cromado, Chrom, krom	stal, steel, сталь, сталь	5902801046506
PA-SPRGLAXM-00	-	clip de fixation, soporte, Montageclip, ručka	Argent, plata, silberfarben, srebrni	Acier Inox, acero inoxidable, rostfreier Stahl, nehrđajući čelik	5902801244711

Protection / difusor / Abdeckungen / poklopac:

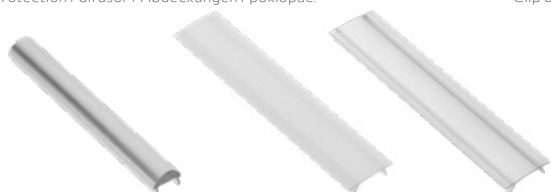

PA-OSMLGLAXSO-00

PA-OSMLGLAX-00

PA-OSTRGLAX-00

Clip de fixation / soporte / Montageclip / ručka:



PA-SPRGLAXM-00

Pendentif / colgador / Aufhänger / vješalica:



PA-ZAWGLAXDR-00



FR Profilé GLAX avec radiateur  
ES Perfil GLAX con radiador  
DE Schrankunterbodenprofil GLAX  
HR Rubni GLAX profil



White

Black

Silver

Champagne

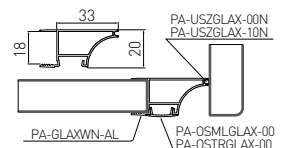

Folder	BOARD mm	L m	i	Material	Color	Barcode
PA-GLAXWN-AL	18	2	Profilé, Perfil, Profile, Profil	aluminium, aluminio, Aluminium, aluminij	Argent, plata, silberfarben, srebrni	5902801258619
PA-GLAXWN3M-AL					5902801363511	
PA-GLAXWN3M-AL-20M		3			noir, negro, schwarz, crna	5902801363535
PA-GLAXWN3M-AL-10					Blanc, blanco, weiß, bijeli	5902801363641
PA-GLAXWN3M-AL-06					inox, inox, inox, inox, inox	5902801363665
PA-GLAXWN16-AL	16	2	protection, difusor, Abdeckungen, poklopac	PC	Argent, plata, silberfarben, srebrni	5902801210969
PA-GLAXWN19-AL	19				5902801210723	
PA-OSMLGLAX-00	-	2			blanc dépoli, blanco mate, milchig, mlječni	5901867111999
PA-OSTRGLAX-00	-				translucide, transparente, durchsichtig, transparentan	5901867112002
PA-OSCLGLAX-00	-				noir, negro, schwarz, crna	5902801395161
PA-OSMLGLAX3M-00	-	3	blanc dépoli, blanco mate, milchig, mlječni	5901867197610		
PA-OSTRGLAX3M-00	-		translucide, transparente, durchsichtig, transparentan	5901867197627		
PA-OSCLGLAX3M-00	-		noir, negro, schwarz, crna	5902801395314		
PA-USZGLAX-00N	-	10	Joint d'étanchéité, junta, Dichtung, brtva	EPDM	noir, negro, schwarz, crna	5902801021039
PA-USZGLAX-10N	-				Blanc, blanco, weiß, bijeli	5902801297502

Protection / difusor / Abdeckungen / poklopac:

Joint d'étanchéité / junta / Dichtung / brtva:

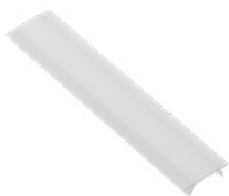

PA-OSMLGLAX-00  
PA-OSMLGLAX3M-00



PA-OSCLGLAX-00  
PA-OSCLGLAX3M-00



PA-OSTRGLAX-00



PA-USZGLAX-00N



PA-USZGLAX-10N

FR Profilé d'angle GLAX, surface  
ES Perfil GLAX angular, de superficie  
DE Aufbau-Winkelprofil | GLAX  
HR Profil GLAX kutni, nadgradni

**meble**  
2019 **plus**  
PRODUKT ROKU



White

Black

Silver

Champagne

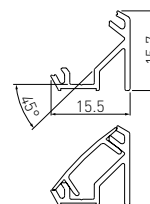

Icon: Folder	Icon: Length (L) in meters	Icon: Information (i)	Icon: Recycle	Icon: Recycle	Icon: Barcode
PA-GLAXNKKT-AL	2	Profilé, Perfil, Profile, Profil	Argent, plata, silberfarben, srebrni	aluminium, aluminio, Aluminium, aluminij	5901867199089
PA-GLAXNKKT-AL-20M			noir, negro, schwarz, crna		5902801256721
PA-GLAXNKKT-AL-10			Blanc, blanco, weiß, bijeli		5902801259647
PA-GLAXNKKT-AL-90			champagne, champán, Champagner, boja šampanjca		5902801256868
PA-GLAXNKKT3M-AL	3	Profilé, Perfil, Profile, Profil	Argent, plata, silberfarben, srebrni	aluminium, aluminio, Aluminium, aluminij	5901867199072
PA-GLAXNKKT3M-AL-20M			noir, negro, schwarz, crna		5902801308758
PA-GLAXNKKT3M-AL-10			Blanc, blanco, weiß, bijeli		5902801308956
PA-OSMLGLAX-00	2	protection, difusor, Abdeckungen, poklopac	blanc dépoli, blanco mate, milchig, mliječni	PC	5901867111999
PA-OSMLGLAX3M-00	3		translucide, transparente, durchsichtig, transparentan		5901867197610
PA-OSTRGLAX-00	2		noir, negro, schwarz, crna		5901867112002
PA-OSTRGLAX3M-00	3				5901867197627
PA-OSCLGLAX-00	2				5902801395437
PA-OSCLGLAX3M-00	3				5902801395314
PA-OSMLGLAXT-00	2	protection triangulaire, difusor triangular, dreieckige Abdeckung, trokutasto crijevo	blanc dépoli, blanco mate, milchig, mliječni	ABS	5902801040627
PA-ZASGLAXNKKT-00	-	Cache standard, Tapa standard, Standard-Endkappen standardni poklopac	gris, gris, grau, sivi		5902801222900
PA-ZASGLAXNKKT-10			Blanc, blanco, weiß, bijeli		5902801241734
PA-ZASGLAXNKKT-90			champagne, champán, Champagner, boja šampanjca		5902801245152
PA-ZASGLAXNKKT-20M			noir mat, negro mate, schwarz matt, crni mat		5902801244476
PA-ZASGLAXNKKT-00		bouchon d'extrémité triangulaire, tapa lateral triangular, dreieckige Endkappen, trokutni poklopac	gris, gris, grau, sivi		5902801223136
PA-SPRGLAXMIC-00	-	clip de fixation, soporte, Montageclip, ručka	Argent, plata, silberfarben, srebrni	Acier Inox, acero inoxidable, rostfreier Stahl, nehrđajući čelik	5902801244711

Protection / difusor / Abdeckungen / poklopac:

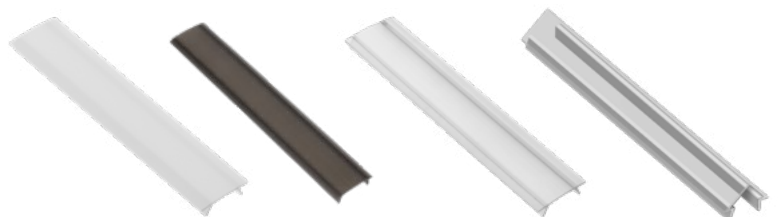

PA-OSMLGLAX-00  
PA-OSMLGLAX3M-00

PA-OSCLGLAX-00  
PA-OSCLGLAX3M-00

PA-OSTRGLAX-00  
PA-OSTRGLAX3M-00

PA-OSMLGLAXT-00

Bouchon d'extrémité / tapa lateral / Endkappen / poklopac:



PA-ZASGLAXNKKT-00

PA-ZASGLAXNKKT-00

Clip de fixation / soporte / Montageclip / ručka:



PA-SPRGLAXMIC-00



FR Profilé GLAX pour base étroit, 2 face  
 ES Perfil GLAX de corona, estrecho doble sola cara  
 DE Sockelprofil GLAX, doppelseitig, schmal  
 HR Rubni profil GLAX uski dvostrani

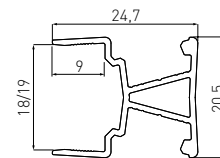

PA-GLAXMNBW3M-AL	18	3	Profilé, Perfil, Profile, Profil	Argent, plata, silberfarben, srebrni	aluminium, aluminio, Aluminium, aluminij	5902801259142
PA-GLAXMNBW3M19-AL	19					5902801281594
PA-OSMLGLAXM3M-00	-		protection mini, difusor mini, Abdeckung mini, mini poklopac	blanc dépoli, blanco mate, milchig, mliježni	PC	5902801024054
PA-OSTRGLAXM3M-00	-		translucide, transparente, durchsichtig, transparentan	5902801024047		

Protection / difusor / Abdeckungen / poklopac:



PA-OSMLGLAXM3M-00



PA-OSTRGLAXM3M-00

FR Profilé GLAX pour base étroit, 1 face  
 ES Perfil GLAX de corona, estrecho una sola cara  
 DE Sockelprofil GLAX, einseitig, schmal  
 HR Rubni profil GLAX uski jednostrani

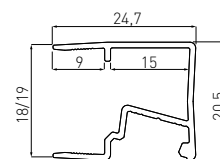

PA-GLAXMNBW3M-AL	18	3	Profilé, Perfil, Profile, Profil	Argent, plata, silberfarben, srebrni	aluminium, aluminio, Aluminium, aluminij	5902801259128
PA-GLAXMNBW3M19-AL	19					5902801281563
PA-OSMLGLAXM3M-00	-		protection, difusor, Abdeckungen, poklopac	blanc dépoli, blanco mate, milchig, mliježni	PC	5902801024054
PA-OSTRGLAXM3M-00	-			translucide, transparente, durchsichtig, transparentan		5902801024047

Protection / difusor / Abdeckungen / poklopac:



PA-OSMLGLAXM3M-00



PA-OSTRGLAXM3M-00

FR Profilé GLAX mini  
ES Perfil GLAX para mini anaquel  
DE Profi GLAX mini für Glaskantenbeleuchtung  
HR Profil GLAX za police, mini

Possibilité d'utiliser 3 bandes LED  
Posibilidad de emplear 3 tiras LED  
Einsatzmöglichkeit von 3 LED-Streifen  
Mogućnost korištenja tri LED trake

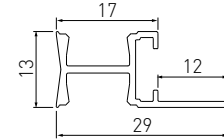
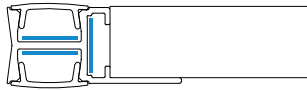

PA-GLAXMPK-AL	2	Profilé, Perfil, Profile, Profil	Argent, plata, silberfarben, srebrni	aluminium, aluminio, Aluminium, aluminij	5902801258633
PA-OSMLGLAXM-00	2	protection mini, difusor mini, Abdeckung mini, mini poklopac	blanc dépoli, blanco mate, milchig, mliječni	PC	5902801024030
PA-OSTRGLAXM-00			translucide, transparente, durchsichtig, transparentan		5902801024023

Protection / difusor / Abdeckungen / poklopac:



PA-OSMLGLAXM-00



PA-OSTRGLAXM-00

FR Profilé GLAX avec angle réglable de lumière  
ES Perfil GLAX con regulación de ángulo de iluminación  
DE GLAX Profil, Leuchtwinkel einstellbar  
HR Profil GLAX s regulacijom kuta svjetlosti

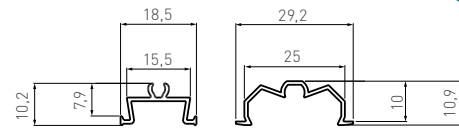

PA-GLAXREG1-AL	2	Profilé, Perfil, Profile, Profil	Argent, plata, silberfarben, srebrni	aluminium, aluminio, Aluminium, aluminij	5902801257773
PA-GLAXREG2-AL	2	protection mini, difusor mini, Abdeckung mini, mini poklopac	blanc dépoli, blanco mate, milchig, mliječni	PC	5902801257797
PA-OSTRGLAX-00			translucide, transparente, durchsichtig, transparentan		5901867111999
PA-OSTRGLAX-00					5901867112002

Protection / difusor / Abdeckungen / poklopac:



PA-OSMLGLAX-00



PA-OSTRGLAX-00

FR Profilé GLAX pour base 1 face  
 ES Perfil GLAX de zócalo, unilateral  
 DE Sockelprofil GLAX, einseitig  
 HR Rubni profil GLAX jednostrani

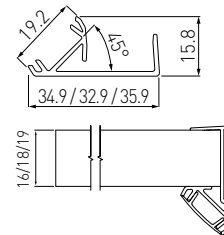

PA-GLAXNB3M16-AL	16	3	Profilé, Perfil, Profile, Profil	Argent, plata, silberfarben, srebrni	aluminium, aluminio, Aluminium, aluminij	5902801257834
PA-GLAXNB3M-AL	18	3				5902801258626
PA-GLAXNB3M19-AL	19	3				5902801257605
PA-OSMLGLAX3M-00	-	3	protection, difusor, Abdeckungen, poklopac	blanc dépoli, blanco mate, milchig, mliječni	PC	5901867197610
PA-OSTRGLAX3M-00	-	3		translucide, transparente, durchsichtig, transparentan		5901867197627

Protection / difusor / Abdeckungen / poklopac:



PA-OSMLGLAX3M-00



PA-OSTRGLAX3M-00

FR Profilé GLAX base 1 face, à remplir avec une bordure  
 ES Perfil GLAX de zócalo, unilateral, cubre cantos  
 DE Sockelprofil GLAX, einseitig, mit Platz für Randstreifen  
 HR Rubni profil GLAX jednostrani za ispunu s ABS rubnom trakom

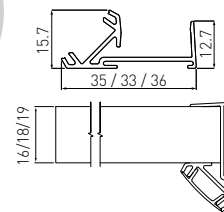

PA-GLAXNB3M16-AL	16	3	Profilé, Perfil, Profile, Profil	Argent, plata, silberfarben, srebrni	aluminium, aluminio, Aluminium, aluminij	5902801259036
PA-GLAXNB3M-AL	18	3				5902801258657
PA-GLAXNB3M19-AL	19	3				5902801258978
PA-OSMLGLAX3M-00	-	3	protection, difusor, Abdeckungen, poklopac	blanc dépoli, blanco mate, milchig, mliječni	PC	5901867197610
PA-OSTRGLAX3M-00	-	3		translucide, transparente, durchsichtig, transparentan		5901867197627

Protection / difusor / Abdeckungen / poklopac:



PA-OSMLGLAX3M-00



PA-OSTRGLAX3M-00

FR Profilé GLAX cloison, 2 faces  
 ES Perfil GLAX para separaciones, doble  
 DE Sockelprofil GLAX, einseitig, mit Platz für Randstreifen  
 HR Rubni profil GLAX dvostrani

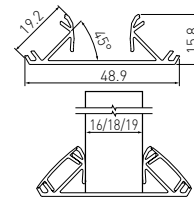

PA-GLAXNBD3M16-AL	16	3	Profilé, Perfil, Profile, Profil	Argent, plata, silberfarben, srebrni	aluminium, aluminio, Aluminium, aluminij	5902801259012
PA-GLAXNBD3M-AL	18	3				5902801258640
PA-GLAXNBD3M19-AL	19	3				5902801257650
PA-OSMLGLAX3M-00	-	3	protection, difusor, Abdeckungen, poklopac	blanc dépoli, blanco mate, milchig, mliječni	PC	5901867197610
PA-OSTRGLAX3M-00	-	3				translucide, transparente, durchsichtig, transparentan

Protection / difusor / Abdeckungen / poklopac:



PA-OSMLGLAX3M-00



PA-OSTRGLAX3M-00

FR Profilé GLAX cloison, 2 faces, à remplir avec une bordure  
 ES Perfil GLAX para separaciones, doble, cubre cantos  
 DE Trennprofil GLAX, doppelseitig, mit Platz für Randstreifen  
 HR Rubni profil GLAX dvostrani za ispunu s ABS rubnom trakom

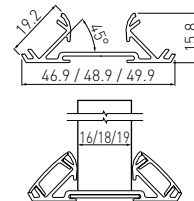

PA-GLAXNBDW3M16-AL	16	3	Profilé, Perfil, Profile, Profil	Argent, plata, silberfarben, srebrni	aluminium, aluminio, Aluminium, aluminij	5902801259050
PA-GLAXNBDW3M-AL	18	3				5902801258664
PA-GLAXNBDW3M19-AL	19	3				5902801257803
PA-OSMLGLAX3M-00	-	3	protection, difusor, Abdeckungen, poklopac	blanc dépoli, blanco mate, milchig, mliječni	PC	5901867197610
PA-OSTRGLAX3M-00	-					translucide, transparente, durchsichtig, transparentan

Protection / difusor / Abdeckungen / poklopac:



PA-OSMLGLAX3M-00



PA-OSTRGLAX3M-00



FR Profilé GLAX d'angle pour ruban LED  
 ES Perfil GLAX angular  
 DE Winkelprofil GLAX  
 HR Profil GLAX kutni



PA-GLAXKT-AL	2	Profilé, Perfil, Profile, Profil	Argent, plata, silberfarben, srebrni	aluminium, aluminio, Aluminium, aluminij	5901867127020
PA-GLAXKT3M-AL	3				5901867196590
PA-OSMLGLAX-00	2	protection, difusor, Abdeckungen, poklopac	blanc dépoli, blanco mate, milchig, mliječni	PC	5901867111999
PA-OSMLGLAX3M-00	3				5901867197610
PA-OSTRGLAX-00	3				5901867112002
PA-OSTRGLAX3M-00	2				5901867197627
PA-ZASGLAXKT-00	-	bouchon d'extrémité, tapa lateral, Endkappen, poklopac	gris, gris, grau, sivi	ABS	5901867136428

Protection / difusor / Abdeckungen / poklopac:

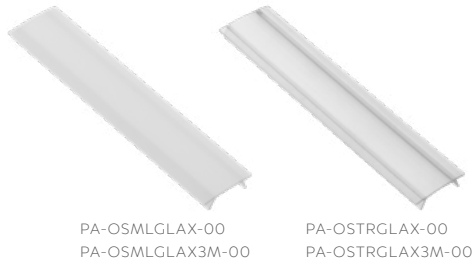

Bouchon d'extrémité / tapa lateral / Endkappen / poklopac:



FR Profilé GLAX coudé, encastré  
 ES Perfil GLAX angular, empotrable  
 DE Einlass-Winkelprofil GLAX  
 HR Profil GLAX kutni, ugradni

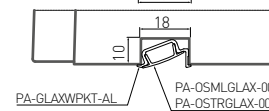

Angle de faisceau 22°  
 Ángulo de iluminación 22°  
 Strahlungswinkel 22°  
 Kut svjetlosti 22°



PA-GLAXWPKT-AL	2	Profilé, Perfil, Profile, Profil	Argent, plata, silberfarben, srebrni	aluminium, aluminio, Aluminium, aluminij	5902801257742
PA-OSMLGLAX-00					5901867111999
PA-OSTRGLAX-00		protection, difusor, Abdeckungen, poklopac	blanc dépoli, blanco mate, milchig, mliječni	translucide, transparente, durchsichtig, transparentan	PC

Protection / difusor / Abdeckungen / poklopac:



FR Ensemble de profilé GLAX encastré  
ES Conjunto de perfil GLAX empotrable  
DE Einlassprofilset GLAX  
HR GLAX set ugradni

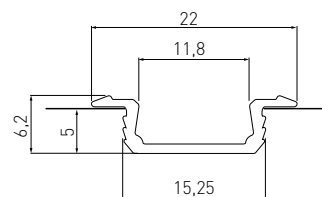

Folder	Length (m)	Material	Material	Barcode
PA-ZGLAXOMZ-00	2	Argent, plata, silberfarben, srebrni	aluminium, PC blanc dépoli, ABS; aluminio, PC blanco mate, ABS; Aluminium, PC milchig, ABS; aluminij, PC mlječni, ABS	5902801255748
PA-ZGLAXOMZ-20M		noir, negro, schwarz, crna		5902801386640
PA-ZGLAXOMZ-10		Blanc, blanco, weiß, bijeli		5902801387128

FR Ensemble de profilé GLAX surface mini  
ES Conjunto de perfil GLAX de superficie mini  
DE Aufbauprofilset GLAX mini  
HR GLAX set ugradni mini

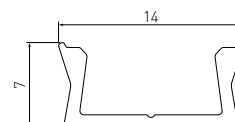

Folder	Length (m)	Material	Material	Barcode
PA-ZGLAXMNKOMZ-00	2	Argent, plata, silberfarben, srebrni	aluminium, PC blanc dépoli, ABS; aluminio, PC blanco mate, ABS; Aluminium, PC milchig, ABS; aluminij, PC mlječni, ABS	5902801255885
PA-ZGLAXMNKOMZ-20M		noir, negro, schwarz, crna		5902801386176
PA-ZGLAXMNKOMZ-10		Blanc, blanco, weiß, bijeli		5902801386503

FR Ensemble de profilé GLAX surface mini  
 ES Conjunto de perfil GLAX de superficie mini  
 DE Winkelprofilset GLAX  
 HR GLAX set kutni

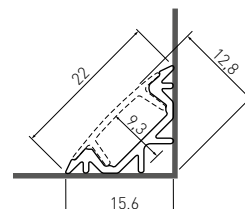

PA-ZGLAXKTOMZ-00	2	Argent, plata, silberfarben, srebrni	aluminium, PC blanc dépoli, ABS; aluminio, PC blanco mate, ABS; Aluminium, PC milchig, ABS; aluminij, PC mliječni, ABS	5902801255892

FR Profilé d'angle GLAX, surface  
 ES Perfil GLAX angular, de superficie  
 DE Aufbau-Winkelprofil GLAX  
 HR Profil GLAX kutni, nadgradni



White

Black

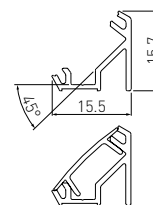

PA-ZGLAXNKKTOMZ-20M	2	noir, negro, schwarz, crna	aluminium, PC blanc dépoli, ABS; aluminio, PC blanco mate, ABS; Aluminium, PC milchig, ABS; aluminij, PC mliječni, ABS	5902801386343
PA-ZGLAXNKKTOMZ-10		Blanc, blanco, weiß, bijeli		5902801386572



BODY LOTION  
SOUL, CREATIVITY & LOVE  
ABSORBS QUICKLY

[ Linen dew ]  
HAND CREAM

[ orange and geranium ]  
100% organic oil  
for the whole family  
www.meraki-shop.dk  
PURE OIL

[ the earth ]  
Contains organic rosemary with a  
cleansing and moisturizing effect  
www.meraki-shop.dk  
BODY LOTION

[ the earth ]  
BODY LOTION

SHAVE CREAM

SHAVE CREAM







LUMINAIRE LED  
LUMINARIA LED  
LED-LEUCHTE  
LED SVJETILJKE

FR Luminaire appliqué / encastré  
ES Foco de superficie / empotrable  
DE Auf- bzw. Einbauleuchte  
HR LED svjetiljka ugradna/nadgradna

## VASCO

360°

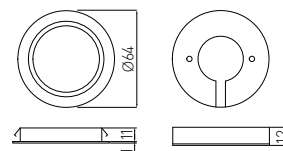

LD-VA24CB-53	130 lm	● 3000 K	aluminium, aluminio, Aluminium, aluminij	Plastique, plastico, Kunststoff, plastika	5908231382627
LD-VA24NE-53		● 4000 K			5908231382641



FR Luminaire LED  
ES Luminaria LED  
DE LED-Leuchte  
HR LED svjetiljka

## LUMINO

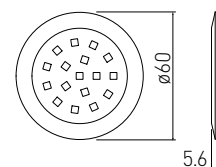

LD-LU16CB-53	85 lm	● 2700 K	aluminium, aluminio, Aluminium, aluminij	Plastique, plastico, Kunststoff, plastika	5901867164742
LD-LU16NE-53		● 4000 K			5901867160874
LD-LU16ZB-53		● 6500 K			5901867160850



FR Luminaire avec interrupteur LED  
ES Foco con interruptor LED  
DE LED Aufbauleuchte mit Schalter  
HR LED svjetiljka s prekidačem

## CASTELLO

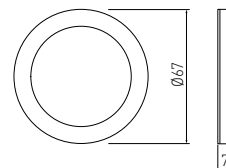

Folder	Light	Color	Material	Barcode	
LD-CS36CB-53	180 lm	● 3000 K	aluminium, aluminio, Aluminium, aluminij	Plastique, plastico, Kunststoff, plastika	
LD-CS36NE-53		● 4000 K			5908231382597
LD-CS36ZB-53		● 6200 K			5908231382603
				5908231382610	



FR Luminaire encastré LED  
ES Foco empotrable LED  
DE LED-Einbauleuchte  
HR LED svjetiljka ugradna

## ALVARO

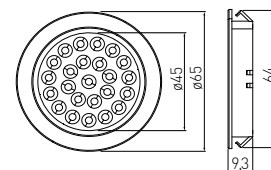

Folder	Light	Color	Material	Barcode	
LD-AL24CB-53	130 lm	● 3000 K	aluminium, aluminio, Aluminium, aluminij	Plastique, plastico, Kunststoff, plastika	
LD-AL24NE-53		● 4000 K			5901867156976
LD-AL24ZB-53		● 6400 K			5901867156969
				5901867156952	



FR Luminaire LED  
ES Luminaria LED  
DE LED-Leuchte  
HR LED svjetiljka

## VEGAS

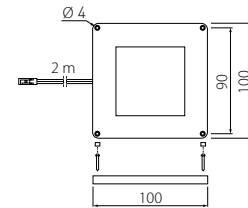

LD-VE15CB-53N	140 lm	● 3000 K	aluminium, aluminio, Aluminium, aluminij	aluminium + Plastique, aluminio + plastico, Aluminium + Kunststoff, aluminij + plastika	5902801236655
LD-VE15NE-53N	145 lm	● 4000 K			5902801236730
LD-VE15ZB-53N	150 lm	● 6400 K			5902801235610



FR Luminaire 2 en 1  
ES Foco 2 en 1  
DE Aufbauleuchte 2-in-1  
HR LED svjetiljka 2 u 1

## VEGAS

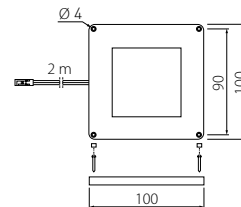

Produits connexes:  
Interrupteur sans contact sans fil CCT  
AE-WDBP2CCT-10N, AE-WDBP2CCT-20N

Productos relacionados:  
Interruptor táctil inalámbrico CCT  
AE-WDBP2CCT-10N, AE-WDBP2CCT-20N

Verwandte Produkte:  
Kabelloser Berührungsschalter CCT  
AE-WDBP2CCT-10N, AE-WDBP2CCT-20N

Povezani proizvodi  
Bežični dodirni prekidač CCT  
AE-WDBP2CCT-10N, AE-WDBP2CCT-20N



DUO-COLOR



LD-VE15CBZB-53N	140 lm	● 3000 K - ● 6400 K	aluminium, aluminio, Aluminium, aluminij	aluminium + Plastique, aluminio + plastico, Aluminium + Kunststoff, aluminij + plastika	5902801235627





## TREVI

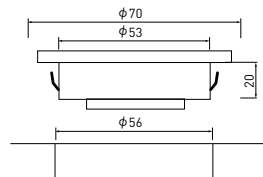

Folder	Light	Color	Material	Material	Barcode
LD-TR24CB-53	300 lm	3000 K	aluminium, aluminio, Aluminium, aluminij	Plastique, plastico, Kunststoff, plastika	5902801032905
LD-TR24NE-53	220 lm	4000 K			5902801298950
LD-TR24ZB-53	300 lm	6400 K			5902801032998



FR Kit de luminaires avec interrupteur  
ES Conjunto de luminarias con interruptor  
DE Leuchtensatz mit Schalter  
HR Set LED svjetiljki s prekidačem

## CASTELLO

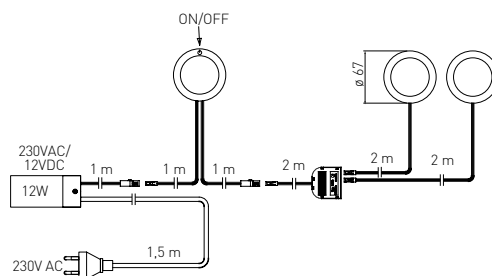
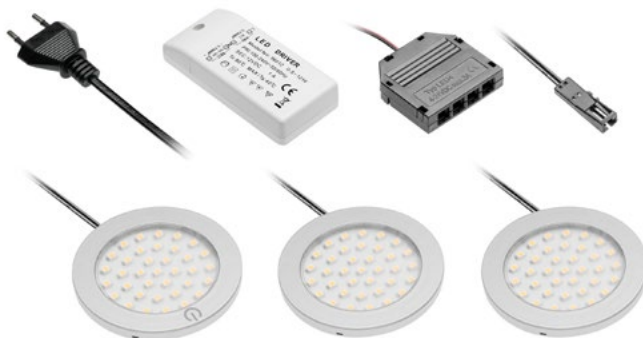

Folder	Light	Color	Material	Material	Barcode
LD-Z3CSCB-53	3 x 180 lm	3000 K	aluminium, aluminio, Aluminium, aluminij	Plastique, plastico, Kunststoff, plastika	5908231389251



FR Ensemble de luminaires  
ES Conjunto de focos  
DE Leuchtenset  
HR Set LED svjetiljki

## BARRI

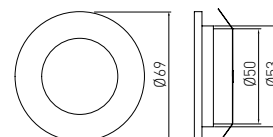

LD-OBP27CB-53	3 x 80 lm	● 2700 K	aluminium, aluminio, Aluminium, aluminij	aluminium + Plastique, aluminio + plastico, Aluminium + Kunststoff, aluminij + plastika	5908231374127
LD-OBP27ZB-53		● 6400 K			5908231374134



FR Ensemble de luminaires  
ES Conjunto de focos  
DE Leuchtenset  
HR Set LED svjetiljki

## MARBELLA

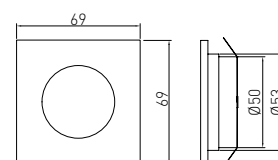

LD-KWP27CB-53	3 x 80 lm	● 2700 K	aluminium, aluminio, Aluminium, aluminij	aluminium + Plastique, aluminio + plastico, Aluminium + Kunststoff, aluminij + plastika	5908231374103



FR Luminaire sur bras  
ES Luminaria para muebles altos  
DE Schrankaufbauleuchte  
HR LED svjetiljka s nosačem

## RADIUS II

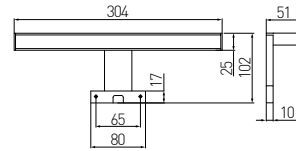

LD-RA60CB-40N	220 lm	● 3000 K	chrome, cromado, Chrom, krom	Plastique, plastique, Kunststoff, plastika
LD-RA60ZB-40N		● 6000 K		
5902801234699				



FR Luminaire LED sans fil  
ES Luminaria LED inalámbrica  
DE Kabellose LED-Leuchte  
HR LEd svjetiljka s akumulatorom

## COMA



LD-IRUSB-53

LD-PIRUSB-53

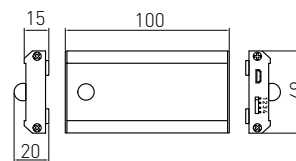

Câble USB supplémentaire de 0,5 m (pour charge)  
Cable USB adicional (para cargar) - 0,5 m incluido  
USB-Kabel (zum Laden) 0,5 m ist im Lieferumfang enthalten.  
Kabel USB (za punjenje) - 0,5 m u kompletu

LD-IRUSB-53	40-50 lm	● 4000 K	INFO	aluminium, aluminio, Aluminium, aluminij
LD-PIRUSB-53			<p>Capteur de proximité IR, 1 ou 2 pôles Detector de proximidad IR, simple o doble Näherungsschalter IR (2 Funktionen: Bewegungsschalter und Schranktür-Schalter) Senzor za blizinu IR, jedno- ili dvosmjerni</p> <p>Capteur de proximité IR, 1 pôle Detector de movimiento PIR, simple Bewegungs- und Präsenzsensoren PIR Schranktür-Schalter, Senzor pokreta PIR, jednosmjerni</p>	
5901867188182				
5901867188199				



FR Lampe  
ES Lámpara  
DE Lämpchen  
HR LED svjetiljka

## BOSTON

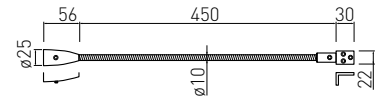

Nécessite alimentation 12 V, 6 W  
Requiere adaptador de 12 V, 6 W  
Netzteil 12 V, 6 W erforderlich  
Zahtijeva napajanje 12 V, 6 W

LD-BOS1CBWG-53	90 lm	3000 K	aluminium, aluminio, Aluminium, aluminij	aluminium + acier + Plastique, aluminio + acero + plastico, Aluminium + Stahl + Kunststoff, aluminij + čelik + plastika	5902801002915



FR Clip d'étagère pour LED  
ES Klipsy LED do pótek  
DE LED-Clip  
HR LED kopča za police

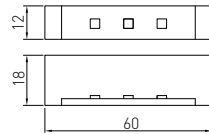

LD-KLPCB-00N  
LD-KLPNB-00N  
LD-KLPZB-00N

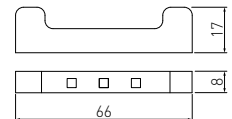
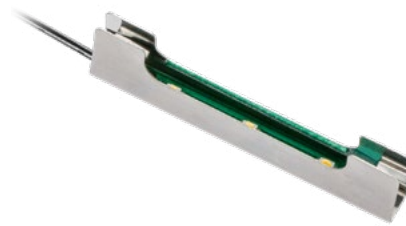

LD-3SKL-ZBN

LD-KLPCB-00N	10 lm	3000 K	Plastique, plastico, Kunststoff, plastika	5901867188205
LD-KLPNB-00N	-	bleu, azul, blau, plava		5901867173997
LD-KLPZB-00N	12 lm	6400 K		5901867187734
LD-3SKL-ZBN	12 lm	6400 K	Metall, Metall, Metall, metal	5901867175212





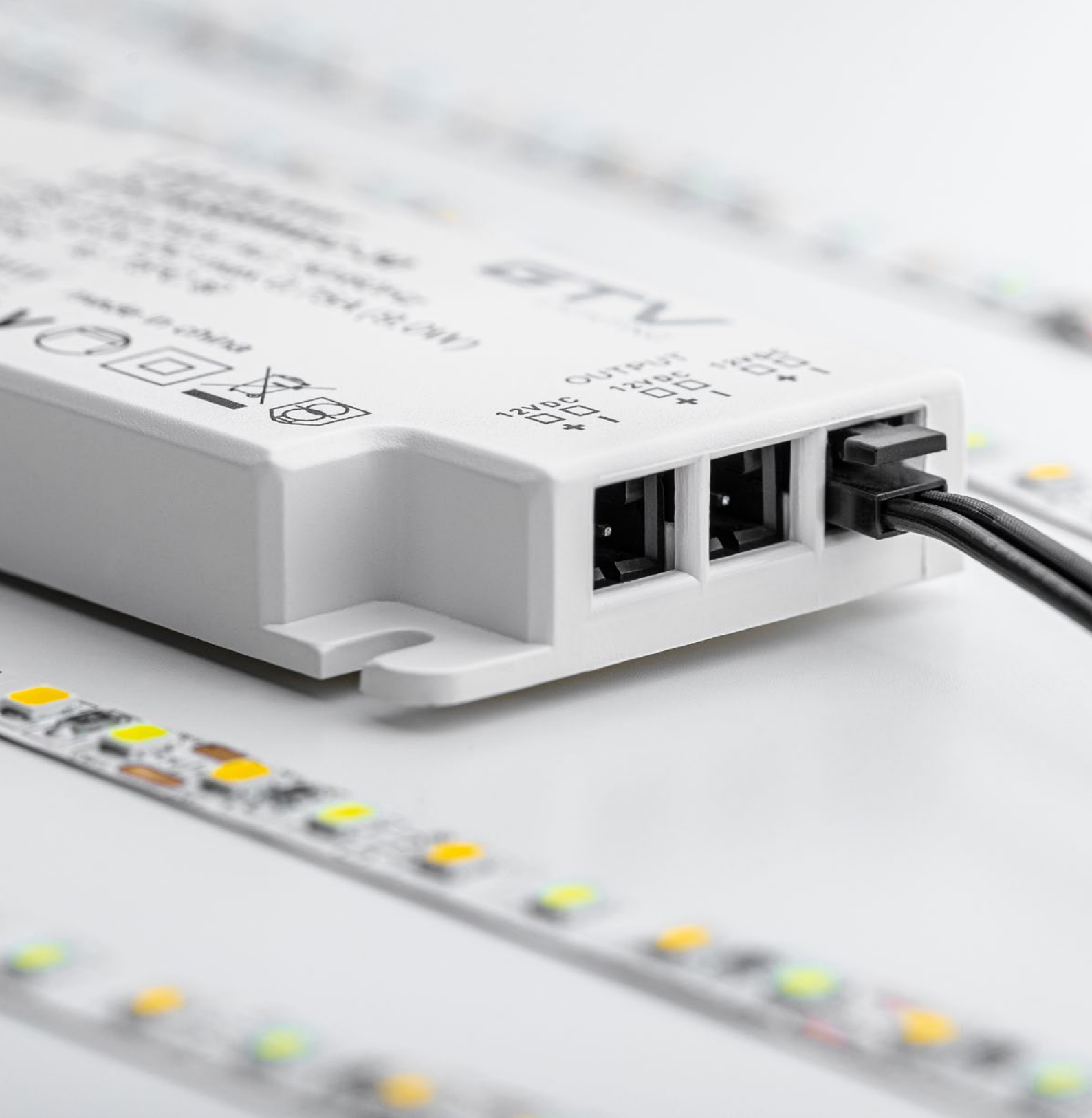

ACCESSOIRES  
ACCESORIOS  
ZUBEHÖR  
DODATNA OPREMA

FR Alimentation LED EASY CLICK  
 ES Fuente de alimentación LED EASY CLICK  
 DE LED-Netzteile EASY CLICK  
 HR LED napajanje EASY CLICK

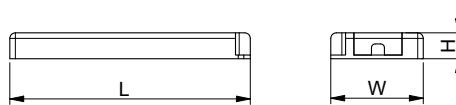

	max	i	A	LxWxH mm			
LD-ZAS09WEC-30	9 W	3 miniAMP	0,75 A	103 x 41 x 12mm	Plastique, plastico, Kunststoff, plastika	110 g	5902801360664
LD-ZAS15WEC-30	15 W	4 miniAMP	1,25 A	129 x 42 x 16 mm		130 g	5902801361876
LD-ZAS20WEC-30	20 W		1,67 A	129 x 42 x 16 mm		140 g	5902801369872
LD-ZAS30WEC-30	30 W	6 miniAMP	2,5 A	160 x 50 x 18 mm		190 g	5902801370038
LD-ZAS60WEC-30	60 W		5 A	190 x 62 x 21 mm		290 g	5902801369995



FR Alimentation LED  
 ES Fuente de alimentación LED  
 DE LED-Netzteile  
 HR LED napajanje

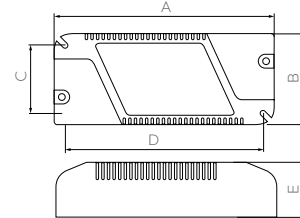

LD-ZAS75W-30	max 75 W	180 x 52 x 42 x 176 x 30	Plastique, plastico, Kunststoff, plastika	350 g	5901867141477



FR Alimentation LED 24V  
 ES Fuente de alimentación LED 24V  
 DE LED-Netzteile 24 V  
 HR LED napajanje 24V

**NEW**

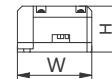
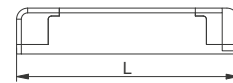

LD-ZAS24PRO80W-30	80 W	181 x 63 x 40 mm	Plastique, plastico, Kunststoff, plastika	300 g	5902801237409
LD-ZAS24PRO16W-30	16 W				5902801367120
LD-ZAS24PRO33W-30	33 W				5902801327179
LD-ZAS24PRO54W-30	54 W				5902801327186



FR Système d'alimentation  
ES Sistema de alimentación  
DE Stromversorgungssystem  
HR Napajački set

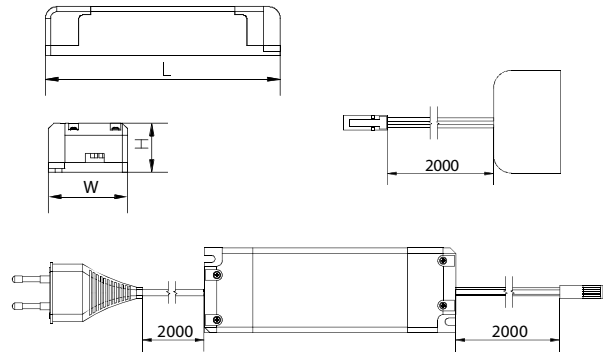

LD-ZZAS07PROKD6	7 W	100 x 39 x 25	Plastique, plastico, Kunststoff, plastika	5902801246180
LD-ZZAS12PROKD6	12 W	120 x 42 x 27		5902801246364
LD-ZZAS16PROKD6	16 W	120 x 42 x 27		5902801245848
LD-ZZAS24PROKD6	24 W	140 x 47 x 29		5902801246203
LD-ZZAS33PROKD6	33 W	155 x 53 x 30		5902801231087



FR Alimentation LED PRO  
ES Fuente de alimentación LED PRO  
DE LED PRO-Netzteile  
HR LED PRO napajanje

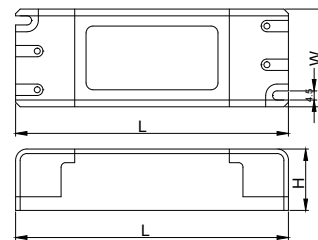

LD-ZASPRO07W-30	7 W	100 x 39 x 25 mm	Plastique, plastico, Kunststoff, plastika	56g	5902801208331
LD-ZASPRO12W-30	12 W	120 x 42 x 27 mm		82 g	5902801207952
LD-ZASPRO16W-30	16 W	120 x 42 x 27 mm		82 g	5902801207983
LD-ZASPRO24W-30	24 W	140 x 47 x 29 mm		109 g	5902801208270
LD-ZASPRO33W-30	33 W	140 x 47 x 29 mm		150 g	5902801251702
LD-ZASPRO54W-30	54 W	155 x 53 x 30 mm		173 g	5902801207976
LD-ZASPRO65W-30	65 W	181 x 63 x 40 mm		281 g	5902801207969
LD-ZASPRO80W-30	80 W	181 x 63 x 40 mm		290g	5902801208010





FR Alimentation LED  
 ES Fuente de alimentación LED  
 DE LED-Netzteile  
 HR LED napajanje

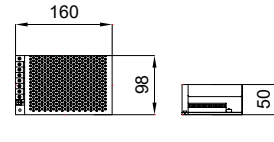

LD-ZAS150-NW	max 150 W	160 x 98 x 50	aluminium, aluminio, Aluminium, aluminij	347 g	5901867128829



FR Alimentation LED  
 ES Fuente de alimentación LED  
 DE LED-Netzteile  
 HR LED napajanje

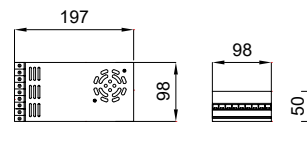

LD-ZAS350-NW	max 350 W	197 x 98 x 50	aluminium, aluminio, Aluminium, aluminij	589 g	5901867128843



FR Alimentation LED  
ES Fuente de alimentación LED  
DE LED-Netzteile  
HR LED napajanje

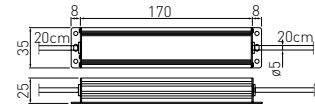

LD-WZA20W-NW

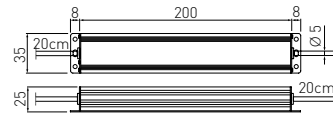

LD-WZA36W-NW

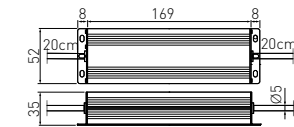

LD-WZA60W-NW

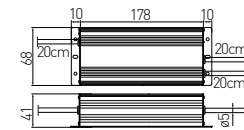

LD-WZA80W-NW

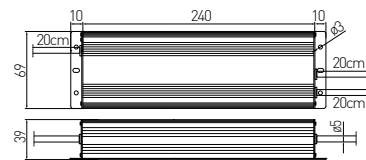

LD-WZA150W-NW

Icon	Power (W)	Weight (g)	Barcode
LD-WZA20W-NW	20 W	170 g	5901867128720
LD-WZA36W-NW	36 W	310 g	5901867128744
LD-WZA60W-NW	60 W	990 g	5901867128768
LD-WZA80W-NW	80 W	1000 g	5901867128782
LD-WZA150W-NW	150 W	2000 g	5901867128805



FR Boitier d'alimentation LED  
ES Fuente de alimentación LED redonda  
DE LED-Netzgerät für Montagedosen  
HR LED napajanje

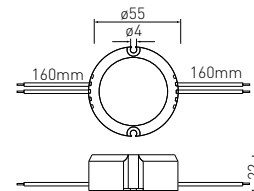

Folder icon	Power (W)	Material	Barcode
LD-ZASPU15W-30N	15 W	Plastique, plastico, Kunststoff, plastika	5902801020094



FR Système d'alimentation pour clips LED 5 points  
 ES Sistema de alimentación para clips LED, de 5 puntos  
 DE Stromversorgungssystem für 5-Punkt-LED-Clips  
 HR Napajački set za LED klipove 5-točki

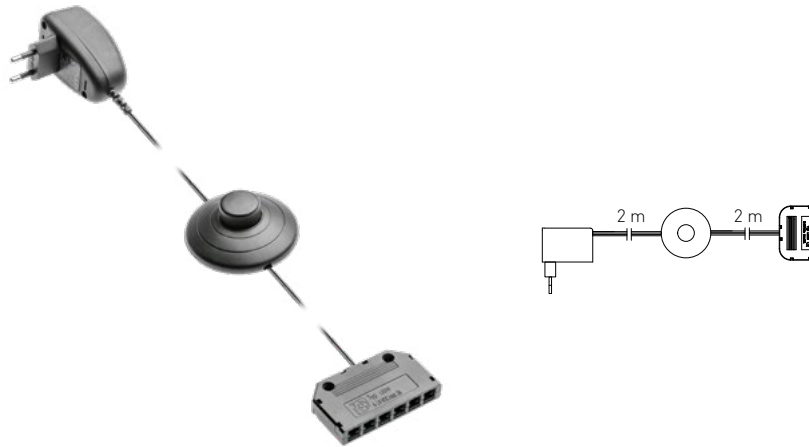

LD-ZSKL15-00N	5 x mini AMP	Plastique, plastico, Kunststoff, plastika	5902801270970
LD-ZZASG18KWD6	6 x mini AMP		5902801294884



FR Système d'alimentation  
 ES Sistema de alimentación  
 DE Stromversorgungssystem  
 HR Napajački set

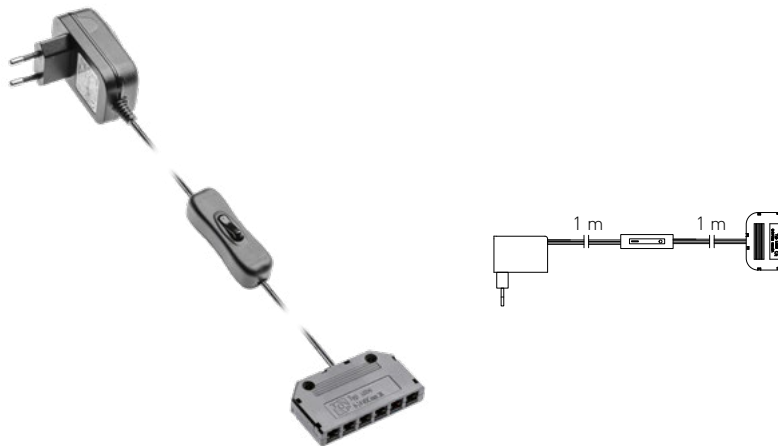

LD-ZWND6W-10	max 6 W	Plastique, plastico, Kunststoff, plastika	5908231335753
LD-ZWND12-10	max 12 W		5908231336675



FR Kit RGB - contrôleur, alimentation 6W LED, télécommande et distributeur  
 ES Conjunto RGB: controlador, fuente de alimentación LED 6W, mando a distancia y distribuidor  
 DE RGB-Set, Steuergerät, 6W LED-Netzteil, Fernbedienung und Verteiler  
 HR RGB set - kontroler, LED papiranje 6W, daljinski upravljač i distributer



LD-ZAC6WDE-RGB	RGB	Plastique, plastico, Kunststoff, plastika	5908231399663
----------------	-----	---	---------------



FR Contrôleur RGB mini avec télécommande  
 ES Controlador RGB mini con control a distancia  
 DE RGB-Mini-Controller mit Fernbedienung  
 HR RGB kontroler mini sa daljinskim upravljačem



LD-KONMINI-RGB	RGB	Plastique, plastico, Kunststoff, plastika	5908231384676
----------------	-----	---	---------------





FR Contrôleur 1 zone MONO  
ES Controlador de 1 zona MONO  
DE 1-Zonen Controller MONO  
HR 1-zonski kontroler MONO

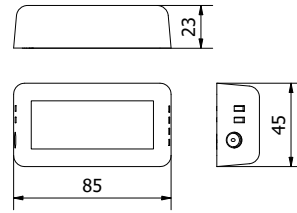

LD-KONML-MONO	MONO	Plastique, plastico, Kunststoff, plastika	5902801200151
---------------	------	---	---------------



FR Télécommande à 4 zones MONO  
ES Mando a distancia de 4 áreas MONO  
DE 4-Zonen Fernbedienung MONO  
HR 4-zonski daljinski upravljač MONO

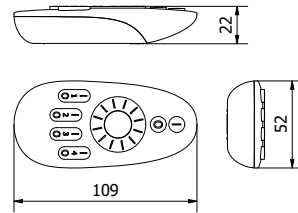

LD-KONML-MONO-PIL	Plastique, plastico, Kunststoff, plastika	5902801200502
-------------------	---	---------------



FR Écran tactile à 4 zones alimenté par batterie MONO  
ES Panel táctil de 4 áreas a pilas MONO  
DE 4-Zonen Berührungspanel, batteriebetrieben MONO  
HR 4-zonski upravljački panel sa baterijama MONO

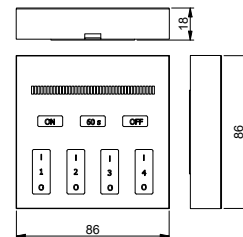

LD-KONML-MONO-PAN	Plastique, plastico, Kunststoff, plastika	5902801200571
-------------------	---	---------------



FR Contrôleur 1 zone RGBW  
ES Controlador de 1 zona RGBW  
DE 1-Zonen Controller RGBW  
HR 1-zonski kontroler RGBW

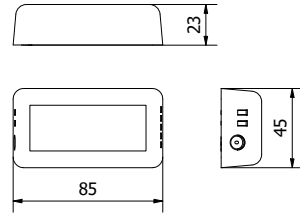

LD-KONML-RGBW	RGBW	Plastique, plastico, Kunststoff, plastika	5902801200519
---------------	------	---	---------------



FR Télécommande à 4 zones RGBW  
ES Mando a distancia de 4 áreas RGBW  
DE 4-Zonen Fernbedienung RGBW  
HR 4-zonski daljinski upravljač RGBW

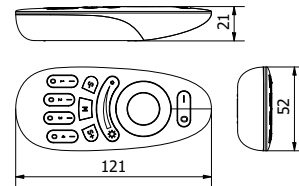

LD-KONML-RGBW-PIL	RGBW	Plastique, plastico, Kunststoff, plastika	5902801200380
-------------------	------	---	---------------



FR Écran tactile à 4 zones alimenté par batterie RGBW  
ES Panel táctil de 4 áreas a pilas RGBW  
DE 4-Zonen Berührungspanel, batteriebetrieben RGBW  
HR 4-zonski upravljački panel sa baterijama RGBW

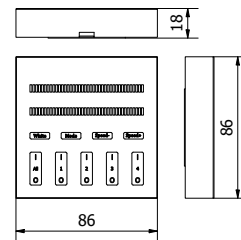
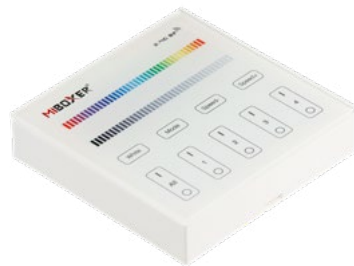

LD-KONML-WRGB-PAN	RGBW	Plastique, plastico, Kunststoff, plastika	5902801200489
-------------------	------	---	---------------



FR Contrôleur WiFi  
 ES Controlador WiFi  
 DE WiFi-Controller  
 HR WiFi kontroler

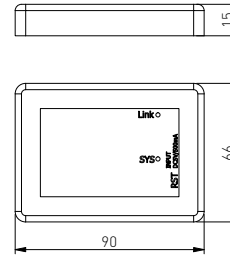

LD-KONML-WIFI	RGB	Plastique, plastico, Kunststoff, plastika	5902801200588
---------------	-----	---	---------------



FR Adaptateur de télécommande  
 ES Adaptador para mando a distancia  
 DE Adapter für Fernbedienung  
 HR Zidni nosač za daljinski upravljač

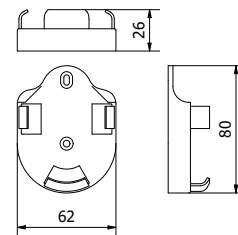

LD-KONML-AD	Blanc, blanco, weiß, bijeli	Plastique, plastico, Kunststoff, plastika	5902801200700
-------------	-----------------------------	---	---------------



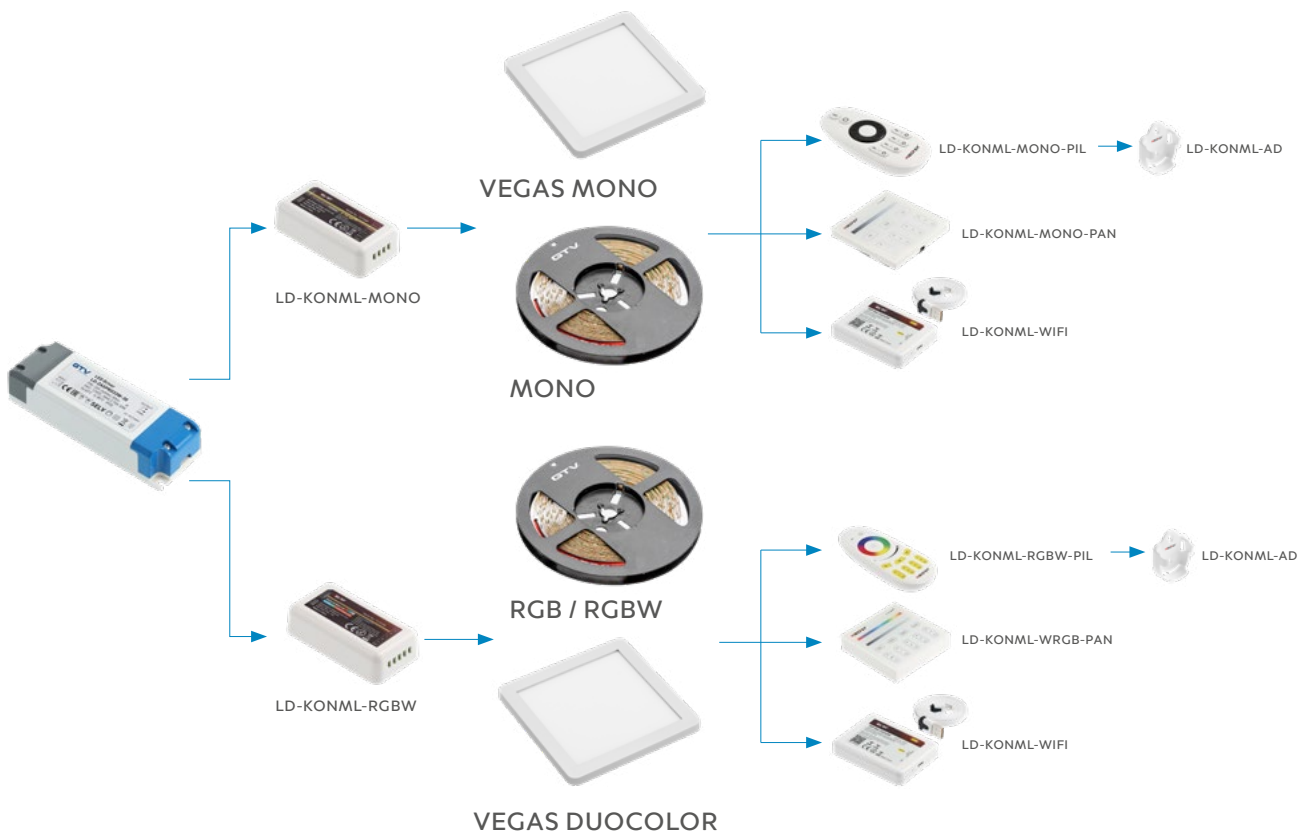



FR Interrupteur sans contact sans fil on-off  
 ES Interruptor táctil inalámbrico on-off  
 DE Kabelloser Berührungsschalter on-off  
 HR Bežični dodirni prekidač on-off



White

Black

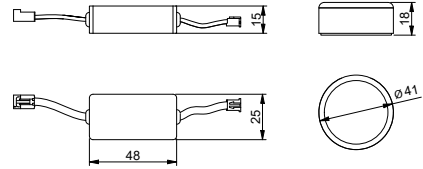

AE-WDBP1-10 N	Blanc, blanco, weiß, bijeli	Plastique, plastico, Kunststoff, plastika	5902801330919
AE-WDBP1-20 N	noir, negro, schwarz, crna		5902801330926



FR Interrupteur sans contact sans fil CCT  
 ES Interruptor táctil inalámbrico CCT  
 DE Kabelloser Berührungsschalter CCT  
 HR Bežični dodirni prekidač CCT

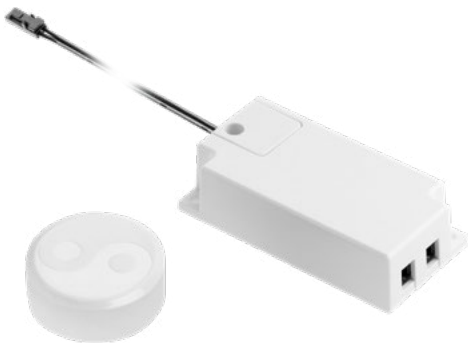

White

Black

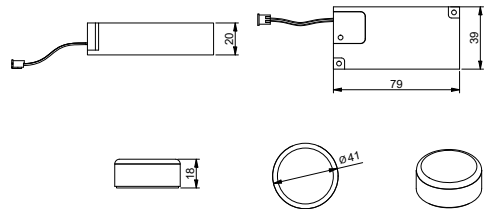

AE-WDBP2CCT-10N	Blanc, blanco, weiß, bijeli	Plastique, plastico, Kunststoff, plastika	5902801330971
AE-WDBP2CCT-20N	noir, negro, schwarz, crna		5902801331107





FR Interrupteur de proximité  
 ES Interruptor sin contacto  
 DE Berührungsloser Schalter  
 HR Beskontaktni prekidač

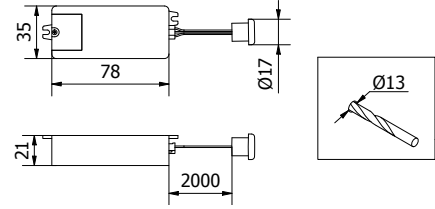

	INFO		
AE-WBEZDC-10S	bipolaire, modo táctil, Bewegungsschalter, dvije brzine	Plastique, plastico, Kunststoff, plastika	5901867160348
AE-WBEZDB-10S*	unipolaire, modo puerta, Schranktür-Schalter, jedna brzina		5901867160324



FR Interrupteur tactile sous la vis  
 ES Interruptor táctil para el tornillo  
 DE Berührungsschalter, zum Anschließen an Metallgegenstände  
 HR Prekidač na dodir

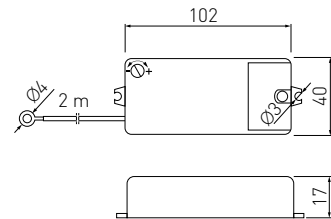

AE-WBEZDK15-10	Plastique, plastico, Kunststoff, plastika	5902801032110



FR Interrupteur avec détecteur de mouvement à infrarouge PIR  
 ES Interruptor con detector de movimiento PIR  
 DE Schalter mit Bewegungsmelder PIR  
 HR Prekidač s PIR senzorom pokreta

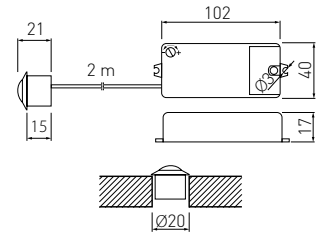

AE-WBEZDPIR-10	Plastique, plastico, Kunststoff, plastika	5902801032141
----------------	---	---------------



FR Interrupteur avec deux détecteurs de mouvement PIR  
 ES Interruptor con dos detectores de movimiento PIR II  
 DE Schalter mit zwei Bewegungsmeldern PIR II  
 HR Prekidač s dva senzora pokreta PIR II

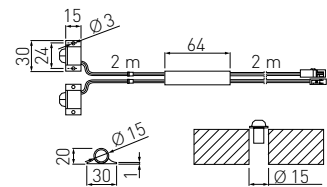

AE-WBEZDPIR2-20	Plastique, plastico, Kunststoff, plastika	5902801032639
-----------------	---	---------------





FR Interrupteur de proximité universel 3 en 1  
 ES Interruptor sin contacto universal 3 en 1  
 DE 3-in-1 universeller berührungsloser Schalter  
 HR Bezkontaktni prekidač univerzalni 3 u 1

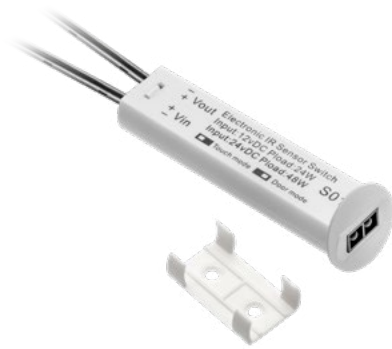

White

Black

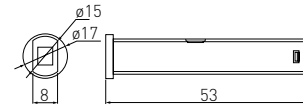

AE-WBBUNI-10DIM	Blanc, blanco, weiß, bijeli	Plastique, plastico, Kunststoff, plastika	5901867158338
AE-WBCUNI-10DIM	noir, negro, schwarz, crna		5901867158352



FR Interrupteur de proximité, micro  
 ES Interruptor sin contacto, micro  
 DE Berührungsloser Schalter, Mikro  
 HR Beskontaktni prekidač, mikro

**NEW**

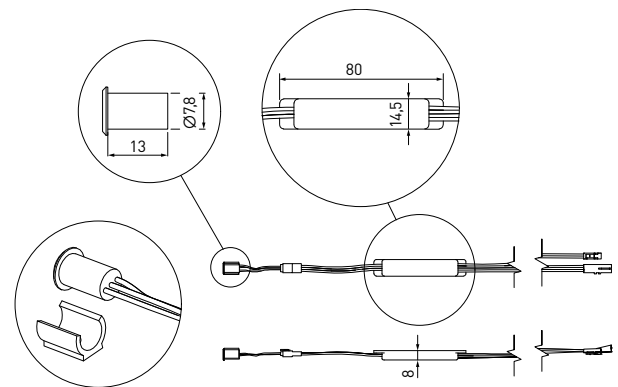

AE-WBE1-20	noir, negro, schwarz, crna	Plastique, plastico, Kunststoff, plastika	5902801458859
AE-WBE1-10	Blanc, blanco, weiß, bijeli		5902801458835

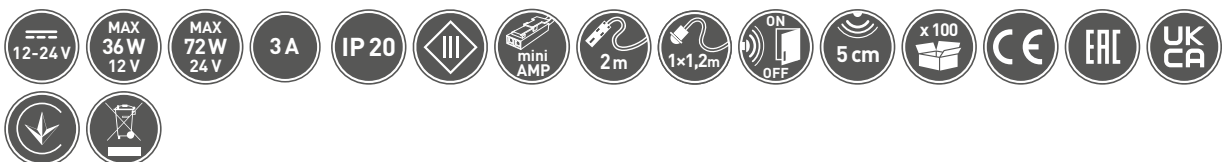

FR Interrupteur de proximité, micro  
 ES Interruptor sin contacto, micro  
 DE Berührungsloser Schalter, Mikro  
 HR Beskontaktni prekidač, mikro

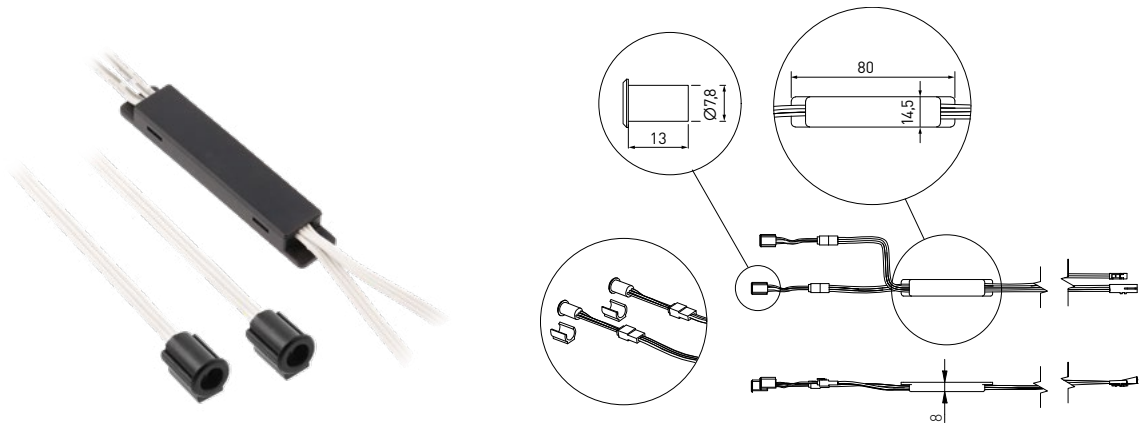

AE-WBE2-20	noir, negro, schwarz, crna	Plastique, plastico, Kunststoff, plastika	5902801458682
AE-WBE2-10	Blanc, blanco, weiß, bijeli		5902801458644



FR Interrupteur tactile gradation  
 ES Interruptor con regulador de intensidad  
 DE Dimmer mit Berührungsschalter  
 HR Prekidač na dodir s regulacijom



White

Black

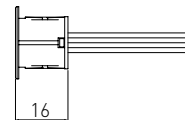

AE-WDSB-10DIM	Blanc, blanco, weiß, bijeli	Plastique, plastico, Kunststoff, plastika	5901867175724
AE-WDSC-10DIM	noir, negro, schwarz, crna		5901867175748



FR Interrupteur tactile gradation  
 ES Interruptor con regulador de intensidad  
 DE Dimmer mit Berührungsschalter  
 HR Prekidač na dodir s regulacijom



AE-WBEZD-NBN	chrome, chrome, cromado, krom, króm	Plastique, plastico, Kunststoff, plastika	5902801367069

FR Interrupteur caché  
 ES Interruptor para montaje bajo esa  
 DE Unterblattschalter  
 HR Prekidač ugradni

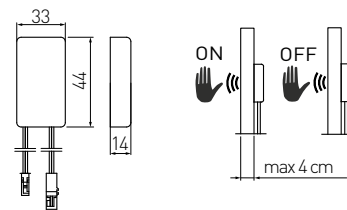
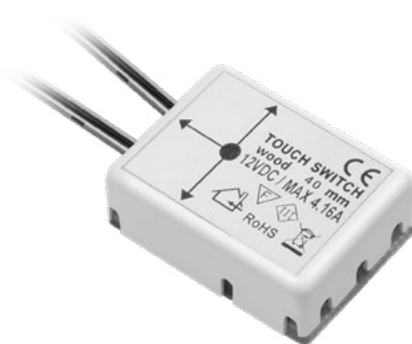

Épaisseur de la plaque max 40 mm  
 Grosor de la encimera máx. 40 mm  
 Plattenstärke max. 40 mm  
 Debljina ploče: 40 mm max

AE-WPDRW-00	Plastique, plastico, Kunststoff, plastika	5901867127167

FR Interrupteur pour rubans LED monté en profilé  
 ES Interruptor para tiras LED, instalado en perfil  
 DE Schalter für LED-Streifen, montiert im Profil  
 HR Prekidač za LED traku

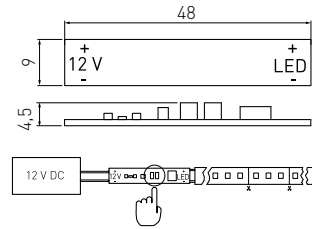

AE-WLPR-60	-	Blanc, blanco, weiß, bijeli	Plaque conductrice, Placa electrónica, Elektronikplatine, Elektronička ploča	1000	5908231398284
AE-WLPR-60P2	2 m			500	5902801022005



FR Interrupteur silencieux  
 ES Interruptor basculante  
 DE Wippschalter  
 HR Pregibni prekidač

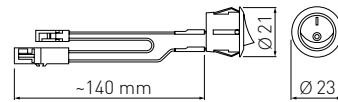

AE-WLB01-10	Blanc, blanco, weiß, bijeli	Plastique, plastico, Kunststoff, plastika	5902801004346
AE-WLC01-20	noir, negro, schwarz, crna		5902801004322





FR Interrupteur rond  
ES Interruptor redondo  
DE Wippschalter rund  
HR Pregibni prekidač



AE-WLIP44-15	Blanc, blanco, weiß, bijeli	Plastique, plastico, Kunststoff, plastika	5901867125071
--------------	-----------------------------	---	---------------



FR Variateur de lumière LED  
ES Atenuador de luz LED  
DE LED-Dimmer  
HR Regulator (dimmer)



## JACKY

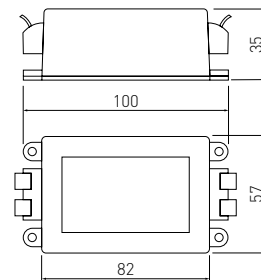

LD-DIMLED-10	noir, negro, schwarz, crna	PC	800 g	5908231337597
--------------	----------------------------	----	-------	---------------



FR Interrupteur à chaîne  
ES Interruptor de cadena  
DE Kettenzugschalter  
HR Potezni prekidač



AE-WLLAN1-10	chrome, cromado, Chrom, krom	Plastique, plastico, Kunststoff, plastika	5908231313942
AE-WLLAN1-90	d'or, de oro, gold, zlato		5901867124548
AE-WLLAN1-20	noir, negro, schwarz, crna		5901867124531



FR Interrupteur à cordon  
ES Interruptor de cable  
DE Zugschalter mit Schnur  
HR Potezni prekidač



AE-WLSZN1-10	noir, negro, schwarz, crna	polypropylène, polipropileno, Polypropylen polipropilen	590823133186



FR Câble d'alimentation avec fiche et interrupteur  
 ES Cable de alimentación con enchufe e interruptor  
 DE Netzkabel mit Stecker und Schalter  
 HR Napajački kabel s utikačem i prekidačem

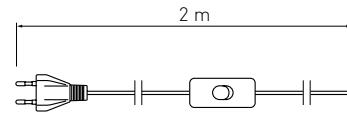

LD-KABE2M-00	Blanc, blanco, weiß, bijeli	Plastique, plastico, Kunststoff, plastika	5908231335265



FR Conduit avec raccords mini AMP  
 ES Conducto con conectores mini AMP  
 DE Kabel mit Mini-AMP-Steckverbindern  
 HR Kabel s mini AMP konektorima

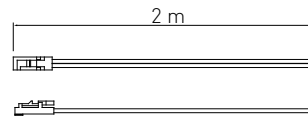

LZ-KA2MM-10	noir, negro, schwarz, crna	Plastique, plastico, Kunststoff, plastika	5901867174161



FR Conduit avec raccords mini AMP  
 ES Cable con conectores mini AMP  
 DE Kabel mit mini AMP-Verbindern  
 HR Kabel s mini AMP konektorima

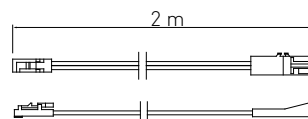

LZ-KAPR2M-10	noir, negro, schwarz, crna	Plastique, plastico, Kunststoff, plastika	5908231335876



FR Raccord pour l'éclairage LED avec distributeur, 3 prises  
 ES Conector para alumbrado LED con distribuidor, 3 entradas  
 DE Verteiler für LED-Beleuchtung, 3-fach  
 HR Mini AMP konektor s distributorom 3 mjesta

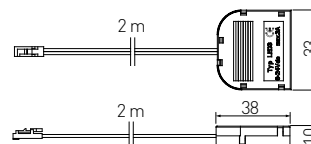

LZ-AKZ312-10N	noir, negro, schwarz, crna	Plastique, plastico, Kunststoff, plastika	5901867174017





FR Raccord pour l'éclairage LED avec distributeur, 6 prises  
 ES Conector para iluminación LED con distribuidor, 6 entradas  
 DE Verteiler für LED-Beleuchtung, 6-fach  
 HR Mini AMP konektor s distributorom 6 mjesta

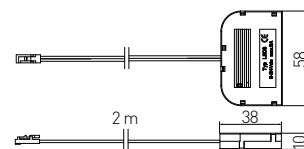

LZ-AKZ612-10N	noir, negro, schwarz, crna	Plastique, plastico, Kunststoff, plastika	5901867187598
---------------	----------------------------	---	---------------



FR Raccord pour rubans LED COB  
 ES Conector para tiras LED COB  
 DE Verbinder für LED-Streifen COB  
 HR Konektori za LED trake COB

**NEW**

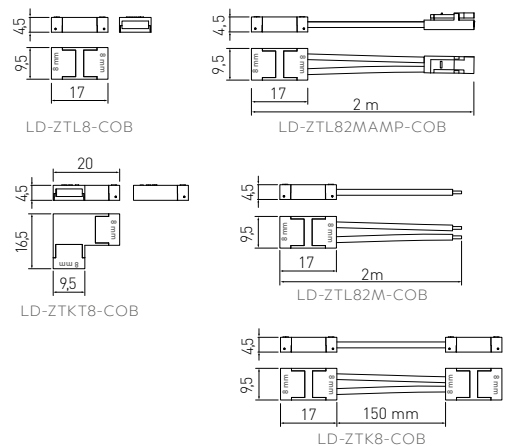

LD-ZTL82MAMP-COB	Plastique, plastico, Kunststoff, plastika	5902801456138
LD-ZTL82M-COB		5902801454325
LD-ZTL8-COB		5902801455612
LD-ZTK8-COB		5902801455841



FR Raccord XC11 pour rubans LED  
 ES Conector XC11 para tiras LED  
 DE Verbinder XC11 für LED-Streifen  
 HR XC11 konektori za LED trake



	INFO		
LD-ZTL8MM-02N600	8 mm / 600 LED	Plastique, plastico, Kunststoff, plastika	5902801001536
LD-ZTL10MM-02N	10 mm		5901867172587
LD-ZTLRGB-04N	RGB		5901867172617



FR Connecteur XC11 pour rubans LED d'angles  
 ES Conector XC11 para tiras LED angular  
 DE Eckverbinder XC11 für LED-Streifen  
 HR XC11 kontakt za LED trake kutni



	INFO		
LD-ZTKT8MM-02N600	8 mm / 600 LED	Plastique, plastico, Kunststoff, plastika	5902801001550
LD-ZTKT10MM-02N	10 mm		5901867172884
LD-ZTKTRGB-04N	RGB		5901867172822



FR Connecteur XC11 pour rubans LED avec 15 cm de câble  
 ES Conector XC11 para tiras LED con cable de 15 cm  
 DE Verbinder XC11 für LED-Streifen 8 mm mit Kabel 15 cm  
 HR XC11 konektori za LED trake s 15 cm kabela

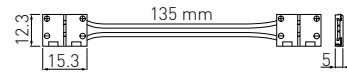

LD-ZTK8MM-02N

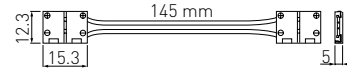

LD-ZTK8MM-02N600

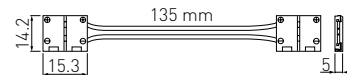

LD-ZTK10MM-02N



INFO



LD-ZTK8MM-02N600	8 mm / 600 LED	Plastique, plastico, Kunststoff, plastika	5902801001543
LD-ZTK10MM-02N	10 mm		5901867172761



FR Raccord XC11 pour rubans LED SLIM  
 ES Conector XC11 para tiras LED SLIM  
 DE Verbinder XC11 für LED-Streifen SLIM  
 HR XC11 konektori za LED trake SLIM

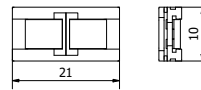

LD-ZTLS8MM-02N

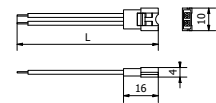

LD-ZTLS82M-2N



LD-ZTKS8MM-02N

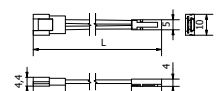

LD-ZTLS8MMAMP-02N



INFO



LD-ZTLS8MM-02N	8 mm	-	Plastique, plastico, Kunststoff, plastika	5902801202377
LD-ZTKS8MM-02N		15 cm		5902801202230
LD-ZTLS82M-2N		200 cm		5902801202391
LD-ZTLS8MMAMP-02N		200 cm + mini amp		5902801205392



FR Chargeur à induction avec alimentation LUX  
 ES Cargador de inducción con alimentación LUX  
 DE Kabelloses Ladegerät LUX mit Trafo  
 HR Indukcijski punjač s napajanjem LUX

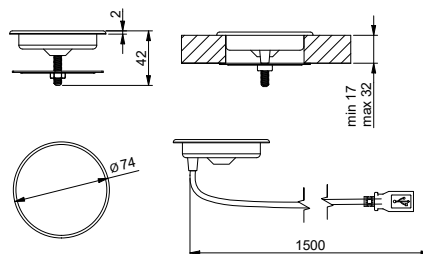

AE-ZLADLUX-40

chrome, cromado, Chrom, krom

Plastique, plastico, Kunststoff, plastika

5902801235153



FR Chargeur sans fil, monté sous le chargeur avec alimentation électrique  
 ES Cargador inalámbrico bajo mesa con fuente de alimentación  
 DE Induktionsladegerät mit Netzteil für Mobiltelefone, Untertischmontage  
 HR Indukcijski punjač s izvorom napajanja ugradni

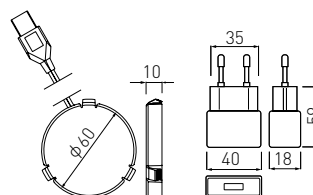

AE-ZLADPOD-20

noir, negro, schwarz, crna

Plastique, plastico, Kunststoff, plastika

5902801031854





FR Chargeur à induction avec alimentation  
 ES Cargador de inducción con alimentación  
 DE Induktionsladegerät mit Netzgerät  
 HR Indukcijski punjač s izvorom napajanja



360°

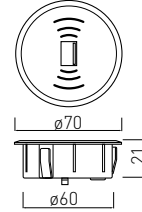

AE-ZUSB-20	noir, negro, schwarz, crna	Plastique, plastico, Kunststoff, plastika	5901867181954
------------	----------------------------	---	---------------





RALLONGE  
ALARGADERA  
VERLÄNGERUNGSKABEL  
UTIČNICE

FR Prise de courant pour meubles encastrée  
 ES Enchufe para muebles empotrado  
 DE Möbel-Einbausteckdose  
 HR Ugradbena utičnica za namještaj

## PRESTINO



AE-PB2FPRES-10



AE-PB2FPRES-20



AE-PB2FPRES-53



AE-PB2SPRES-10



AE-PB2SPRES-20



AE-PB2SPRES-53

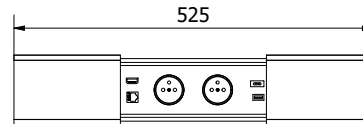
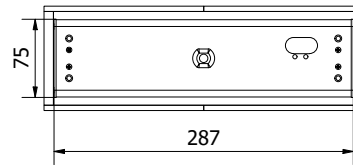
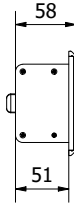
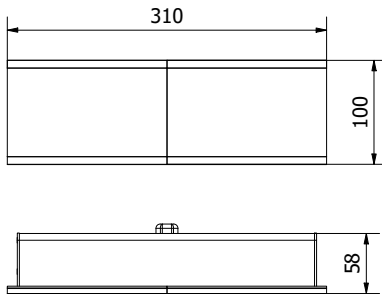

INFO



AE-PB2FPRES-20	USB-A + USB-C DC5V 3A (max 15,0W) DC9V 2A (MAX. 18,0W) DC12V 1.5A (MAX. 18,0W)	2 x french	aluminium, aluminio, Aluminium, aluminij	aluminium + Plastique, aluminio + plastico, Aluminium + Kunststoff, aluminij + plastika	5902801349812
AE-PB2SPRES-20		2 x schuko			5902801349669
AE-PB2FPRES-53		2 x french			5902801355301
AE-PB2SPRES-53		2 x schuko			5902801349829
AE-PB2FPRES-10		2 x french			5902801355295
AE-PB2SPRES-10		2 x schuko			5902801325601





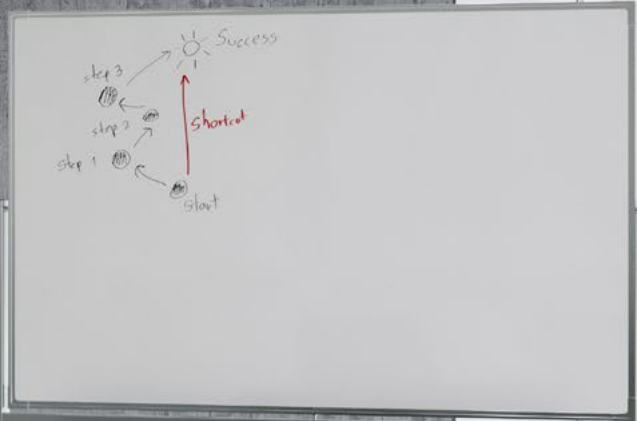



FR Prise de courant pour meubles encastrée  
 ES Enchufe para muebles empotrado  
 DE Möbel-Einbausteckdose  
 HR Ugradbena utičnica za namještaj



## CHARGER PLUS



AE-BPW1FACP-10



AE-BPW1SACP-10

White

Black

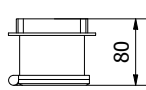
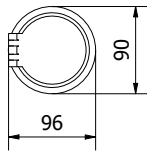

Included



White

Black

	INFO	X			
AE-BPW1FACP-10	USB A+C 5V/2,4A interchangeable: USB A, HDMI, RJ45	1 x french	Blanc, blanco, weiß, bijeli	Plastique, plastico, Kunststoff, plastika	5902801325489
AE-BPW1FACP-20		1 x french	noir, negro, schwarz, crna		5902801354977
AE-BPW1SACP-10		1 x schuko	Blanc, blanco, weiß, bijeli		5902801325519
AE-BPW1SACP-20		1 x schuko	noir, negro, schwarz, crna		5902801355332







## COMFORT PLUS



AE-BPW4F120P-10



AE-BPW4S120P-10

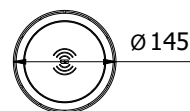
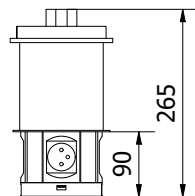

	INFO	X			
AE-BPW4F120P-10	2xUSB 5V/3,1A 2xRJ45	4 x french	Blanc, blanco, weiß, bijeli	Plastique, plastico, Kunststoff, plastika	5902801355172
AE-BPW4F120P-20			noir, negro, schwarz, crna		5902801355288
AE-BPW4S120P-10		4 x schuko	Blanc, blanco, weiß, bijeli		5902801355264
AE-BPW4S120P-20			noir, negro, schwarz, crna		5902801354878











# CAMINO



AE-BPW2FCAM-20



AE-BPW2FCAM-10

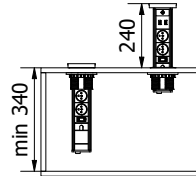
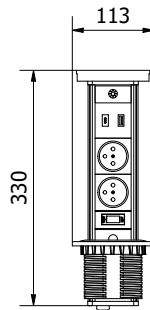

INFO



AE-BPW2FCAM-20	USB-A + USB-C DC5V 3A (max 15,0W) DC9V 2A (MAX. 18,0W) DC12V 1.5A (MAX. 18,0W)	2 x french	noir, negro, schwarz, crna	aluminium + Plastique, aluminio + plastico, Aluminium + Kunststoff, aluminij + plastika	5902801325410
AE-BPW2SCAM-20		2 x schuko			5902801355233
AE-BPW2FCAM-10		2 x french	Blanc, blanco, weiß, bijeli		5902801325533
AE-BPW2SCAM-10		2 x schuko			5902801325656





FR Prise de courant pour meubles encastrée  
 ES Enchufe para muebles empotrado  
 DE Möbel-Einbausteckdose  
 HR Ugradbena utičnica za namještaj



## AVARO PLUS



AE-PB1FAVAP-10

AE-PB1SAVAP-10

White

Black

Grey

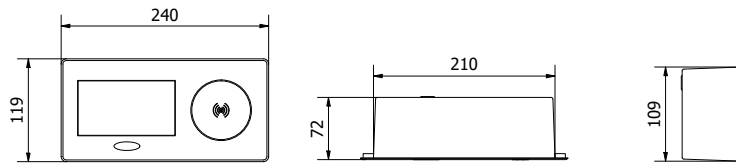

INFO



AE-PB1FAVAP-20	USB-A + USB-C DC5V 3A (max 15,0W) DC9V 2A (MAX. 18,0W) DC12V 1.5A (MAX. 18,0W)	1 x french	noir, negro, schwarz, crna	aluminium + Plastique, aluminio + plastico, Aluminium + Kunststoff, aluminij + plastika	5902801325137
AE-PB1SAVAP-20		1 x schuko			5902801355349
AE-PB1FAVAP-53		1 x french	gris, gris, grau, sivi		5902801325786
AE-PB1SAVAP-53		1 x schuko			5902801326172
AE-PB1FAVAP-10		1 x french	Blanc, blanco, weiß, bijeli		5902801355196
AE-PB1SAVAP-10		1 x schuko			5902801325540









FR Prise de courant pour meubles encastrée  
 ES Enchufe para muebles empotrado  
 DE Möbel-Einbausteckdose  
 HR Ugradbena utičnica za namještaj

# AVARO



AE-PB1FAVA-10



AE-PB1SAVA-10

White

Black

Grey

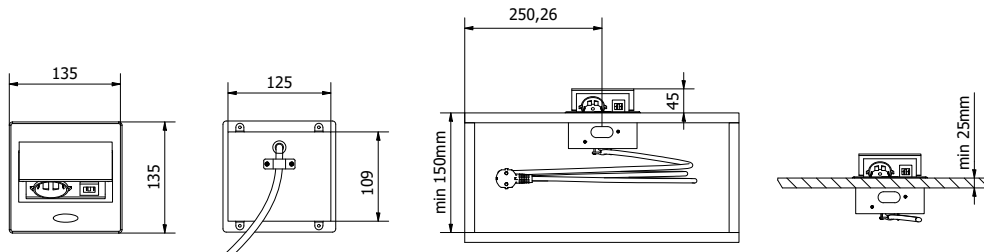

INFO



AE-PB1FAVA-20	USB A DC5V 2A (MAX. 10,0W)	1 x french	noir, negro, schwarz, crna	aluminium + Plastique, aluminio + plastico, Aluminium + Kunststoff, aluminij + plastika	5902801355165
AE-PB1SAVA-20		1 x schuko			5902801349706
AE-PB1FAVA-53		1 x french	gris, gris, grau, sivi		5902801355271
AE-PB1SAVA-53		1 x schuko			5902801349713
AE-PB1FAVA-10		1 x french	Blanc, blanco, weiß, bijeli		5902801355202
AE-PB1SAVA-10		1 x schuko			5902801355189





GTV  
LIGHTING

GTV  
LIGHTING

FR Prise de courant pour meubles encastrée  
 ES Enchufe para muebles empotrado  
 DE Möbel-Einbausteckdose  
 HR Ugradbena utičnica za namještaj

## CHARGER

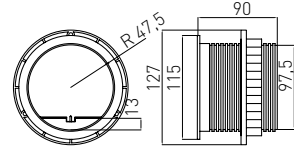

AE-BPW1S2UCH-80	1 x schuko	Argent, plata, silberfarben, srebrni	Plastique, plastico, Kunststoff, plastika	5901867196439
AE-BPW1U2UCH-80	1 x french			5901867196422



FR Prise de courant pour meubles encastrée  
 ES Enchufe para muebles empotrado  
 DE Möbel-Einbausteckdose  
 HR Ugradbena utičnica za namještaj

## CHARGER MINI



AE-BPW1S1UCH-53



AE-BPW1U1UCH-53

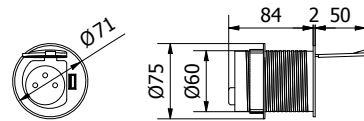

AE-BPW1U1UCH-53	1 x french	aluminium, aluminio, Aluminium, aluminij	Plastique, plastico, Kunststoff, plastika	5902801253065
AE-BPW1S1UCH-53	1 x schuko			5902801253713



FR Prise de courant pour meubles encastrée  
 ES Enchufe para muebles empotrado  
 DE Möbel-Einbausteckdose  
 HR Ugradbena utičnica za namještaj

## SLIDE



AE-BPW1U1UCH-51

AE-BPW1S1UCH-51

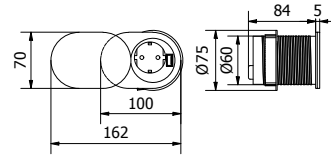

INFO



AE-BPW1U1UCH-51	USB 5V / 2,4A	1 x french	aluminium, aluminio, Aluminium, aluminij	Plastique, plastico, Kunststoff, plastika	5902801253027
AE-BPW1S1UCH-51		1 x schuko			5902801252945



FR Prise de courant pour meubles encastrée  
 ES Enchufe para muebles empotrado  
 DE Möbel-Einbausteckdose  
 HR Ugradbena utičnica za namještaj

## COMFORT



AE-BPW3S100U-53

AE-BPW4U100-53

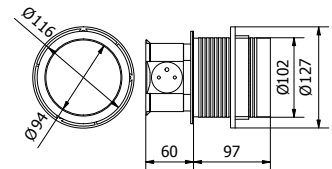

INFO



AE-BPW4U100-53	USB 5V / 2,4A	4 x french	aluminium, aluminio, Aluminium, aluminij	aluminium + Plastique, aluminio + plastico, Aluminium + Kunststoff, aluminij + plastika	5902801252617
AE-BPW4S100-53		4 x schuko			5902801253003
AE-BPW3U100U-53		3 x french			5902801253010
AE-BPW3S100U-53		3 x schuko			5902801252587





FR Prise de courant pour meubles encastrée ronde ø 100  
 ES Enchufe redondo ø 100 empotrado para muebles  
 DE Runde Möbel-Einbausteckdose ø 100  
 HR Okrugla ugradbena utičnica za namještaj ø 100



Black

Silver

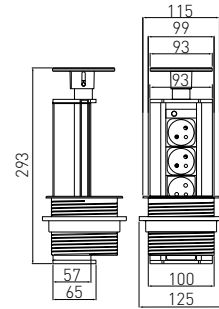

AE-BPW3GU-20	100	3 x french	noir, negro, schwarz, crna	aluminium + Plastique, aluminio + plastico, Aluminium + Kunststoff, aluminij + plastika	5908231338815
AE-BPW3GU-80			noir, negro, schwarz, crna		5908231338808
AE-BPW3GS-20		3 x schuko	noir, negro, schwarz, crna		5908231338839
AE-BPW3GS-80			Argent, plata, silberfarben, srebrni		5908231338822



FR Prise de courant pour meubles encastrée ronde ø 60  
 ES Enchufe redondo ø 60 empotrado para muebles  
 DE Runde Möbel-Einbausteckdose ø 60  
 HR Okrugla ugradbena utičnica za namještaj ø 60



Black

Silver

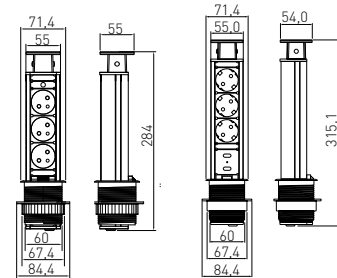

AE-BPW3U60U-20

AE-BPW3U60-80



AE-BPW3U60-20	60	3 x french	-	noir, negro, schwarz, crna	aluminium + Plastique, aluminio + plastico, Aluminium + Kunststoff, aluminij + plastika	5908231395559	
AE-BPW3U60-80				Argent, plata, silberfarben, srebrni		5908231395566	
AE-BPW3S60-20		3 x schuko	-	noir, negro, schwarz, crna		5908231395535	
AE-BPW3S60-80				Argent, plata, silberfarben, srebrni		5908231395542	
AE-BPW3U60U-20		5V USB	3 x french	-		noir, negro, schwarz, crna	5901867130983
AE-BPW3U60U-80						Argent, plata, silberfarben, srebrni	5901867131003
AE-BPW3S60U-20			3 x schuko	-		noir, negro, schwarz, crna	5901867130945
AE-BPW3S60U-80						Argent, plata, silberfarben, srebrni	5901867130969



FR Prise de courant pour meubles encastrée rectangulaire  
 ES Enchufe rectangular empotrado para muebles  
 DE Rechteckige Möbel-Einbausteckdose  
 HR Pravokutna ugradbena utičnica za namještaj

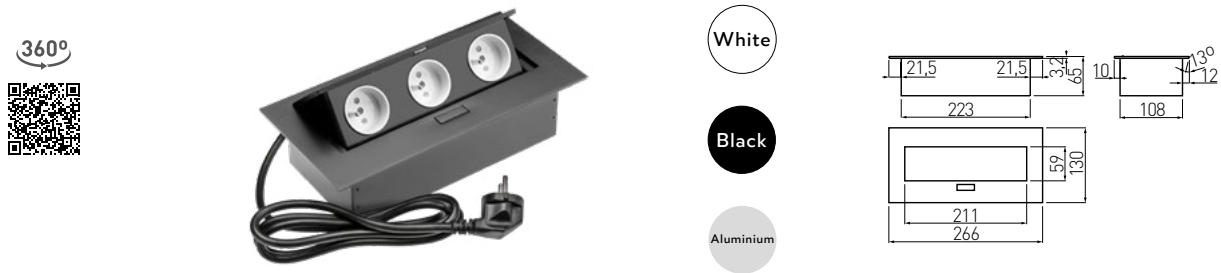

AE-PB03GS-53	-	3 x schuko	aluminium, aluminio, Aluminium, aluminij	acier + Plastique, acero + plastico, Stahl + Kunststoff, čelik + plastika	5908231362605	
AE-PB03GS-20	-	3 x schuko			5901867157089	
AE-PB03GS-10	-	3 x schuko			5901867157096	
AE-PB03GU-53	-	3 x french			5908231337689	
AE-PBC3GU-53	1,5 m	3 x french			5908231389121	
AE-PBC3GU-20	1,5 m	3 x french			noir, negro, schwarz, crna	5902801023385
AE-PBC3GU-10	1,5 m	3 x french			Blanc, blanco, weiß, bijeli	5901867130730



FR Prise de courant pour meubles encastrée rectangulaire  
 ES Enchufe rectangular empotrado para muebles  
 DE Rechteckige Möbel-Einbausteckdose  
 HR Pravokutna ugradbena utičnica za namještaj



AE-PBU02GS-10	2 x schuko	Blanc, blanco, weiß, bijeli	acier + Plastique, acero + plastico, Stahl + Kunststoff, čelik + plastika	5901867157072	
AE-PBU02GS-20		noir, negro, schwarz, crna		5901867157065	
AE-PBU2GU-10	2 x french	Blanc, blanco, weiß, bijeli		5901867131010	
AE-PBU2GU-20		noir, negro, schwarz, crna		5901867131034	
AE-PBU2GU-53		aluminium, aluminio, Aluminium, aluminij		5902801265723	



FR Prise de courant pour meubles encastrée  
 ES Enchufe para muebles empotrado  
 DE Möbel-Einbausteckdose  
 HR Ugradbena utičnica za namještaj

**SOFT**



White

Black

Aluminium

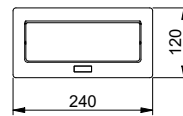

AE-PBSC3GS-10			Blanc, blanco, weiß, bijeli	acier + Plastique, acero + plastico, Stahl + Kunststoff, čelik + plastika	5902801252129
AE-PBSC3GS-20N	3 x schuko		noir, negro, schwarz, crna		5902801281730
AE-PBSC3GS-53			aluminium, aluminio, Aluminium, aluminij		5902801252167
AE-PBSC3GU-10			Blanc, blanco, weiß, bijeli		5902801252242
AE-PBSC3GU-20N	3 x french		noir, negro, schwarz, crna		5902801281716
AE-PBSC3GU-53			aluminium, aluminio, Aluminium, aluminij		5902801251955
AE-PBSUC2GS-10		5V USB max 2A	Blanc, blanco, weiß, bijeli		5902801252259
AE-PBSUC2GS-20N	2 x schuko		noir, negro, schwarz, crna		5902801281693
AE-PBSUC2GS-53			aluminium, aluminio, Aluminium, aluminij		5902801252235
AE-PBSUC2GU-10			Blanc, blanco, weiß, bijeli	5902801252440	
AE-PBSUC2GU-20N	2 x french		noir, negro, schwarz, crna	5902801281761	
AE-PBSUC2GU-53			aluminium, aluminio, Aluminium, aluminij	5902801252815	







FR Prise de courant pour meubles à traversée avec USB  
 ES Enchufe para muebles con USB  
 DE Durchgehende Möbelsteckdose mit USB  
 HR Utičnica za namještaj s USB-om i otvorom za kabel

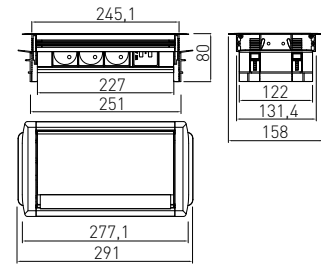

AE-PBC3GS-53BKS	3 x schuko	-	aluminium, aluminio, Aluminium, aluminij	aluminium + Plastique, aluminio + plastico, Aluminium + Kunststoff, aluminij + plastika	5901867196637
AE-PBC3GS2U-53BKS	3 x schuko	5V USB max 2A			5901867196651



FR Prise de courant pour meubles sans cassette  
 ES Enchufe para muebles sin caja  
 DE Möbelsteckdose ohne Gehäuse  
 HR Utičnica za namještaj bez okvira

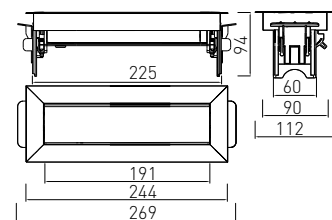

AE-PBC3GS-51BK	3 x schuko	acier brossé, acero pulido, Edelstahloptik, brušeni čelik	acier + Plastique, acero + plastico, Stahl + Kunststoff, čelik + plastika	5901867196613
AE-PBC3GU-51BK	3 x french			5901867196620



FR Prise de courant pour meubles d'angle  
 ES Enchufe para muebles de esquina  
 DE Eck-Möbelsteckdose  
 HR Kutna utičnica za namještaj



AE-PBKT4S-80

AE-PBKT3U2U-80

AE-PBKT4U-80	4 x french	-	5V USB max 2A	Argent, plata, silberfarben, srebrni	aluminium + Plastique, aluminio + plastico, Aluminium + Kunststoff, aluminij + plastika	5901867162779
AE-PBKT4S-80	4 x schuko					5901867162786
AE-PBKT3U2U-80	3 x french	5901867162793				
AE-PBKT3S2U-80	3 x schuko	5901867162809				



## Guide des symboles du catalogue | Catálogo de símbolos | Beschreibung der Symbole | Vodič za simbole u katalogu |

### Ícônes électricas | Iconos electrotécnicos | Elektrotechnische Symbole | Elektrotehnički simboli



Équivalent en watts  
Potencia equivalente  
Äquivalenzleistung  
Ekvivalent snage



Angle de faisceau  
Ángulo de iluminación  
Strahlungswinkel  
Kut svjetlosti



Courant  
Corriente nominal  
Lampenstrom  
Jakost struje



Marquage de protection international  
Clase de protección IP  
Schutzart IP  
Stupanj zaštite IP



Puissance de la lampe / de l'appareil  
Fuerza de la fuente de iluminación o del aparato  
Leistung der Lichtquelle oder des Gerätes  
Snaga izvora svjetlosti ili uređaja



Durée de vie nominale  
Duración  
Betriebszeit  
Nominalni broj radnih sati



Flux lumineux  
Haz de luz  
Lichtstrom  
Svjetlosni tok



Longueur du fil  
Longitud del cable  
Kabellänge  
Dužina kabela



Longueur du produit  
Longitud del producto  
Produktlänge  
Dužina proizvoda



Longueur du câble avec fiche  
Longitud del cable con clavija  
Länge des Kabels mit Stecker  
Dužina kabela s utikačem



Matériau du boîtier du produit  
Material de la carcasa del producto  
Material des Produktgehäuses  
Materijal kućišta proizvoda



Longueur du ruban LED  
Longitud tira LED  
Länge des LED-Strips  
Dužina LED trake



Couleur du boîtier  
Color de la carcasa  
Gehäusefarbe  
Boja kućišta



Degré de protection IK  
Clase de protección IK  
Schutzart IK  
Stupanj zaštite IK



Température de couleur  
Temperatura del color de la luz  
Farbtemperatur des Lichts  
Temperatura boje svjetla



Poids  
Peso  
Gewicht  
Težina



Connection maximum en ligne d'unités  
Número máximo de focos a conectar en línea  
Maximale Anzahl der Leuchten, die in einer Linie  
angeschlossen werden können  
Maksimalna količina svjetiljki spojenih u liniju



Type de connecteur  
Tipo de conector  
Steckverbindertyp  
Tip konektora



Classe d'efficacité énergétique  
Clase energética  
DE Energieeffizienzklasse  
Energetska klasa



Indice de rendu des couleurs  
Indicador fidelización color  
Farbwiedergabeindex  
Indeks uzvrata boje



Tension  
Alimentación  
Stromversorgung  
Napajanje



Facteur de puissance  
Indicador factor de potencia  
Leistungsfaktor  
Faktor snage



Alimentation 12V DC  
Alimentación a 12 V corriente continua  
Stromversorgungsspannung von 12 V DC  
Napajanje naponom 12 V DC



Facteur d'éblouissement  
Indicador factor deslumbramiento  
Blendungskennzahl  
Faktor blještanja



Tension de sortie  
Tensión de salida  
Ausgangsspannung  
Izlazni napon



Temps d'initialisation  
Tiempo de encendido  
Einschaltzeit  
Vrijeme uključenja



Charge maximale admissible  
Carga máxima admisible  
Maximale zulässige Belastung  
Maksimalno dopušteno opterećenje



Cycles de commutation  
Número de ciclos encendido/apagado  
Anzahl der Zyklen EIN / AUS  
Broj ciklusa on/off



Dimmable  
Funciona con reguladores de intensidad  
Für Dimmerbetrieb geeignet  
Kompatibilan s dimerima



Non dimmable  
No funciona con reguladores de intensidad  
Nicht für Dimmerbetrieb geeignet  
Nije kompatibilan s dimerima



Types de diodes LED  
Tipo de diodo LED  
LED-Typ  
Vrsta diode LED



Nombre de diodes LED  
Número de diodos LED  
Anzahl der LEDs  
Količina dioda LED



Température de travail admissible  
Temperatura de trabajo admisible  
Zulässige Betriebstemperatur  
Dopuštena temperatura rada



Type de tube fluorescent  
Tipo de fluorescente  
Typ der Leuchtstofflampe  
Vrsta cijevi



Section de fil  
Sección del cable  
Kabelquerschnitt  
Presjek kabela



Portée du capteur de mouvement  
Longitud máxima de la señal del detector de movimiento  
Reichweite des Bewegungsmelders  
Maksimalni raspon detekcije senzora pokreta



Angle du détecteur de mouvement  
Ángulo de visión del detector de movimiento  
Erfassungswinkel des Bewegungsmelders  
Kut dometa senzora pokreta



Teneur en mercure  
Contenido de mercurio  
Quecksilbergehalt  
Sadržaj žive



Prise Schuko  
Toma Schuko  
Schuko-Steckdose  
Utičnica Schuko



Prise French  
Toma Francésa  
Steckdosen-Typ E  
Utičnica French



USB  
USB  
USB-Buchse  
USB



Chargement USB  
Carga USB  
USB-Aufladung  
Punjenje preko USB



Charge max port USB  
Máxima carga toma USB  
Maximale Belastung des USB-Anschlusses  
Maksimalno opterećenje USB



Prise UK  
Toma UK  
Britische Steckdose  
Utičnica UK



Luminaire avec interrupteur  
Dispositivo con interruptor  
Gerät mit Schalter  
Svjetiljka s prekidačem



interrupteur thermique  
Interruptor térmico  
Thermoschutzschalter  
Termički prekidač



Distance de montage recommandée par rapport à la surface  
Distancia recomendada de montaje a la superficie  
Empfohlener Montageabstand von der Oberfläche  
Preporučena udaljenost montaže od površine



Diamètre du trou de montage  
Diámetro del orificio de montaje  
Durchmesser der Befestigungsbohrung  
Promjer montažnog otvora



Ballast électrique EVG  
Cebador para fluorescentes EVG  
Vorschaltgerät EVG  
EVG prigušnica



Libre de flicker  
Sin efecto de parpadeo  
Kein Flackereffekt  
Nema efekta treperenja



Prêt pour assemblage d'unité d'urgence  
Opción de montaje del módulo de emergencia CNBOP  
Möglichkeit der Montage des Nottfallsystems CNBOP  
Mogućnost montaže panik modula CNBOP



Capacité de la batterie  
Capacidad de la batería  
Batteriekapazität  
Kapacitet baterije



Type de batterie  
Tipo de batería  
Batterieart  
Tip baterije



Capteur de mouvement  
Detector de movimiento  
Bewegungssensor  
Senzor pokreta



Capteur crépusculaire  
Detector crepuscular  
Dämmerungssensor  
Senzor nivoa osvijetljenosti



Longueur du câble avec connecteur mini  
Longitud del cable con clavija mini AMP  
Kabellänge mit Mini AMP  
Dužina kabela s konektorom mini AMP



Longueur du câble avec driver  
Longitud del cable con fuente de alimentación  
Kabellänge mit Trafo  
Dužina kabela s napajanjem



Prise RJ45  
Enchufe RJ45  
RJ45 Steckdose  
Utičnica RJ45



Prise Ethernet  
Toma ethernet  
Ethernet Steckdose  
Utičnica ethernet



Prise HDMI  
Toma HDMI  
HDMI Steckdose  
Utičnica HDMI



Nombre de prises  
Número de enchufes  
Anzahl der Steckdose  
Količina utičnica



Classe de protection I  
Clase de resistencia I  
Schutzklasse I  
Razred zaštite I



Classe de protection II  
Clase de resistencia II  
Schutzklasse II  
Razred zaštite II



Classe de protection III  
Clase de resistencia III  
Schutzklasse III  
Razred zaštite III





Bornier - section de câble maximale  
Bloque de conexión - sección máxima del cable  
Anschlussblock - maximaler Kabelquerschnitt  
Redna stezaljka - maksimalna kvadratura kabla



-  Angle maximum du capteur  
Horizonte máximo de ángulo de operación del detector  
Maximale Reichweite des Arbeitswinkels des Sensors  
Maksimalni kut dometa senzora
-  Charge maximale  
Corriente máxima de carga  
Maximaler Laststrom  
Maksimalno opterećenje
-  Lieu d'assemblage  
Lugar de montaje  
Montageort  
Mjesto montaže
-  Montage surface  
Montaje en superficie  
Aufputzmontage  
Nadgradna montaža
-  Montage affleurant  
Montaje empotrado  
Unterputzmontage  
Ugradna montaža
-  Capteur 1 pôle  
Detector monofunción  
Schranktür-Schalter  
Jednosmjerni senzor
-  Capteur double pôle  
Detector bifuncional  
Bewegungsschalter  
Dvosmjerni senzor
-  Protection de sur voltage  
Protección contra sobretensiones  
Überspannungsschutz  
Prenaponska zaštita
-  Bouton TEST  
Botón de PRUEBA  
Test-Taste  
Tipka TEST

-  Fonction ZOOM  
Función ZOOM  
Zoom-Funktion  
ZOOM funkcija
-  Fonction lumière rouge alarme  
Función de luz roja de advertencia  
Rotes Licht Warnfunktion  
Funkcija upozorenja crvenog svjetla
-  Poignée magnétique  
Soporte magnético  
Magnetischer Griff  
Magnetski držač
-  Trois modes d'éclairage  
Tres modos de iluminación  
Drei-Beleuchtungs-Modi  
Tri načina svjetljenja
-  Fonction flash  
Función de flash  
Flash-Funktion  
Funkcija bljeskalice
-  Fonction Power Bank  
Función Power Bank  
Powerbank-Funktion  
Funkcija Power Bank
-  Spot à éclairage bilatéral  
Luminaria de dos lados  
Zweiseitige Beleuchtung  
Dvostrana svjetiljka
- 

-  Capteur de mouvement à micro-ondes  
Detector de movimiento por microondas  
Mikrowellen-Bewegungsmelder  
Mikrovalni senzor pokreta
-  Capteur de mouvement IR  
Detector de movimiento por IR  
IR-Bewegungssensor  
Senzor pokreta IR
-  3 types d'éclairage: (extérieur, intérieur, extérieur + intérieur)  
3 modos de iluminación: (ext., int., ext.+int.)  
3 Möglichkeiten für die Beleuchtung: (extern, intern, extern + intern)  
3 načina svjetljenja (vanjski, unutarnji, vanjsko-unutarnji)

Mode de travail "clair", le spot est alimenté en permanence - le spot éclaire aussi bien en phase d'alimentation de base que hors tension.  
Modo de funcionamiento "luz", luminaria alimentada constantemente: la luminaria se enciende tanto durante el suministro eléctrico así como tras la pérdida de suministro  
Lichtmodus, Leuchte konstant mit Strom versorgt - die Leuchte leuchtet sowohl während der Grundversorgung als auch nach deren Zerfall  
Način rada u "trajnom" spoju. Svjetiljka ima trajno napajanje - svjetiljka kako tijekom redovnog napajanja, tako i nakon prekida napajanja.

-  Capteur de mouvement en 3 étapes  
Detector de movimiento de 3 modos  
3-stufiger Bewegungsmelder  
3 stupnja rada senzora pokreta

Mode de travail "sombre", le spot est alimenté en alternance - le spot ne s'allume que lorsque l'alimentation de base s'éteint  
Modo de funcionamiento "oscuro", luminaria alimentada de forma discontinua: la luminaria solo se enciende después de la pérdida del suministro eléctrico  
Dunkler Lichtmodus, Leuchte wird nicht kontinuierlich betrieben - die Leuchte leuchtet nur bei Ausfall der Hauptstromversorgung  
Način rada u "pripravnom" spoju. Svjetiljka se ne napaja stalno - svjetiljka svijetli samo nakon prekida osnovnog napajanja.

-  3 modes d'allumage de la lampe  
3 modos de conmutación de la fuente de iluminación  
3 Lichtquellen-Schaltmodi  
3 načina rada izvornika svjetla

Mode de travail commutateur - un interrupteur extérieur détermine l'éclairage du spot en alimentation de base continue  
Modo de conmutación: la luminaria se enciende cuando la fuente de suministro eléctrico está en modo de encendido, determinado por un interruptor externo  
Schaltmodus, die Beleuchtung der Leuchte während des Betriebs wird durch einen externen Schalter bestimmt  
Način rada s prebacivanjem- o tome svijetli li svjetiljka ili ne tijekom postojanja osnovnog napajanja, određuje vanjski prekidač.

-  2 modes d'allumage de la lampe  
2 modos de conmutación de la fuente de iluminación  
2 Lichtquellen-Schaltmodi  
2 načina rada izvornika svjetla

-  Réglage de la luminosité en 3 étapes  
3 grados de regulación de la claridad  
3-stufige Helligkeitseinstellung  
3 stupnja regulacije svjetline

-  Dimmable  
Opción de oscurecimiento  
Dimmfähige Variante  
Opcija dimmera

**Ícônes eléctrica – type de base**  
**Resto de iconos electrotécnicos – tipo de casquillos**  
**Sonstige elektrotechnische Symbole – Sockettypen**  
**Ostali elektrotehnički simboli – vrste grla**

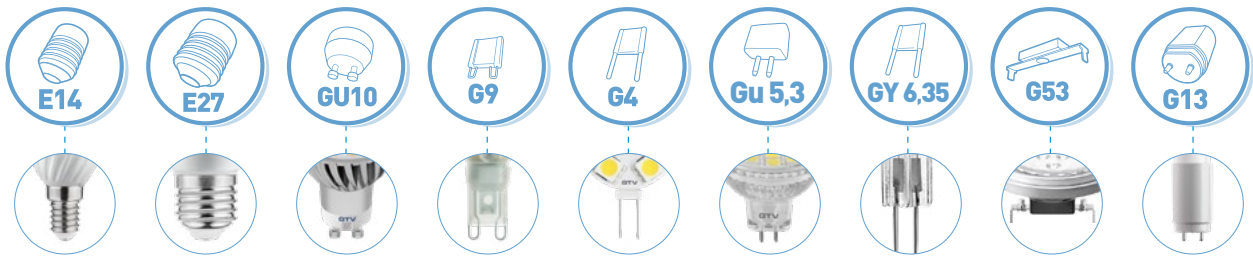

Commande DALI  
Versión DALI bajo pedido  
Auf Bestellung Version DALI  
Po narudžbi mogućnost DALI upravljanja



Sur demande un luminaire adapté au couplage avec des capteurs de mouvement  
Foco para encendido frecuente bajo pedido  
Auf Bestellung: Gerät geeignet für Einsatz mit Bewegungsmeldern  
Po narudžbi svjetiljku je moguće opremiti senzorom pokreta



Connection maximum en ligne d'unités  
Número máximo de focos para conectar en línea  
Maximale Anzahl der Leuchten, die in einer Linie angeschlossen werden können  
Maksimalan broj svjetiljki spojenih u liniju



Le pictogramme sont des les connecteurs marqués, que vous pouvez connecter a l'alimentation de 3 circuits track.  
Los conectores a los que se puede conectar la alimentación del embarrado están marcados con el pictograma.  
Die Anschlüsse, an die man Stromversorgung anschließen kann, sind mit einem Piktogramm versehen.  
Utikači označeni ovim simbolom mogu se spojiti na gradsku mrežu



Option de connexion sans outils  
Opción de conectar sin herramientas  
Möglichkeit einer Montage ohne Werkzeug  
Moguća montaža bez uporabe alata



Puissance dissipée maximale des lampes pour profils chauffés jusqu'à 65 °C, lorsqu'elle est appliquée avec des abat-jours  
La dispersión máxima de la potencia de luz para el perfil calentado hasta 65°C, como máximo, versión con campana.\*  
Maximale Verlustleistung der Leuchtmittel für ein beheiztes Profil bis maximal 65°C für die Version mit Abdeckung.\*  
Maksimalna snaga trake za koju će biti omogućeno prikladno odvođenje topline do 65o C u profilu s pokrovom.



Aucun effet de lueur  
Sin efecto deslumbramiento  
Kein Flackereffekt  
Nedostatak učinka sljepoće



Chargement sans fil  
Carga inalámbrica  
Kabelloses Laden  
Bežično punjenje



Fonction SOS, ZOOM  
Función SOS, ZOOM  
SOS, ZOOM-Funktion  
SOS, ZOOM funkcija



Module d'urgence compatible  
Coopera con módulo de emergencia  
Funktioniert mit dem Notfallmodul  
Kompatibilno s panik modulom

\* La valeur de puissance réelle, le flux lumineux et la température de couleur peuvent varier de 5% maximum aux valeurs indiquées. La température maximale de l'environnement correspondant aux résultats ci-dessus est de 240 C. La compatibilité de la bande LED et du profilé LED dépend de la méthode et du lieu d'assemblage. Los valores reales de potencia haz de luz, temperatura del color de la luz pueden variar entorno a ±5% de los valores indicados. La temperatura ambiente máxima para los resultados citados es de 24°C. La compatibilidad de la tira LED con el perfil LED depende de la forma y del lugar de montaje. Die tatsächlichen Werte für Leistung, Lichtstrom und Farbtemperatur können von den angegebenen Werten um ± 5% abweichen. Die maximale Umgebungstemperatur für die oben genannten Werte beträgt 24°C. Die Kompatibilität des LED-Streifens mit dem LED-Profil hängt von der Montageart und vom Installationsort ab. Realne vrijednosti snage, svjetlosnog toka, temperature boje mogu se razlikovati do maksimalno +5% od prikazanih vrijednosti. Maksimalna temperatura okoline za predstavljene rezultate je 24oC. Kompatibilnost LED trake i LED profila ovisi o načinu i mjestu montaže.

FR Multimètre numérique ES Multímetro digital universal DE Universell digital Messgerat HR Višenamjenski mjerač sa zaslonom



AUTO-RANGE	U.D.C. 600V U.A.C. 600V	I.D.C. 10A
R 2MΩ	DATA HOLD	
LED DIODE	1999 DISPLAY	BATTERY 1,5 / 9V

HT1E602	160 x 75 x 30 mm	1	50

FR Multimètre numérique ES Multímetro digital universal DE Universell digital Messgerat HR Višenamjenski mjerač sa zaslonom



NCV	TRUE RMS	SMART U AC/DC	AUTO-RANGE
U.D.C. 600V U.A.C. 600V	I.D.C. 10A I.A.C. 10A	R 99,99MΩ	C 10 mF
BATTERY 1,5 / 9V	DATA HOLD	LED DIODE	9999 DISPLAY

HT1E601	150 x 70 x 50 mm	1	40

FR Multimètre numérique ES Multímetro digital universal DE Universell digital Messgerat HR Višenamjenski mjerač sa zaslonom



TRUE RMS	AUTO-RANGE	SELECT	RANGE
RELATIVE	U.D.C. 600V U.A.C. 600V	I.D.C. 10A I.A.C. 10A	R 60MΩ
C 60mF	-20°C ~1000°C	0-10 MHz	DATA HOLD
MIN/MAX		5999 DISPLAY	

HT1E604	190 x 90 x 40 mm	1	20

FR Pince ampère-métrique ES Multímetro pinza universal DE Universal clamp meter HR Mjerna kliješta



NCV	TRUE RMS	AUTO-RANGE	U.D.C. 600V U.A.C. 600V	I.A.C. 600A
R 60MΩ	MAX Ø20 mm	DATA HOLD	MIN/MAX	SELECT
	RANGE		5999 DISPLAY	

HT1E621	1	20

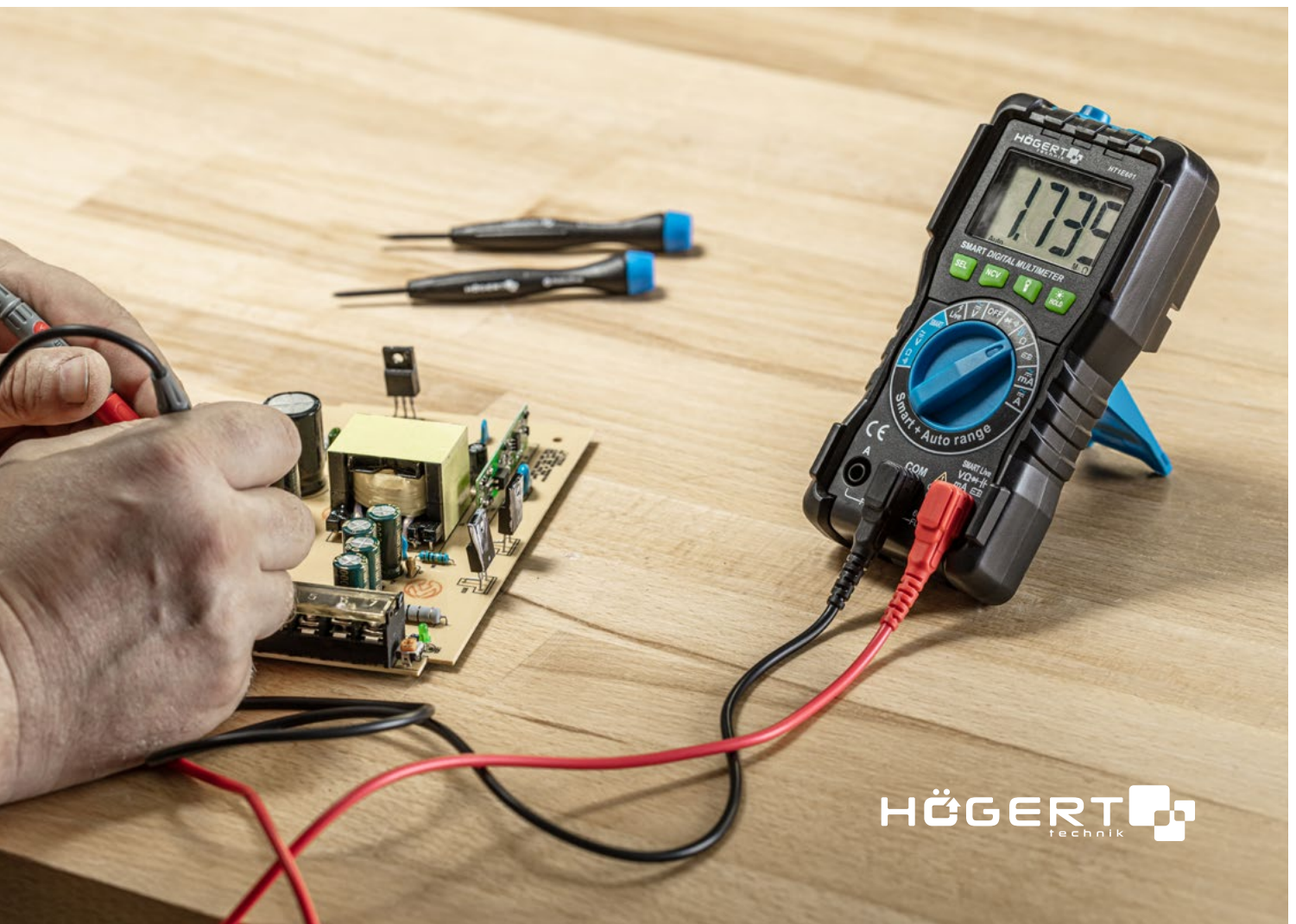





FR Pince coupe-câble ES Alicates cortacables DE Kabelzange HR Klješta za rezanje kablova

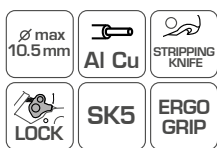

HT1P046	168 mm	∅ 10,5 mm	10	60

FR Pince coupante pour câble ES Alicates cortacables DE Kabelzange HR Klješta za rezanje kablova



HT1P042	160 mm	∅ 3 mm	6	60
HT1P044	200 mm	∅ 11 mm	6	60

FR Coupe-câble ES Cortador de cables DE Kabelschneider HR Škare za kablove

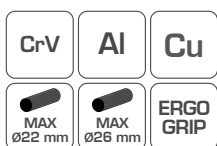

HT1P048	450 mm	1	12
HT1P049	600 mm	1	12

FR Pince coupante de câble ES Alicates cortacables DE Kraft-Seitenschneider HR Klješta za rezanje žica i kablova



HT1P045	185 mm	1,3 - 8,0 mm <sup>2</sup> (16, 14, 12, 10, 8 AWG)	10	120



FR Pince à dénuder automatique ES Alicates Pelacables automático DE Automatische Abisolierzange HR Automatska kliješta za skidanje izolacije



0,05-10 mm <sup>2</sup>	30-8 AWG	CUTTER SK5
STRIPPER SK5	HIGH PRECISION	ERGO GRIP

HT1P182	210 mm	0,05 to 10,0 mm <sup>2</sup> (30-8 AWG)	10	60

FR Pince à dénuder ES Pelacables DE Kable Abisolierer HR Alat za skidanje izolacije



0,5-5,0 mm <sup>2</sup>	20-10 AWG	8-13 mm <sup>2</sup>
RG 6	RG 59	SK5

HT1P102	122 mm	0,5-6,0 mm <sup>2</sup> (20-10 AWG)	15	90

FR Pince automatique à dénuder ES Alicates Pelacables automático DE Automatische Abisolierzange HR Automatski alat za skidanje izolacije



1,0-3,2 mm <sup>2</sup>	18-12 AWG	SK5	ERGO GRIP
-------------------------	-----------	-----	-----------

HT1P188	168 mm	1,0-3,2 mm <sup>2</sup> (18-12 AWG)	8	48

FR Pince à dénuder ES Pelacables DE Kable Abisolierer HR Alat za skidanje izolacije









4P 6P 8P	RG 6	RG 59
TRISSET 113 Profi 11	SK5	

HT1P103	125 mm	RG-6, RG-59, Triset-113, Triset Profi, Triset-11	10	50





FR Pince à sertir interchangeable **ES** Tenaza crimpadora con mordazas intercambiables **DE** Crimpzange, Set mit 6 wechselbaren Einsätzen **HR** Kliješta za stezanje sa izmenljivim čeljustima



- A  0.5 - 6 mm<sup>2</sup> (22 - 10 AWG)
- A1  0.5 - 10 mm<sup>2</sup> (22 - 8 AWG)
- A2  0.5 - 6 mm<sup>2</sup> (22 - 10 AWG)
- A3  0.1 - 1.5 mm<sup>2</sup> (26 - 16 AWG)
- A4  0.5 - 2.5 mm<sup>2</sup> (22 - 14 AWG)
- A5  0.5 - 6 mm<sup>2</sup> (22 - 10 AWG)



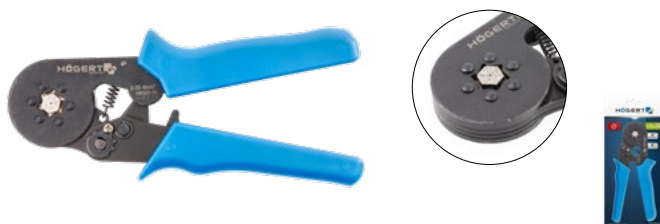

×7
QUICK EXCHANGE
RATCHET
ERGO GRIP

			
HT1P176	220 mm	1	10

FR Pince à sertir auto-réglable **ES** Tenaza crimpadora autoajustable **DE** Crimpzange, selbsteinstellend **HR** Samopodesiva kliješta za stezanje tankoslojnih čahura



0.25-6.0 mm<sup>2</sup>
23-10 AWG

				
HT1P205	175 mm	0.25-6 mm <sup>2</sup> (23-10 AWG)	10	50





FR Pack de tournevis isolés 1000 V ES Pack de destornilladores aislados 1000 V DE Schraubendreher-Satz 1000 V HR Set odvijača, izolirani 1000 V



$\ominus$  1,2 x 6,5 x 100 mm,  
 1,0 x 5,5 x 100 mm,  
 0,8 x 4,0 x 100 mm,  
 0,5 x 3,0 x 100 mm  
 $\oplus$  PH2 x 100 mm,  
 PH1 x 80 mm,  
 PZ2 x 100 mm,  
 PZ1 x 80 mm  
 $\bullet$  T10 x 100 mm,  
 T15 x 100 mm,  
 T20 x 100 mm  
 Voltage tester 140 mm



x13 VDE 1000V S2 MAGNETIC ERGO GRIP

HT1S997	1	72

FR Pince combinée isolée 1000 V ES Alicates universales 1000 V DE Kombinationsszange 1000 V HR Univerzalna kličesta 1000 V



VDE 1000V CrV HRC 55-60 DIN 5749

HT1P903	160 mm	6	60
HT1P905	180 mm	6	60
HT1P907	200 mm	6	60

FR Tournevis à sertir 1000 V ES Destornillador para cuadros de la luz 1000 V, SLIM DE Schraubendreher für Plus-Minus Klemmschrauben HR Odvijači 1000 V SLIM



VDE 1000V SLIM PH  
 PZ SL CrMo  
 MAGNETIC ERGO GRIP EN 60900

		L1	L2		
HT1S973	PH1/SL5	100 mm	192 mm	12	240
HT1S974	PH2/SL6	100 mm	210 mm	12	120
HT1S976	PZ1/SL5	100 mm	192 mm	12	240
HT1S977	PZ2/SL6	100 mm	210 mm	12	120

FR Coupe-bordures diagonales isolées 1000 V ES Alicates de corte 1000 V DE Seitenschneider 1000 V HR Bočna kličesta 1000 V



VDE 1000V CrV HRC 55-60 DIN 5749 HIGH LEVERAGE

HT1P909	160 mm	6	60
HT1P911	180 mm	6	60

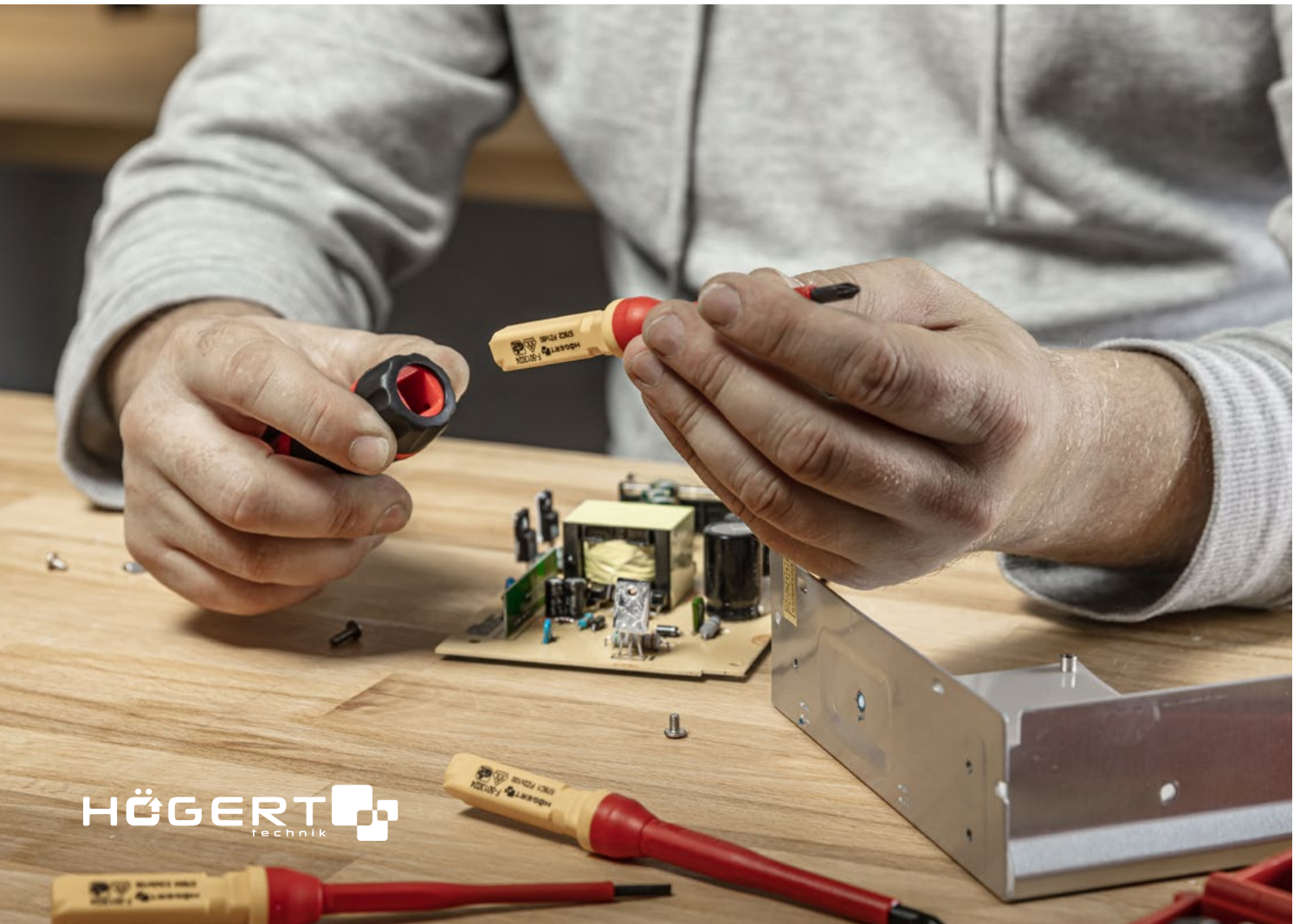





**A**

AE-27GU10-00.....	388
AE-BPW1FACP-10.....	478
AE-BPW1FACP-20.....	478
AE-BPW1S1UCH-51.....	489
AE-BPW1S1UCH-53.....	488
AE-BPW1S2UCH-80.....	488
AE-BPW1SACP-10.....	478
AE-BPW1SACP-20.....	478
AE-BPW1U1UCH-51.....	489
AE-BPW1U1UCH-53.....	488
AE-BPW1U2UCH-80.....	488
AE-BPW2FCAM-10.....	482
AE-BPW2FCAM-20.....	482
AE-BPW2SCAM-10.....	482
AE-BPW2SCAM-20.....	482
AE-BPW3GS-20.....	490
AE-BPW3GS-80.....	490
AE-BPW3GU-20.....	490
AE-BPW3GU-80.....	490
AE-BPW3S60-20.....	490
AE-BPW3S60-80.....	490
AE-BPW3S60U-20.....	490
AE-BPW3S60U-80.....	490
AE-BPW3S100U-53.....	489
AE-BPW3U60-20.....	490
AE-BPW3U60-80.....	490
AE-BPW3U60U-20.....	490
AE-BPW3U60U-80.....	490
AE-BPW3U100U-53.....	489
AE-BPW4F120P-10.....	480
AE-BPW4F120P-20.....	480
AE-BPW4S100-53.....	489
AE-BPW4S120P-10.....	480
AE-BPW4S120P-20.....	480
AE-BPW4U100-53.....	489
AE-CANOPY-10.....	393
AE-CM3M00-00.....	372
AE-CM3M00-10.....	372
AE-CM1000-00.....	371
AE-CM1500-00.....	375
AE-CM3000-00.....	372
AE-CM4000-00.....	373
AE-CM5000-00.....	373
AE-CM6000-00.....	374
AE-CM9000-00.....	375
AE-CM9000-10.....	375
AE-E14E27-00.....	388
AE-E14GU10-00.....	387
AE-E14RING-10.....	389
AE-E27E14-00.....	388
AE-E27RING-10.....	389
AE-E40E27-00.....	389
AE-GIR10-10.....	287
AE-GR610-10.....	286
AE-GU10E27-00.....	389
AE-MA8028-00.....	392
AE-MA8028-10.....	392
AE-MAS80X80-00.....	392
AE-MAS80X80-10.....	392
AE-OCEE14-00.....	385
AE-OCEE27-00.....	386
AE-OCEE27-MM.....	386
AE-OCEE40-00.....	386
AE-OCEF27-00.....	385

AE-OPE27P-00.....	387
AE-PB1FAVA-10.....	486
AE-PB1FAVA-20.....	486
AE-PB1FAVA-53.....	486
AE-PB1FAVAP-10.....	484
AE-PB1FAVAP-20.....	484
AE-PB1FAVAP-53.....	484
AE-PB1SAVA-10.....	486
AE-PB1SAVA-20.....	486
AE-PB1SAVA-53.....	486
AE-PB1SAVAP-10.....	484
AE-PB1SAVAP-20.....	484
AE-PB1SAVAP-53.....	484
AE-PB2FPRES-10.....	476
AE-PB2FPRES-20.....	476
AE-PB2FPRES-53.....	476
AE-PB2SPRES-10.....	476
AE-PB2SPRES-20.....	476
AE-PB2SPRES-53.....	476
AE-PB03GS-10.....	491
AE-PB03GS-20.....	491
AE-PB03GS-53.....	491
AE-PB03GU-53.....	491
AE-PBC3GS2U-53BKS.....	494
AE-PBC3GS-51BK.....	494
AE-PBC3GS-53BKS.....	494
AE-PBC3GU-10.....	491
AE-PBC3GU-20.....	491
AE-PBC3GU-51BK.....	494
AE-PBC3GU-53.....	491
AE-PBKT3S2U-80.....	495
AE-PBKT3U2U-80.....	495
AE-PBKT4S-80.....	495
AE-PBKT4U-80.....	495
AE-PBSC3GS-10.....	492
AE-PBSC3GS-20N.....	492
AE-PBSC3GS-53.....	492
AE-PBSC3GU-10.....	492
AE-PBSC3GU-20N.....	492
AE-PBSC3GU-53.....	492
AE-PBSUC2GS-10.....	492
AE-PBSUC2GS-20N.....	492
AE-PBSUC2GS-53.....	492
AE-PBSUC2GU-10.....	492
AE-PBSUC2GU-20N.....	492
AE-PBSUC2GU-53.....	492
AE-PBU02GS-10.....	491
AE-PBU02GS-20.....	491
AE-PBU2GU-10.....	491
AE-PBU2GU-20.....	491
AE-PBU2GU-53.....	491
AE-PF3G1M-00.....	380
AE-PF3G3M-00.....	380
AE-PF3G5M-00.....	380
AE-PF5G3M-00.....	380
AE-PF5G5M-00.....	380
AE-PFBEBEN-20.....	381
AE-PFBEBEN-40.....	381
AE-POGRODUN-10.....	382
AE-POGRODUN-20.....	382
AE-POGRODUN-30.....	382
AE-PS3G3M-00.....	380
AE-PS3G5M-00.....	380
AE-PS4G3M-00.....	380
AE-PS4G5M-00.....	380
AE-PS5G3M-00.....	380

AE-PS5G5M-00.....	380
AE-RU0102-00.....	383
AE-RU0103-00.....	385
AE-RU0121-00.....	383
AE-SBEBEN-30.....	381
AE-SBEBEN-50.....	381
AE-SC0102-00.....	384
AE-SC0103-00.....	384
AE-SRC812-00.....	377
AE-SRC812-MIN.....	376
AE-SRC812-MIN2.....	376
AE-VA1UNI-00.....	384
AE-VA1UNI-10.....	384
AE-WBBUNI-10DIM.....	462
AE-WBCUNI-10DIM.....	462
AE-WBE1-10.....	462
AE-WBE1-20.....	462
AE-WBE2-10.....	463
AE-WBE2-20.....	463
AE-WBEZDB-10S*.....	460
AE-WBEZDC-10S.....	460
AE-WBEZDK15-10.....	460
AE-WBEZD-NBN.....	464
AE-WBEZDPIR2-20.....	461
AE-WBEZDPIR-10.....	461
AE-WDBP1-10 N.....	458
AE-WDBP1-20 N.....	458
AE-WDBP2CCT-10N.....	458
AE-WDBP2CCT-20N.....	458
AE-WDSB-10DIM.....	463
AE-WDSC-10DIM.....	463
AE-WLB01-10.....	465
AE-WLC01-20.....	465
AE-WLIP44-15.....	466
AE-WLLAN1-10.....	467
AE-WLLAN1-20.....	467
AE-WLLAN1-90.....	467
AE-WLPR-60.....	465
AE-WLPR-60P2.....	465
AE-WLSZN1-10.....	467
AE-WPDRW-00.....	464
AE-ZLADLUX-40.....	473
AE-ZLADPOD-20.....	473
AE-ZUSB-20.....	474

**B**

BK-BHL050-1000BZ.....	396
BK-BHL060-1300BZ.....	396
BK-PULO30A-0700AD.....	396
BK-PULO42A-0700BD.....	396
BK-PULO42A-1100AD.....	396
BK-PULO60A-2000AD.....	396

**C**

CR-CO1000-00.....	366
CR-CO2000-00.....	366
CR-CR3M00-00.....	361
CR-CR3M00-10.....	361
CR-CR4L00-00.....	362
CR-CR5M00-00.....	363
CR-CR9M00-00.....	365
CR-CR9M00-10.....	365
CR-CR1000-00.....	360
CR-CR1000-10.....	360
CR-CR1100-00.....	367

CR-CR1200-00.....	367
CR-CR1400-00.....	368
CR-CR2000-00.....	360
CR-CR2000-10.....	360
CR-CR3000-00.....	361
CR-CR3000-10.....	361
CR-CR5000-00.....	362
CR-CR6000-00.....	363
CR-CR7000-00.....	364
CR-CR8000-00.....	364
CR-CR9000-00.....	365
CR-CR9000-10.....	365
CR-CR13000-00.....	368
CR-CR15000-00.....	369
CR-CR16000-00.....	369
CR-CR17000-00.....	370
CR-CR18000-00.....	370
CR-CR19000-00.....	371
CZ-CZ1000-00.....	377
CZ-CZ2000-00.....	378

**G**

GT-RM30X60-00.....	75
GT-RM30X120-00.....	75
GT-RM60X60-00.....	75
GZ-E27000-00.....	387
GZ-E27000-10.....	387
GZ-G90000-00.....	383
GZ-GZ10-0000.....	382
GZ-MR16-0000*.....	382

**K**

KB-W310HUG-20.....	394
KB-W313HUG-20.....	394

**L**

LB-ARCH8W-00.....	307
LB-ARCH8W-10.....	307
LB-BRE8W-11-DEC.....	304
LB-BRE8W-15-DEC.....	304
LB-FLOW4W-06-DEC.....	298
LB-FRO5W-00-DEC.....	296
LB-GAL3WRU-10.....	295
LB-GAL5WMO-10.....	300
LB-GAL5WRU-10.....	295
LB-GAL8W-00-DEC.....	302
LB-GAL8W-10-DEC.....	302
LB-HAL8W-00-DEC.....	296
LB-HAL8W-10-DEC.....	296
LB-HEL6W-00-DEC.....	304
LB-HEL6W-15-DEC.....	304
LB-HEL6W-20-DEC.....	304
LB-HEL6W-25-DEC.....	304
LB-HIK6WCCT-00.....	298
LB-HIK6WCCT-10.....	298
LB-IZK6WCCT-00.....	299
LB-IZK6WCCT-10.....	299
LB-LIN7W-00-DEC.....	300
LB-LIN7W-10-DEC.....	300
LB-LON12W-10-DEC.....	306
LB-MON3W-02-DEC.....	306
LB-MON3W-40-DEC.....	306
LB-MON3W-41-DEC.....	306
LB-TRIT6W-00-DEC.....	303
LB-TRIT6W-10-DEC.....	303

LB-VEN20W-10.....	307	LD-5630-300-20-ZB.....	405	LD-BOS1CBWG-53.....	445	LD-IND60W-40.....	140
LB-VEN20WO-00.....	307	LD-5630-300-65-CB.....	405	LD-CANTI12WKW-40.....	274	LD-IND100W-40.....	140
LD-3SKL-ZBN.....	445	LD-5630-300-65-NE4.....	405	LD-CANTI12WOK-40.....	274	LD-IND150W-40.....	140
LD-2835-24V-300-20-CB.....	407	LD-5630-300-65-ZB.....	405	LD-COB12V-20-CBN.....	408	LD-INEXT10W-64.....	128
LD-2835-24V-300-20-NE4.....	407	LD-AKO4060-NB.....	66	LD-COB12V-20-CBPQ.....	408	LD-INEXT20W-64.....	128
LD-2835-24V-300-20-ZB.....	407	LD-AL24CB-53.....	440	LD-COB12V-20-NEN.....	408	LD-INEXT30W-64.....	128
LD-2835-24V-600-20-CB.....	407	LD-AL24NE-53.....	440	LD-COB12V-20-NEPQ.....	408	LD-INEXT30WP-64.....	128
LD-2835-24V-600-20-NE4.....	407	LD-AL24ZB-53.....	440	LD-COB12V-20-ZBN.....	408	LD-INEXT50W-64.....	128
LD-2835-24V-600-20-ZB.....	407	LD-ALCX10W-64.....	131	LD-COB12V-20-ZBPQ.....	408	LD-INEXT50WP-64.....	128
LD-2835-60-60-20-CCT.....	405	LD-ALCX20W-64*.....	131	LD-COB24V-20-CBN.....	408	LD-IRUSB-53.....	444
LD-2835-300-20-CB.....	404	LD-ARC15W-NB.....	125	LD-COB24V-20-NEN.....	408	LD-JAS15W-40.....	174
LD-2835-300-20-CB-50.....	406	LD-ARC25W-NB.....	125	LD-COB24V-20-ZBN.....	408	LD-KABE2M-00.....	394
LD-2835-300-20-CBN.....	404	LD-ARC30W-NB.....	125	LD-CORSO1-00.....	144	LD-KABE2M-00.....	468
LD-2835-300-20-NE4N.....	404	LD-ARG30W60-NB.....	72	LD-CORSO3-00.....	144	LD-KABE2M-10.....	394
LD-2835-300-20-NE4P.....	404	LD-ARG40W60-NB.....	72	LD-CS36CB-53.....	440	LD-KALU100K-40.....	99
LD-2835-300-20-NE4P-50.....	406	LD-ARG55W60-NB*.....	72	LD-CS36NE-53.....	440	LD-KALU100W-40.....	99
LD-2835-300-20-ZB.....	404	LD-ARZ18W-CCT.....	122	LD-CS36ZB-53.....	440	LD-KAN150W-NB.....	136
LD-2835-300-20-ZB-50.....	406	LD-ARZ25W-CCT.....	122	LD-DA200W-40.....	127	LD-KAN200W-NB.....	136
LD-2835-300-20-ZBN.....	404	LD-ARZ35W-CCT.....	122	LD-DAL100W-NB.....	136	LD-KAR18W-CCT.....	124
LD-2835-300-65-CB.....	404	LD-ASTID13-NW-00.....	95	LD-DAL150W-NB.....	136	LD-KAR25W-CCT.....	124
LD-2835-300-65-CBN.....	404	LD-ASTR12WM-NW-00.....	96	LD-DE40062-NB.....	73	LD-KAT400-00.....	247
LD-2835-300-65-NE4.....	404	LD-ASTR12W-NW-00.....	95	LD-DE40062UGR-NB.....	73	LD-KAT400-01.....	247
LD-2835-300-65-NE4N.....	404	LD-ASTR18WM-NW-00.....	96	LD-DELOR6WC-NB.....	102	LD-KAT400-10.....	247
LD-2835-300-65-ZB.....	404	LD-ASTR18W-NW-00.....	95	LD-DELOW6WC-NB.....	102	LD-KAT600-00.....	247
LD-2835-300-65-ZBN.....	404	LD-ASTR24WM-NW-00.....	96	LD-DIMLED-10.....	466	LD-KAT600-01.....	247
LD-2835-600-5MM-20-CB.....	405	LD-ASTR24W-NW-00.....	95	LD-DNV15W-NB.....	122	LD-KAT600-10.....	247
LD-2835-600-5MM-20-NE4.....	405	LD-ATM15WBP-NB.....	184	LD-DNV20W-NB.....	122	LD-KD08WOK-NB.....	103
LD-2835-600-5MM-20-ZB.....	405	LD-ATM15WCP-NB.....	184	LD-DNV30W-NB.....	122	LD-KD08WV-NB.....	103
LD-2835-600-20-CB.....	404	LD-ATM20WBK-NB.....	184	LD-ESKA084-51.....	246	LD-KD12WOK-NB.....	103
LD-2835-600-20-NE4.....	404	LD-ATM20WCK-NB.....	184	LD-ESKB084-51.....	246	LD-KD12WV-NB.....	103
LD-2835-600-20-ZB.....	404	LD-ATOL32W-NW-02.....	91	LD-ESOA084-51.....	244	LD-KLPCB-00N.....	445
LD-2835-600-65-CB.....	404	LD-ATOL32W-NW-10.....	91	LD-ESOB084-51.....	244	LD-KLPNB-00N.....	445
LD-2835-600-65-NE4.....	404	LD-ATOL32W-NW-40.....	91	LD-FEN20W-NW-00.....	90	LD-KLPZB-00N.....	445
LD-2835-600-65-ZB.....	404	LD-ATOL32W-WW-02.....	91	LD-FEN30W-NW-00.....	90	LD-KNG45060-NB.....	72
LD-3014-1200-20-CB.....	405	LD-ATOL32W-WW-10.....	91	LD-FRT36WB-NB.....	174	LD-KNG45312-NB.....	72
LD-3014-1200-20-NE4.....	405	LD-ATOL32W-WW-40.....	91	LD-GL40060-NB.....	69	LD-KONMINI-RGB.....	453
LD-3014-1200-20-ZB.....	405	LD-BA2E27-00.....	285	LD-GL40060UGR-NB.....	70	LD-KONML-AD.....	456
LD-3528-300-20-CB.....	404	LD-BA2GU10-OM.....	285	LD-GL40120-NB.....	69	LD-KONML-MONO.....	454
LD-3528-300-20-CB-50.....	406	LD-BALE27-00.....	285	LD-HAG136-30.....	152	LD-KONML-MONO-PAN.....	454
LD-3528-300-20-NE4P.....	404	LD-BALGU10-0S.....	285	LD-HAG158-30.....	152	LD-KONML-MONO-PIL.....	454
LD-3528-300-20-NE4P-50.....	406	LD-BERGA50W-30.....	77	LD-HAG218-30.....	152	LD-KONML-RGBW.....	455
LD-3528-300-20-NI.....	404	LD-BERGA70W-30.....	77	LD-HAG236-30.....	152	LD-KONML-RGBW-PIL.....	455
LD-3528-300-20-ZB.....	404	LD-BES24WKW-30.....	87	LD-HAG236KL-ME.....	153	LD-KONML-WIFI.....	456
LD-3528-300-20-ZB-50.....	406	LD-BES24WKW-40.....	87	LD-HAG236KL-ME.....	153	LD-KONML-WRGB-PAN.....	455
LD-3528-300-65-CB.....	404	LD-BES24WOK-30.....	87	LD-HAG258-30.....	152	LD-KWP27CB-53.....	443
LD-3528-300-65-NE4.....	404	LD-BES24WOK-40.....	87	LD-HB150W-40.....	134	LD-LIV40WNB-00.....	173
LD-3528-300-65-ZB.....	404	LD-BESTA40W-30.....	78	LD-HEL136B-30.....	152	LD-LIV40WNB-10.....	173
LD-3528-600-20-CB.....	404	LD-BESTA60W-30.....	78	LD-HEL218B-30.....	152	LD-LNG24WB-NB.....	83
LD-3528-600-20-CB-50.....	406	LD-BETISD50W-30.....	77	LD-HEL236B-30.....	152	LD-LNG48WB-NB.....	83
LD-3528-600-20-NE4.....	404	LD-BETISD70W-30.....	77	LD-HEL236BU-ME.....	153	LD-LOG16W-LED.....	96
LD-3528-600-20-NE4-50.....	406	LD-BLRKW18W-61.....	116	LD-HEL236BU-ME.....	153	LD-LSNK06W-NB.....	112
LD-3528-600-20-ZB.....	404	LD-BLROK18W-61.....	116	LD-HEL258B-30.....	152	LD-LSNK12W-NB.....	112
LD-3528-600-20-ZB-50.....	406	LD-BNC8WKB-NB.....	176	LD-HEL258BU-ME.....	153	LD-LSNK24W-NB.....	112
LD-3528-600-65-CB.....	404	LD-BNC8WKC-NB.....	176	LD-HEL258BU-ME.....	153	LD-LSNO06W-NB.....	112
LD-3528-600-65-NE4.....	404	LD-BNC8WOB-NB.....	176	LD-HER60W12-NB.....	82	LD-LSNO12W-NB.....	112
LD-3528-600-65-ZB.....	404	LD-BNC8WOC-NB.....	176	LD-HR2X18W12-30.....	80	LD-LSNO24W-NB.....	112
LD-5050-300-20-CB.....	405	LD-BNC15WKB-NB.....	180	LD-ILUXC10W-64.....	130	LD-LSWK03W-NB.....	114
LD-5050-300-20-NE4.....	405	LD-BNC15WKC-NB.....	180	LD-ILUXC20W-64.....	130	LD-LSWK06W-NB.....	114
LD-5050-300-20-NE4-50.....	406	LD-BNC15WOB-NB.....	180	LD-ILUXC30W-64I.....	130	LD-LSWK15W-NB.....	114
LD-5050-300-20-ZB.....	405	LD-BNC15WOC-NB.....	180	LD-ILUXC50W-64.....	130	LD-LSWK24W-NB.....	114
LD-5050-300-65-CB.....	405	LD-BNCC8WKB-NB.....	178	LD-ILUXC100W-64.....	130	LD-LSWO03W-NB.....	114
LD-5050-300-65-NE4.....	405	LD-BNCC8WKC-NB.....	178	LD-ILUXCC10W-64.....	130	LD-LSWO06W-NB.....	114
LD-5050-300-65-ZB.....	405	LD-BNCC8WOB-NB.....	178	LD-ILUXCC20W-64.....	130	LD-LSWO15W-NB.....	114
LD-5630-300-20-CB.....	405	LD-BNCC8WOC-NB.....	178	LD-ILUXCC30W-64.....	130	LD-LSWO24W-NB.....	114
LD-5630-300-20-NE4.....	405	LD-BNCC16WOB2-NB.....	179	LD-ILUXCC50W-64.....	130	LD-LU16CB-53.....	439
LD-5630-300-20-NE4-50.....	406	LD-BNCC16WOC2-NB.....	179	LD-ILUXCC100W-64.....	130	LD-LU16NE-53.....	439

LD-LU16ZB-53.....	439	LD-MZ18WKW-NB.....	111	LD-ORW19W-CBP4.....	107	LD-STARS24W-NW-00.....	88
LD-LUM120-30P.....	82	LD-MZ18WOK-NB.....	111	LD-ORW19W-CBP-10.....	108	LD-STARS48W-NW-00.....	88
LD-LUM150-30P.....	82	LD-NESSAGU10D-20.....	278	LD-ORW19W-NBP.....	107	LD-STELO80W-40.....	140
LD-LUN40WNB-00-A.....	172	LD-NESSAGU10D-80.....	278	LD-ORW19W-NBP4.....	107	LD-STEL150W-40.....	140
LD-LUN40WNB-10-A.....	172	LD-NESSAGU10J-20.....	278	LD-ORW19W-NBP-10.....	108	LD-TERNO1-00.....	143
LD-LUNAR60-40.....	78	LD-NESSAGU10J-80.....	278	LD-ORW24W-CBP.....	107	LD-TERNO3-00.....	143
LD-LUNAR120-80.....	78	LD-NF-12V6x12-65-CB.....	409	LD-ORW24W-CBP4.....	107	LD-TIAGOGU10D-01.....	284
LD-MA24063-NB.....	70	LD-NF-12V6x12-65-NE.....	409	LD-ORW24W-CBP-10.....	108	LD-TIAGOGU10D-01KW.....	282
LD-MA40060-NB.....	70	LD-NF-12V6x12-65-ZB.....	409	LD-ORW24W-NBP.....	107	LD-TIAGOGU10D-20.....	284
LD-MA40312-NB.....	70	LD-OBP27CB-53.....	443	LD-ORW24W-NBP4.....	107	LD-TIAGOGU10D-20KW.....	282
LD-MAN07W-CBP.....	108	LD-OBP27ZB-53.....	443	LD-ORW24W-NBP-10.....	108	LD-TIAGOGU10J-01.....	284
LD-MAN07W-CBP-10.....	110	LD-OGLA3W-00.....	145	LD-OSA16WD-40.....	93	LD-TIAGOGU10J-01KW.....	282
LD-MAN07W-NBP.....	108	LD-OGLA3W-10.....	145	LD-OSA22WD-40.....	93	LD-TIAGOGU10J-20.....	284
LD-MAN07W-NBP-10.....	110	LD-OLL20W-CB.....	84	LD-OXCX10W-64.....	131	LD-TIAGOGU10J-20KW.....	282
LD-MAN13W-CBP.....	108	LD-OLL20W-NB.....	84	LD-OXCX20W-64.....	131	LD-TK100W-40.....	133
LD-MAN13W-CBP-10.....	110	LD-OLL40W-CB.....	84	LD-OZE218-00.....	151	LD-TOK16WD-40.....	93
LD-MAN13W-NBP.....	108	LD-OLL40W-NB.....	84	LD-OZE218-01.....	151	LD-TOK16WP-40.....	92
LD-MAN13W-NBP-10.....	110	LD-OLL50W-CB.....	84	LD-OZE236-00.....	151	LD-TOK22W-40.....	92
LD-MAN19W-CBP.....	108	LD-OLL50W-NB.....	84	LD-OZE236-01.....	151	LD-TOK22WD-40.....	93
LD-MAN19W-CBP-10.....	110	LD-OMAH33-00.....	145	LD-PAR10W40-00.....	276	LD-TR24CB-53.....	442
LD-MAN19W-NBP.....	108	LD-OME30WNB-10-L.....	170	LD-PAR10W40-10.....	276	LD-TR24NE-53.....	442
LD-MAN19W-NBP-10.....	110	LD-OME30WNB-10-T.....	170	LD-PAR10W40BC-00.....	276	LD-TR24ZB-53.....	442
LD-MAN24W-CBP.....	108	LD-OME50WNB-10-A*.....	170	LD-PAR10W40BC-10.....	276	LD-TWI10WOK-40.....	100
LD-MAN24W-CBP-10.....	110	LD-OME50WNB-10-C.....	170	LD-PARK3L30W-40.....	139	LD-TWI10WOW-40.....	100
LD-MAN24W-NBP.....	108	LD-OMN060-30B.....	81	LD-PARK3L50W-40.....	139	LD-TWN09W-CB.....	118
LD-MAN24W-NBP-10.....	110	LD-OMN120-60B.....	81	LD-PARK3L80W-40.....	139	LD-TWN16W-CB.....	118
LD-MAW03W-CBP.....	109	LD-OMN120B-75M.....	81	LD-PIRUSB-53.....	444	LD-TWW09W-CB.....	118
LD-MAW03W-CBP4.....	109	LD-OMN150-70B.....	81	LD-PRM10WB-NB.....	175	LD-TWW16W-CB.....	118
LD-MAW03W-NBP.....	109	LD-OMN150B-90M.....	81	LD-PRM10WC-NB.....	175	LD-UNF-12V6X12-6X.....	409
LD-MAW03W-NBP4.....	109	LD-ONT120-36.....	84	LD-PRM10WS-NB.....	175	LD-VA24CB-53.....	439
LD-MAW07W-CBP.....	109	LD-ONTEND-00.....	85	LD-RA60CB-40N.....	444	LD-VA24NE-53.....	439
LD-MAW07W-CBP4.....	109	LD-ONTMCI-00.....	85	LD-RA60ZB-40N.....	444	LD-VALLA8W-40.....	272
LD-MAW07W-CBP-10.....	110	LD-ONTPWR-00.....	85	LD-RGB-150-20.....	405	LD-VALLA12W-40.....	272
LD-MAW07W-NBP.....	109	LD-ORN07W-CBP.....	106	LD-RGB-150-65.....	405	LD-VE15CB-53N.....	441
LD-MAW07W-NBP4.....	109	LD-ORN07W-CBP-10.....	106	LD-RGBW-300-20.....	405	LD-VE15CBZB-53N.....	441
LD-MAW07W-NBP-10.....	110	LD-ORN07W-NBP.....	106	LD-SAHER1-DUO.....	143	LD-VE15NE-53N.....	441
LD-MAW13W-CBP.....	109	LD-ORN07W-NBP-10.....	106	LD-SAHER3-DUO.....	143	LD-VE15ZB-53N.....	441
LD-MAW13W-CBP4.....	109	LD-ORN13W-CBP.....	106	LD-SATU12WM-NB.....	91	LD-VIL42WUDB-NB.....	173
LD-MAW13W-CBP-10.....	110	LD-ORN13W-CBP-10.....	106	LD-SATU12W-NW-00.....	90	LD-VIL42WUDC-NB.....	173
LD-MAW13W-NBP.....	109	LD-ORN13W-NBP.....	106	LD-SATU18WM-NB.....	91	LD-VIPERS30W-40.....	127
LD-MAW13W-NBP4.....	109	LD-ORN13W-NBP-10.....	106	LD-SATU18W-NW-00.....	90	LD-VIPERS50W-40.....	127
LD-MAW13W-NBP-10.....	110	LD-ORN19W-CBP.....	106	LD-SATU24WM-NB.....	91	LD-VIPERS100W-40.....	127
LD-MAW19W-CBP.....	109	LD-ORN19W-CBP-10.....	106	LD-SATU24W-NW-00.....	90	LD-VIPERS150W-40.....	127
LD-MAW19W-CBP4.....	109	LD-ORN19W-NBP.....	106	LD-SATU32W-NW-00.....	90	LD-VLRKW0538-CB.....	120
LD-MAW19W-CBP-10.....	110	LD-ORN19W-NBP-10.....	106	LD-SATU48W-NW-00.....	90	LD-VLRKW0538-NB.....	120
LD-MAW19W-NBP.....	109	LD-ORN24W-CBP.....	106	LD-SILVAGU10D-20.....	280	LD-VLRKW0738-CCT.....	121
LD-MAW19W-NBP4.....	109	LD-ORN24W-CBP-10.....	106	LD-SILVAGU10D-80.....	280	LD-VLRKW1038-CB.....	120
LD-MAW19W-NBP-10.....	110	LD-ORN24W-NBP.....	106	LD-SILVAGU10J-20.....	280	LD-VLRKW1038-NB.....	120
LD-MAW24W-CBP.....	109	LD-ORN24W-NBP-10.....	106	LD-SILVAGU10J-80.....	280	LD-VLRK0538-CB.....	120
LD-MAW24W-CBP4.....	109	LD-ORW03W-CBP.....	107	LD-SMBKW07W-21.....	115	LD-VLRK0538-NB.....	120
LD-MAW24W-CBP-10.....	110	LD-ORW03W-CBP4.....	107	LD-SMBKW14W-21.....	115	LD-VLRK0738-CCT.....	121
LD-MAW24W-NBP.....	109	LD-ORW03W-NBP.....	107	LD-SMBKW24W-21.....	115	LD-VLRK1038-CB.....	120
LD-MAW24W-NBP4.....	109	LD-ORW03W-NBP4.....	107	LD-SMBOK07W-21.....	115	LD-VLRK1038-NB.....	120
LD-MAW24W-NBP-10.....	110	LD-ORW07W-CBP.....	107	LD-SMBOK14W-21.....	115	LD-WZA20W-NW.....	451
LD-MCR12W-NB.....	97	LD-ORW07W-CBP4.....	107	LD-SMBOK20W-21.....	115	LD-WZA36W-NW.....	451
LD-MISS7WKC-NB.....	273	LD-ORW07W-CBP-10.....	108	LD-SOL36W40-NB.....	66	LD-WZA60W-NW.....	451
LD-MISS7WKS-NB.....	273	LD-ORW07W-NBP.....	107	LD-SRA08WB-NB.....	182	LD-WZA80W-NW.....	451
LD-MISS7WOC-NB.....	273	LD-ORW07W-NBP4I.....	107	LD-SRA08WC-NB.....	182	LD-WZA150W-NW.....	451
LD-MISS7WOS-NB.....	273	LD-ORW07W-NBP-10.....	108	LD-SRA18WB-NB.....	182	LD-XARO18W-30.....	80
LD-MOD4060-NB.....	68	LD-ORW13W-CBP.....	107	LD-SRA18WC-NB.....	182	LD-XARO36W-30.....	80
LD-MOD4060UGR-NB.....	68	LD-ORW13W-CBP4.....	107	LD-SRW12WKW-NB.....	105	LD-XARO48W-30.....	80
LD-MOD12030UGR-NB.....	68	LD-ORW13W-CBP-10.....	108	LD-SRW12WOK-NB.....	105	LD-Z3CSCB-53.....	442
LD-MOON12W-NB.....	88	LD-ORW13W-NBP.....	107	LD-SRW18WKW-NB.....	105	LD-ZAC6WDE-RGB.....	453
LD-MOON18W-NB.....	88	LD-ORW13W-NBP4.....	107	LD-SRW18WOK-NB.....	105	LD-ZAS09WEC-30.....	447
LD-MZ12WKW-NB.....	111	LD-ORW13W-NBP-10.....	108	LD-SRW24WKW-NB.....	105	LD-ZAS15WEC-30.....	447
LD-MZ12WOK-NB.....	111	LD-ORW19W-CBP.....	107	LD-SRW24WOK-NB.....	105	LD-ZAS20WEC-30.....	447

LD-ZAS24PRO16W-30.....	448	LT-LK3WBL-60.....	164	OP-OPRKWT-21.....	228	OS-AVB8090KW1-00.....	190
LD-ZAS24PRO33W-30.....	448	LT-LKSZ3W-60.....	164	OP-OPROK1-20.....	229	OS-AVB8090KW1-10.....	190
LD-ZAS24PRO54W-30.....	448	LZ-25MM00-00.....	391	OP-OPROK1-80.....	229	OS-AVB8090OK1-00.....	190
LD-ZAS24PRO80W-30.....	448	LZ-40MM00-00.....	391	OP-OPROKR-10.....	228	OS-AVB8090OK1-10.....	190
LD-ZAS30WEC-30.....	447	LZ-60MM00-00.....	391	OP-OPROKR-21.....	228	OS-AVB80160KW2-00.....	192
LD-ZAS60WEC-30.....	447	LZ-100MM0-00.....	391	OP-PADRK3-01.....	223	OS-AVB80160KW2-10.....	192
LD-ZAS75W-30.....	448	LZ-160MM0-00.....	391	OP-PADRK3-10.....	223	OS-AVB80160OK2-00.....	192
LD-ZAS150-NW.....	450	LZ-250MM0-00.....	391	OP-PADRK3-21.....	223	OS-AVB80160OK2-10.....	192
LD-ZAS350-NW.....	450	LZ-AKZ312-10N.....	469	OP-PADRK3-52.....	223	OS-BLND50W1-00.....	202
LD-ZASNF-12V6X12-65.....	409	LZ-AKZ612-10N.....	470	OP-PADRK3-61.....	223	OS-BLND50W1-10.....	202
LD-ZASPRO07W-30.....	449	LZ-KA2MM-10.....	468	OP-PADST3-01.....	222	OS-BLND50W2-00.....	203
LD-ZASPRO12W-30.....	449	LZ-KAPR2M-10.....	469	OP-PADST3-10.....	222	OS-BLND50W2-10.....	203
LD-ZASPRO16W-30.....	449	LZ-KOI2KO-10.....	391	OP-PADST3-21.....	222	OS-BLND50W3-00.....	203
LD-ZASPRO24W-30.....	449			OP-PADST3-52.....	222	OS-BLND50W3-10.....	203
LD-ZASPRO33W-30.....	449	<b>O</b>		OP-PADST3-61.....	222	OS-CAMD40WG9KW-00.....	218
LD-ZASPRO54W-30.....	449	OA-MALEDPAN-00.....	397	OP-PALACEDKW-10.....	232	OS-CAMD40WG9KW-10.....	218
LD-ZASPRO65W-30.....	449	OA-SALED1-08.....	144	OP-PALACEDKW-20.....	232	OS-CAMD40WG9OK-00.....	218
LD-ZASPRO80W-30.....	449	OA-SALED3-08.....	144	OP-PALACEDOK-10.....	232	OS-CAMD40WG9OK-10.....	218
LD-ZASPU15W-30N.....	451	OH-ST2500-23.....	393	OP-PALACEDOK-20.....	232	OS-COROUA-30.....	250
LD-ZFPL24W06-NB.....	83	ON-ALFAKU10-06.....	291	OP-PAST1-01.....	221	OS-CORDUA-30.....	250
LD-ZFPL48W12-NB.....	83	ON-ALFAKU10-06-MINI.....	291	OP-PAST1-02.....	221	OS-CORP36G-30.....	250
LD-ZIT600W-00.....	175	ON-ALFAO-C1W.....	292	OP-PAST1-10.....	221	OS-CORP40-30.....	250
LD-ZIT600W-01.....	175	ON-ALFAO-C2W.....	292	OP-PAST1-21.....	221	OS-CORP40G-30.....	250
LD-ZL5RGB150-00.....	407	ON-ALFAOGU10-06.....	291	OP-PAST1-30.....	221	OS-CORP80-30.....	250
LD-ZSKL15-00N.....	452	ON-ALFAOGU10-06-MINI.....	291	OP-PIREN1-00.....	214	OS-CORP80G-30.....	250
LD-ZTK8-COB.....	470	ON-BETAKGU10RK-06.....	292	OP-PIREN1-20.....	214	OS-DIEGOGU10-20.....	288
LD-ZTK8MM-02N600.....	472	ON-BETAOGU10RK-06.....	292	OP-PIREN2-00.....	214	OS-DIEGOGU10-80.....	288
LD-ZTK10MM-02N.....	472	OP-ALSKW-00.....	240	OP-PIREN2-20.....	214	OS-DRAGO14-00.....	201
LD-ZTKS8MM-02N.....	472	OP-ALSKW-10.....	240	OP-PIREO1-20.....	217	OS-DRAGO14-10.....	201
LD-ZTKT8MM-02N600.....	471	OP-ALSKW-52.....	240	OP-PIREO1-81.....	217	OS-DRAGO14-80.....	201
LD-ZTKT10MM-02N.....	471	OP-ALSOK-00.....	240	OP-PIREO2-20.....	217	OS-DRAGO18-00.....	201
LD-ZTKTRGB-04N.....	471	OP-ALSOK-10.....	240	OP-PIREO2-81.....	217	OS-DRAGO18-10.....	201
LD-ZTL8-COB.....	470	OP-ALSOK-52.....	240	OP-PRAN5-01.....	226	OS-DRAGO18-80.....	201
LD-ZTL8MM-02N600.....	471	OP-ARIKW-11.....	235	OP-PRAN5-02.....	226	OS-ESOE2711-20.....	268
LD-ZTL10MM-02N.....	471	OP-ARIKW-13.....	235	OP-PRAN5-21.....	226	OS-ESOE2711-80.....	268
LD-ZTL82MAMP-COB.....	470	OP-ARIKW-22.....	235	OP-PRAN5-30.....	226	OS-FRG20W2-00.....	204
LD-ZTL82M-COB.....	470	OP-ARIKW-23.....	235	OP-PRAN6-01.....	227	OS-FRG20W2-00-MINI.....	204
LD-ZTLRGB-04N.....	471	OP-ARIKW-11.....	235	OP-PRAN6-02.....	227	OS-FRG20W2-10.....	204
LD-ZTLS8MM-02N.....	472	OP-ARIKW-13.....	235	OP-PRAN6-21.....	227	OS-FRG20W2-10-MINI.....	204
LD-ZTLS8MMAMP-02N.....	472	OP-ARIKW-22.....	235	OP-PRAN6-30.....	227	OS-GRAODA-00.....	262
LD-ZTLS82M-2N.....	472	OP-ARIKW-23.....	235	OP-PROD3-01.....	224	OS-GRAOOP-00.....	262
LD-ZWND6W-10.....	452	OP-ARIKW-23.....	235	OP-PROD3-02.....	224	OS-GRAOUA-00.....	262
LD-ZWND12-10.....	452	OP-AURKWB-10.....	236	OP-PROD3-21.....	224	OS-GRA31P-00.....	262
LD-ZZAS07PROKD6.....	449	OP-AURKWC-00.....	236	OP-PROD3-30.....	224	OS-GRAZIEGU10-01.....	290
LD-ZZAS12PROKD6.....	449	OP-AURKWS-52.....	236	OP-PROD4-01.....	225	OS-GRAZIEGU10-20.....	290
LD-ZZAS16PROKD6.....	449	OP-AUROKB-10.....	236	OP-PROD4-02.....	225	OS-HERZW1-00.....	153
LD-ZZAS24PROKD6.....	449	OP-AUROK-00.....	236	OP-PROD4-21.....	225	OS-IBLO60-00.....	157
LD-ZZAS33PROKD6.....	449	OP-AUROKS-52.....	236	OP-PROD4-30.....	225	OS-IBKR060-00.....	157
LD-ZZASG18KWD6.....	452	OP-CANKWB-10.....	230	OP-RUBIOKW1-00.....	242	OS-ISUES111-00.....	216
LK-LIVIA-OP.....	173	OP-CANKWC-00.....	230	OP-RUBIOKW1-10.....	242	OS-ISUES111-10.....	216
LK-OMEGA-OP.....	170	OP-CANOKB-10.....	230	OP-RUBIOKW2-00.....	242	OS-ITL12WKW-LED.....	98
LK-PANELX4-00.....	74	OP-CANOKC-00.....	230	OP-RUBIOKW2-10.....	242	OS-ITL12W-LED.....	98
LK-VILANA-00.....	173	OP-ELVAOBB-10.....	239	OP-SALKW-10.....	231	OS-ITL16W-LED.....	98
LP-BENFICA2-00.....	312	OP-ELVAOBC-11.....	239	OP-SALOK-10.....	231	OS-KACROO-00.....	158
LP-BENFICA2-10.....	312	OP-ELVAOCC-00.....	239	OS-AERD20W-00.....	188	OS-KAG508-10.....	163
LP-BENFICA2-80.....	312	OP-ELVAOCM-03.....	239	OS-AERD20W-10.....	188	OS-KAM060-00.....	160
LP-VAS8W-10-DEC.....	308	OP-KERLKW-00.....	238	OS-ARIKW-11.....	200	OS-KAM060-10.....	160
LP-VEN20W-10.....	313	OP-KERLKW-10.....	238	OS-ARIKW-13.....	200	OS-KAN527-24.....	163
LP-VEN20WO-00.....	313	OP-LINTOK-00.....	238	OS-ARIKW-22.....	200	OS-KAY060-00.....	160
LP-YORK10W-00-DEC.....	310	OP-LINTOK-10.....	238	OS-ARIKW-23.....	200	OS-KAY060-10.....	160
LP-YORK10W-10-DEC.....	310	OP-LINTOK-52.....	238	OS-ARIKW-11.....	200	OS-KEMIOUA-30.....	254
LT-LA8WT2-60.....	165	OP-MAROK-02.....	234	OS-ARIKW-13.....	200	OS-KEMIP40-30.....	254
LT-LB3WT4-60.....	165	OP-MAROK-10.....	234	OS-ARIKW-22.....	200	OS-KEMIP40G-30*.....	254
LT-LB6WT2-60.....	164	OP-OPRKW1-20.....	229	OS-ARIKW-23.....	200	OS-KEMIP80-30.....	254
LT-LB8WT6-60.....	165	OP-OPRKW1-80.....	229	OS-ARIKW-11.....	200	OS-KERTOUA-30.....	252
LT-LC6WT3-60.....	163	OP-OPRKWT-10.....	228	OS-ARIKW-13.....	200	OS-KERTP40-30.....	252







Ce catalogue de produits a été préparé par GTV Pologne. Grâce au développement constant de ses produits et afin de respecter les exigences du marché et légales, GTV Pologne se réserve le droit d'introduire des changements dans la gamme de produits présentée. La présente publication ne constitue pas une offre au sens du code civil. Les vrais produits peuvent différer des exemples de photographies et dessins de la publication. GTV Pologne se réserve le droit d'apporter des modifications et des erreurs d'impression.

Este catálogo de productos ha sido elaborado por GTV Poland. Mediante el perfeccionamiento continuo de su oferta, que cumple con las exigencias del mercado y de carácter legal, GTV Poland se reserva el derecho de a introducir cambios en la oferta de productos. La publicación presentada no es una oferta según lo establecido en el Código Civil. Los productos reales pueden diferir de las fotos e imágenes aquí presentadas. GTV Poland se reserva el derecho a cambios y errores de impresión.

Dieser Produktkatalog wurde von GTV Poland vorbereitet. Wegen der ständigen Entwicklung unseres Sortiments zum Zwecke seiner Anpassung an die Markt- und Rechtsanforderungen behält GTV Poland sich das Recht vor, das im Katalog dargestellte Sortiment zu ändern. Der Katalog stellt kein Angebot im Sinne des polnischen Zivilgesetzbuches dar. Die tatsächlichen Produkte können von den im Katalog enthaltenen Fotos und Zeichnungen abweichen. GTV Poland behält sich das Recht auf Änderungen und Druckfehler vor.

Katalog proizvoda pripremiło je poduzeće GTV Poland. Kroz trajno poboljšavanje svoje ponude, suglasno pravnim i tržišnim uvjetima, GTV Poland zadržava pravo uvođenja promjena u predstavljenom asortimanu. Predstavljeno izdanje prema Gradanskom zakonu ne tretira se kao ponuda. Realni proizvodi mogu se razlikovati od slika i crteža u katalogu. GTV Poland zadržava pravo izmjene sadržaja i tiskarske pogreške.

# GTV

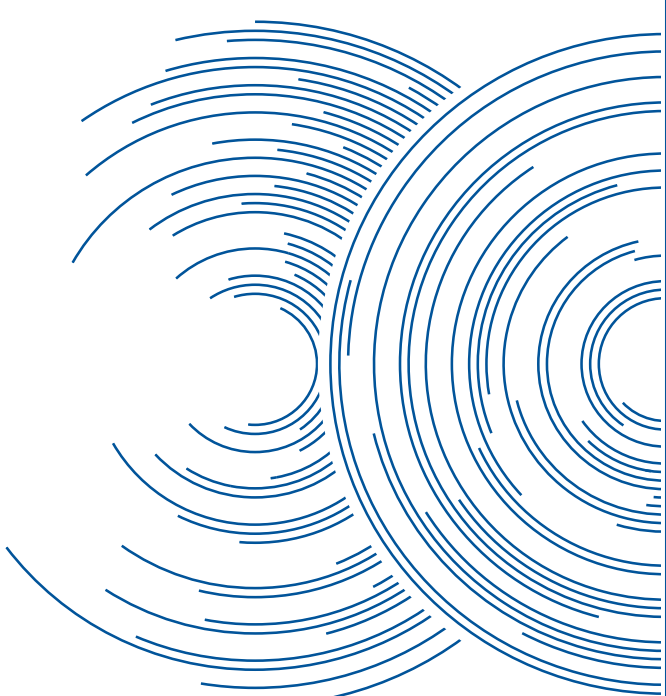

ul. Przejazdowa 21  
05-800 Pruszków  
Poland

 +48 22 44 47 595

 +48 22 44 47 366  
+48 22 44 47 287

 +48 22 44 47 394

 +48 22 44 47 379

 +420 591 160 091

  
  
 +48 22 44 47 338

  
  
  
  
 +48 22 44 47 552

  
  
  
 +48 22 4447 251

 GTV Croatia d.o.o.  
ul. Roberta Frangeša Mihanovića 9,  
10110 Zagreb, Hrvatska  
+ 385 1 798 8089

 GTV Czech Distribution s.r.o.  
CTPark Ostrava, Na Rovince 879  
720 00 Ostrava-Hrabová  
Česká republika  
+420 591 160 091  
objednavky.ostrava@gtv.com.pl

 GTV España Herrajes e Iluminación, S.L.  
Avenida Aragón 30, Planta 8  
46021 Valencia (España)  
+ 34 961 134 441  
+ 48 22 44 47 377  
gtv@gtv.es

fax: +48 22 444 75 01  
e-mail: [oswietlenie@gtv.com.pl](mailto:oswietlenie@gtv.com.pl)  
[east.lighting@gtv.com.pl](mailto:east.lighting@gtv.com.pl)  
[www.gtvdecor.com](http://www.gtvdecor.com)  
Follow us on

