

ISOLED®

CUSTOMISED LIGHT SOLUTIONS

LED lighting systems for sports fields and ski slopes

INDOOR AND OUTDOOR



**FLOOD
LIGHT**
BY ISOLED

DE

GERMANY
www.isoled.info/de/flutlicht

AT

AUSTRIA
www.isoled.info/at/flutlicht

CH

SWITZERLAND
www.isoled.info/ch/flutlicht

FLOOD LIGHT

BY ISOLED



Personal consultation



Individual light planning



Project full service

TABLE OF CONTENTS

3	Convert now	11	Alpine Ski Indoor/Outdoor
4	We realize your project with you!	12	Other applications
4	Areas of application	13	Product specifications
6	Standards and Photometric Basics	14	Product range
7	Subsidies	16	Light cone of our LED floodlights
8	Requirements - sports fields and ski slopes	17	Dimensions luminaires
9	Football Outdoor	18	Mounting variants transformer
10	Tennis Outdoor	19	Light poles



Standards and Photometric Basics

Page 6



Requirements

Page 8



Subsidies

PAGE



CONVERT NOW

ISOLED® supports you from the light calculation to the commissioning of your lighting system



OPTIMIZATION OF THE VISUAL INFORMATION INTAKE DURING THE SPORTS EVENT



MAINTENANCE OF VISUAL PERFORMANCE



CREATION OF A PLEASANT AND INVITING VISUAL AMBIENCE



ACHIEVING OPTIMAL VISUAL CONDITIONS (LIGHT, DARK, COLOUR CONTRASTS)



LIMITATION OF DISTURBING AND SCATTERED LIGHT (LIGHT POLLUTION, -WASTE)



ILLUMINATION OF THE MAIN AREA AS UNIFORM AS POSSIBLE (RELEVANT PLAYING AREA)

ISOLED® FLOODLIGHT TOP LED LIGHT QUALITY

- High contrast color reproduction
- Asynchronous beam angle - avoidance of stray light
- Service life
- 5 years Warranty

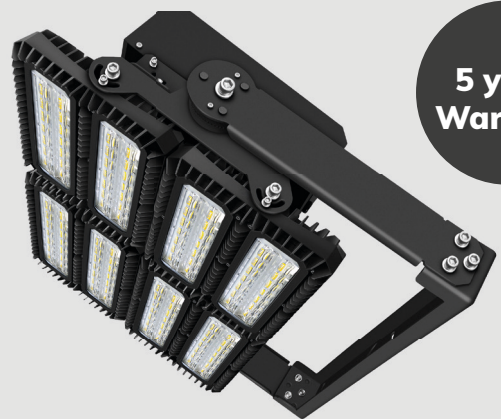

**5 years
Warranty**



30 - 50% Subsidies

We inform you about possible subsidies in DE, AT and CH!



Project Full Service

We accompany you from the light calculation over the project completion up to the start-up of your new LED lighting system.



Top LED light quality

Excellent, area-wide illumination with the floodlights from ISOLED.

WE REALIZE YOUR PROJECT WITH YOU!

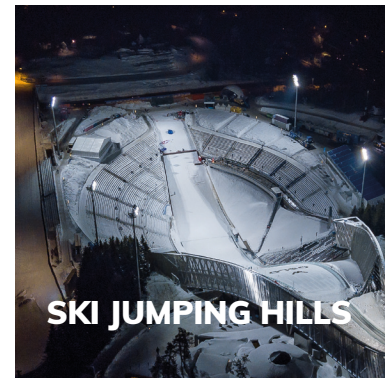
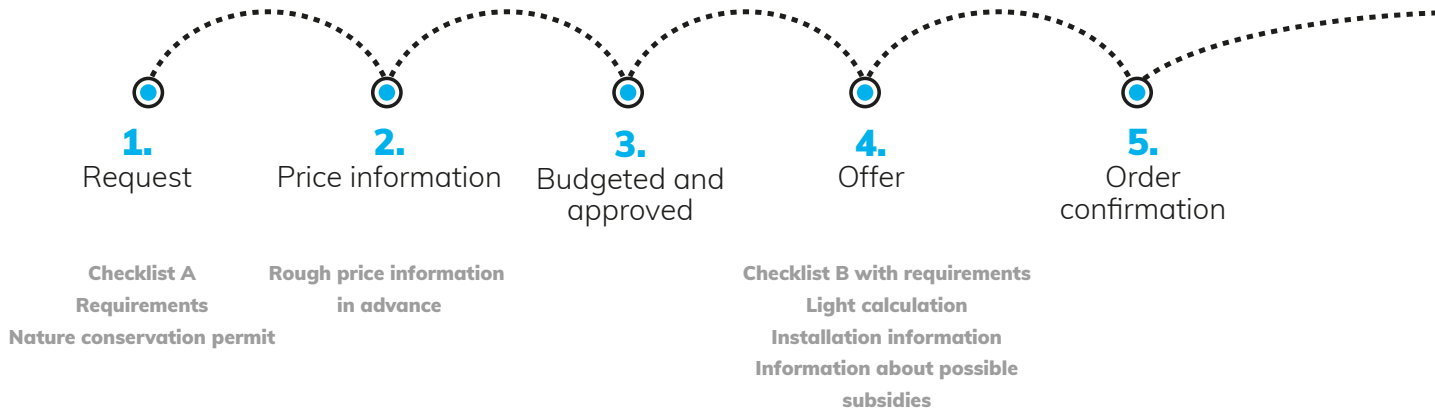

Project Full Service

We accompany you from the lighting planning to the project completion to the commissioning of your new LED lighting system. These articles are used for customer-specific project lighting solutions.

WE ADVISE YOU

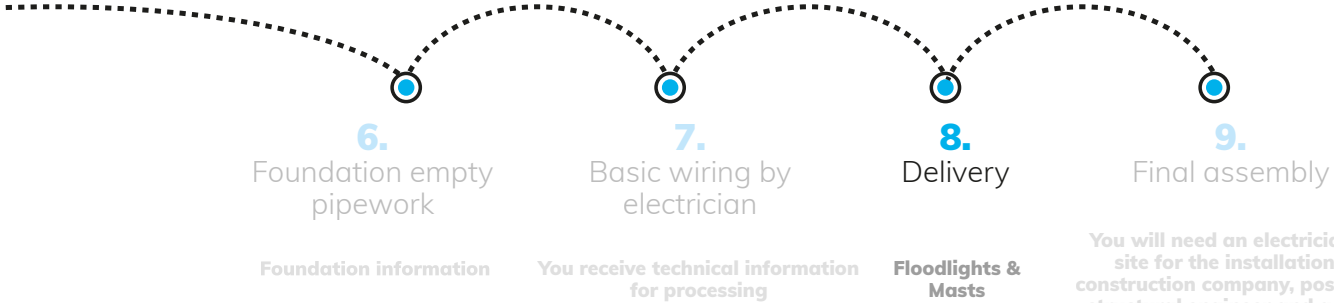

You will need an electrician on site for the installation, a construction company, possibly a structural engineer and a fitter for the installation of the floodlights on trusses (risers are required)
Carrying out a lighting performance check

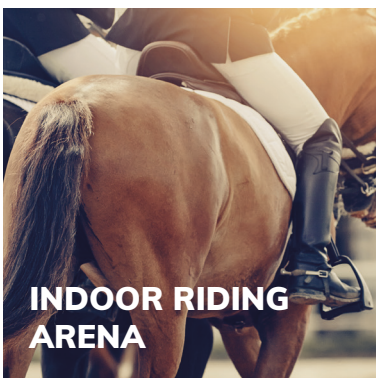
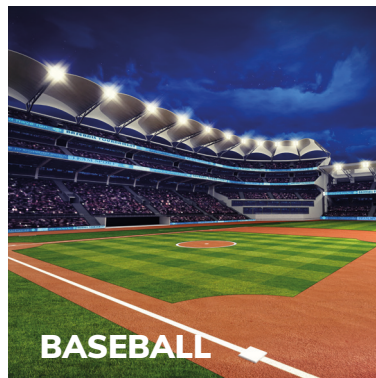
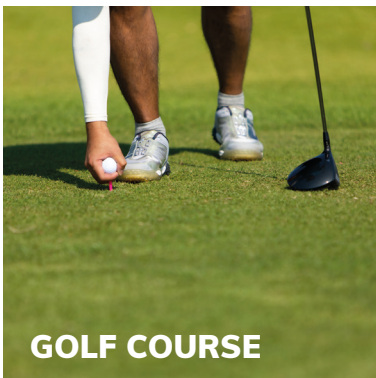

STANDARDS AND PHOTOMETRIC BASICS



OPTIMIZATION OF THE VISUAL INFORMATION INTAKE DURING THE SPORTS EVENT



MAINTENANCE OF VISUAL PERFORMANCE



CREATION OF A PLEASANT AND INVITING VISUAL AMBIENCE



ACHIEVING OPTIMAL VISUAL CONDITIONS
(LIGHT, DARK, COLOUR CONTRASTS)



LIMITATION OF DISTURBING AND SCATTERED LIGHT
(LIGHT POLLUTION, -WASTE)



ILLUMINATION OF THE MAIN AREA AS UNIFORM AS POSSIBLE
(RELEVANT PLAYING AREA)

LIGHT ACCORDING TO STANDARDS

DIN EN 12193 (2019-06) contains specifications for the lighting of sports facilities with the aim of enabling good visual conditions for athletes, referees, spectators and television and film recordings.

DISTRIBUTION OF ILLUMINANCE

Regarding uniformity, we consider the lowest (E_{min}), the average (E_{av}) as well as the maximum (E_{max}) horizontal illuminance measured in the unit LUX at height 0m. The light is uniformly distributed if the illuminances at the evaluation points are similar. The uniform distribution of light is specified as

- U₂ horizontal: ratio of minimum to average illuminance
- U₁ horizontal: ratio of minimum to maximum illuminance

The grid of evaluation or measurement points is, for example, 1/20 in length and width for football pitches and 1/10 for tennis courts.

GLARE FACTOR - GLARE RATING

What the UGR (Unified Glare Rating) method is for office lighting, the GR (Glare Rating) model of the International Commission on Illumination CIE is for outdoor installations.

The brightness of the illuminated sports surface is related to the brightness of the light sources.

The calculated ratio ranges on a scale from ten for "no glare" to 90 for "intolerable glare" (see standard EN 12464-2).

COLOR RENDERING

The colour rendering index CRI Ra represents how true-to-life colours are reproduced under artificial lighting. The reference value here is sunlight with a CRI of 100.

LIGHT COLOR

The light colour of a lamp describes the inherent colour of the emitted light. It is specified in Kelvin and ranges from warm white with 2700K to 3000K, neutral white from 4000K to 4500K, cool white from 5000K to 6000K.

The colour temperature has a high influence on the experienced mood. In outdoor facilities, the use of "too cold" light with a high blue content should be avoided to protect insect species that are attracted to it.

LUMINOUS FLUX

The amount of light emitted by a luminaire is expressed in lumens. This value does not change regardless of the beam angle or distance.



MAINTENANCE FACTOR - USEFUL LIFE

The lighting level of a lighting installation decreases during its service life as a result of

- Ageing of the luminaires, their control gear and lenses (clouding)
- Contamination of the lamps and reflectors
- Aging (darkening, reduced reflection) of illuminated surfaces.

The maintenance factor is a numerical value that defines the ratio of a maintenance value to the new value of a (physical) quantity. The maintenance intervals must be agreed between the planner and the operator.

A specified useful life in hours is that design period during which y % (By) of a group of LED luminaires of the same type in operation under test conditions exhibit a parametric fault.

The planning shall be carried out in such a way that the original specifications (taking into account light degradation, etc.) can be met by the end of the expected period of use.

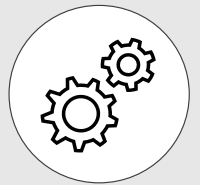

SUBSIDIES

30 - 50 % Subsidies

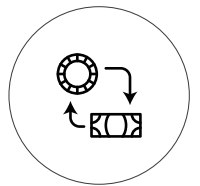

Austria

National financing subsidies for energy-efficient LED lighting concepts for indoor and outdoor facilities are examined and awarded in Austria by Kommunalkredit Austria AG. (www.kommunalkreditinvest.at)

In addition, there are subsidies from the federal states, such as the Tyrol climate subsidy, which can contribute to financial relief when investing in LED lighting solutions. Further information can be found at <https://www.umweltfoerderung.at/landesfoerderungen.html>.

Sports clubs in Austria also find support in their provincial and federal associations as well as in their home communities.

Germany

The German Federal Ministry for the Environment (BMU - www.bmu.de) offers with its large funding program within the framework of the national climate protection initiative not only companies but also associations financial support for the investment in sustainable LED lighting solutions.

Further subsidies are granted at federal state level. The federal state of Bavaria, for example, provides funding in particular to financially weak municipalities for the construction or modernization of sports facilities.

Clubs can also contact the regional state and national federations for individual subsidies, depending on the sport and division.

Switzerland

Funding program for lighting retrofits at athletic facilities

effeSPORT is a national funding programme of the Lighting Industry Association FVB for the refurbishment of lighting in sports facilities.

The replacement of classic, powerful light sources with LEDs is compensated with an amount of CHF 70 to 350 per light.

Detailed information at www.effeSPORT.ch

Sports fields and ski slopes

Outdoor & Indoor

**5 YEARS
WARRANTY**

Requirements

Top LED light quality for sports and leisure

Dynamics, speed, different game situations, rapidly changing slope conditions, the individual visual performance of the athletes and much more place special demands on optimal LED lighting.

Athletes must be able to get used to the light in their environment very quickly. They need sufficient illuminance (lux) on the surface they play on or ride on in order to be able to practice their sport successfully and, above all, as injury-free as possible.

The operator of the sports facility or ski slope defines the lighting class of the LED lighting solutions to be installed, which must be achieved due to the sports operation.



HIGH CONTRAST COLOR REPRODUCTION



HIGH QUALITY OF LIGHT



EXCELLENT, AREA-WIDE ILLUMINATION OF THE PLAYING FIELD
(MINIMUM LIGHT SCATTERING LOSSES)

LEVEL OF COMPETITION	LIGHTING CLASS		
	I	II	III
International/National	X		
Regional	X	X	
Local	X	X	X
Training		X	X
Recreation/School Sports			X

 Available in our assortment

 Floodlightsystems of the **Lighting class I** are possible on request according to individual planning

All specifications and technical data are subject to change without notice of the standards and classifications. No assumption of liability.

WE ADVISE YOU

Highlights of the floodlights



High end LED chips of the latest generation



Maintenance-free luminaire body of protection class IP66 made of high-quality aluminium and impact-resistant PC (IK10)



Intelligent thermal management for long life/operating time



Reliable brand transformer from Meanwell | With overvoltage protection



High-performance luminaires of efficiency class A++



Sustainable binning (SDCM < 3) for uniform light quality





OUTDOOR FACILITY	MAIN AREA / TOTAL AREA		
	Length m	Width m	Calculation grid
FOOTBALL	105 / 113	70 / 78	21 x 15 measuring points
SMALL PITCH FOOTBALL	35 / 44	19 / 24	15 x 9

Permissible lighting class	average horizontal illuminance		Ratio min. to average illuminance		Glare rating GR	Colour rendering CRI Ra
I	min. 500 Lux	=> 75%	min. 0,7	=> 0,5	max. 55	min. 70
II	min. 200 Lux		min. 0,6		max. 55	min. 60
III	min. 75 Lux		min. 0,5		max. 55	min. 60

φ total		P total			
4.039.952 lm		28.800 W			
Pcs.	Item no.	Item name	P	φ	Luminous efficacy
8	114626	ISOLED floodlight	900 W	125.000 lm	140.7 lm/W
16	114628	ISOLED floodlight	1.350 W	189.997 lm	140.6 lm/W

4 masts with 238 kg load each - designed for wind zone 2 Mast height 15 m (outriggers left and right at least 1 m and 1.5 m respectively)

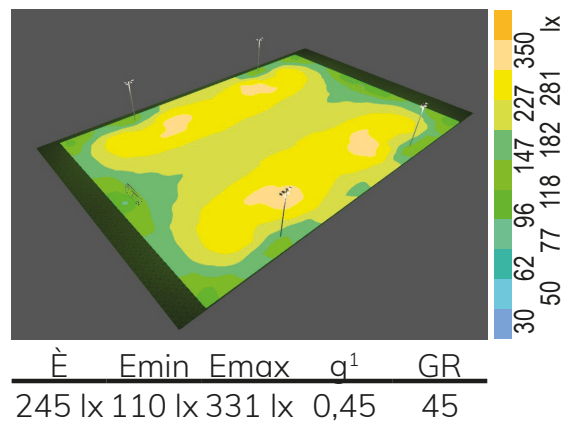
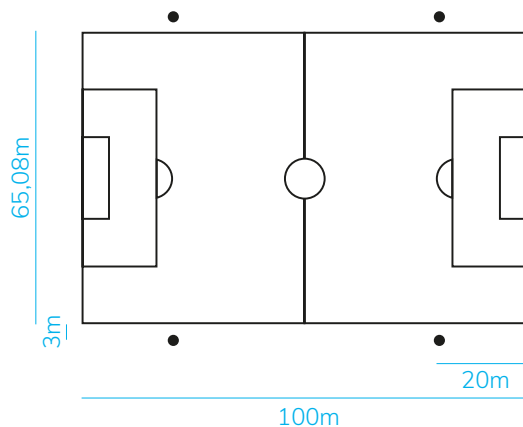

*For the application example presented here, a requirements profile based on the standardized specifications according to Light and lighting - Sports facility lighting; DIN EN 12193:2019-07 (Germany EN 12193:2018) was used.



TENNIS | OUTDOOR

OUTDOOR FACILITY	MAIN AREA / TOTAL AREA		
	Length m	Width m	Calculation grid
TENNIS	30 / 36	15 / 18	15 x 7 measuring points

Permissible lighting class	average horizontal illuminance	Ratio min. to average illuminance	Glare rating GR	Colour rendering CRI Ra		
I	min. 500 Lux	=> 75%	min. 0,7	=> 0,5	max. 50	min. 70
II	min. 300 Lux		min. 0,7		max. 50	min. 60
III	min. 200 Lux		min. 0,6		max. 55	min. 60

φ total		P total			
1.519.484 lm		10.800 W			
Pcs.	Item no..	Item name	P	φ	Luminous efficacy
4	114628	ISOLED floodlight	1.350 W	189.997 lm	140.7 lm/W
4	114629	ISOLED floodlight	1.350 W	189.874 lm	140.6 lm/W

4 masts with 86 kg load each - designed for wind zone 2 Mast height 15 m (outriggers left and right min. 0.7 m)

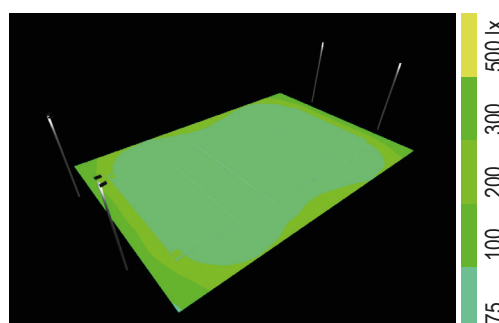
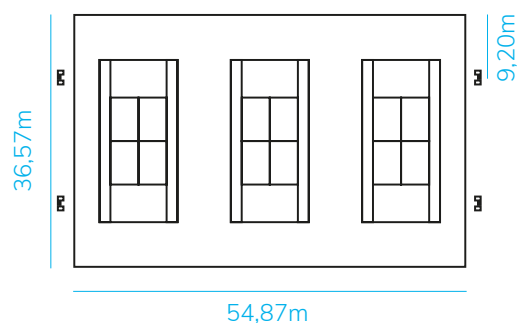

\bar{E}	E_{min}	E_{max}	q^1	GR
416 lx	291 lx	497 lx	0,70	32





ALPINE SKI | INDOOR/OUTDOOR

INDOOR / OUTDOOR FACILITY	REFERENCE AREA		
	Length m	Width m	Calculation grid
SKI SLOPE	e.g. 125	e.g. 17	29 x 8 measuring points

Permissible lighting class	average horizontal illuminance	Ratio min. to average illuminance	Glare rating GR	Colour rendering CRI Ra
I	min. 100 Lux	min. 0,5	max. 50	min. 70
II	min. 30 Lux	min. 0,3	max. 50	min. 60
III	min. 20 Lux	min. 0,2	max. 55	min. 60

φ total		P total			
256.056 lm		1.800 W			
Pcs.	Item no..	Item name	P	φ	Luminous efficacy
4	114624	ISOLED floodlight	450 W	64.014 lm	142.3 lm/W

4 masts with 20 kg load each - designed for wind zone 3 Mast height 8 m (outrigger not necessary)

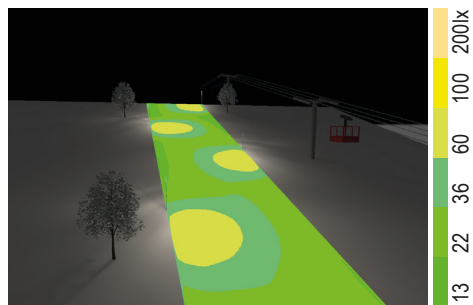
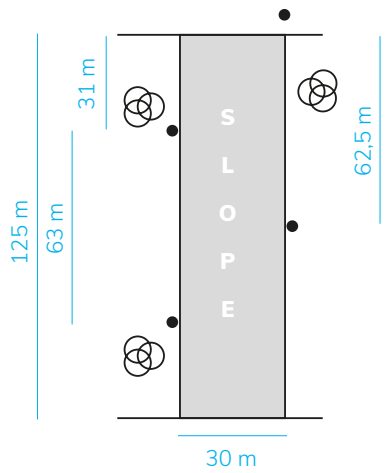

È	E _{min}	E _{max}	g ¹	GR
41,2 lx	12,3 lx	94,3 lx	0,30	50

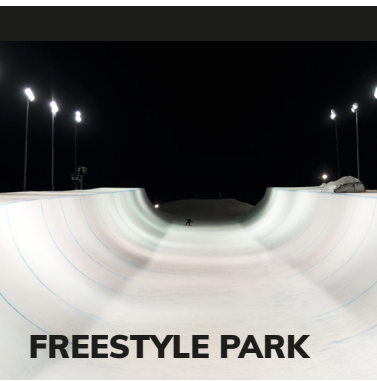

FREESTYLE PARK



LUGE AND BOBSLEIGH TRACKS



SPEEDSKATE ARENA

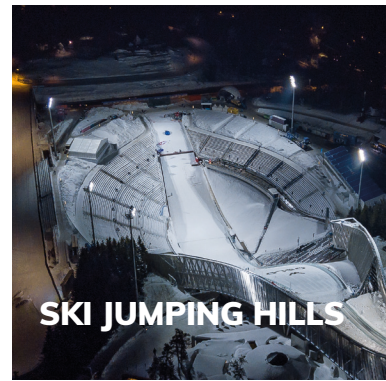

SKI JUMPING HILLS



VOLLEYBALL



ICE SPORTS FACILITIES

Further areas of application
Outdoor & Indoor
WE ADVISE YOU!



BASKETBALL



RACETRACKS



CROSS-COUNTRY SKI TRAIL

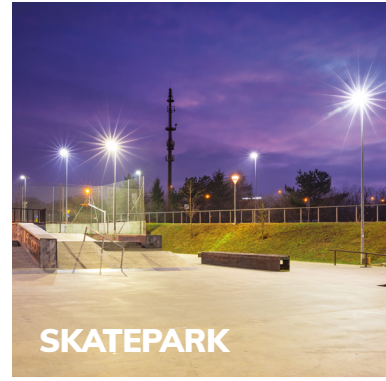

SKATEPARK



ATHLETICS



FIELD HOCKEY

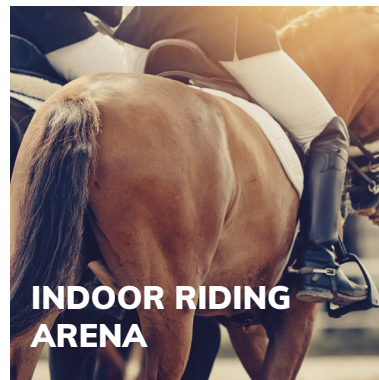

INDOOR RIDING ARENA



RUGBY PITCH

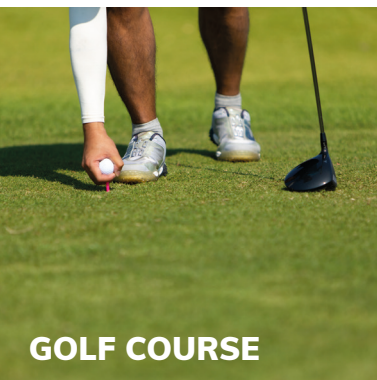

GOLF COURSE



CLIMBING HALL

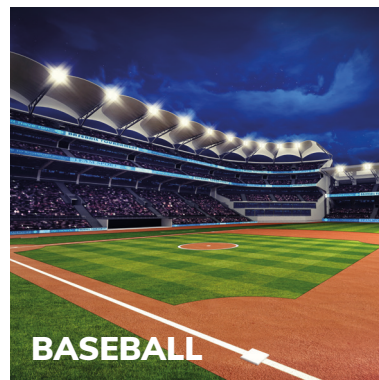

BASEBALL



BADMINTON



Product specifications at a glance

Detailed data sheets available at any time

ITEM NUMBER	114624 114625 LED floodlight 450 W	114626 114627 LED floodlight 900 W	114628 114629 LED floodlight 1,350 W
Efficiency class	A++	A++	A++
Material	Aluminium	Aluminium	Aluminium
Rated voltage/current	110 - 240 V AC	110 - 240 V AC	110 - 240 V AC
Rated power in watts	450	900	1.350
Active power in watt	450	900	1.350
Apparent power in VA	470	940	1.400
LED type	216 x SMD5050	432 x SMD5050	648 x SMD5050
Colour temperature	4.000 K	4.000 K	4.000 K
asymmetrical radiation angle	130 x 25° 130 x 40°	130 x 25° 130 x 40°	130 x 25° 130 x 40°
Lumen	64.000 (142 lm/W)	125.000 (138 lm/W)	190.000 (140 lm/W)
Candela	17.642	34.456	52.373
CRI	70	70	70
Ambient temperature	-40 - 50°	-40 - 50°	-40 - 50°
Surge protection	10 kV	10 kV	10 kV
Weight	19,20 kg incl. transformer 13,16 kg without transformer	33,30 kg incl. transformer 21,22 kg without transformer	42,80 kg incl. transformer 29,90 kg without transformer
Transformer	2 x 215V DC, 1.050mA	4 x 215V DC, 1.050mA	6 x 215V DC, 1.050mA
Useful life	up to 100.000 h	up to 100.000 h	up to 100.000 h
Protection class	IP66	IP66	IP66
Dimmable	1 - 10 V dimmable optional DALI dimmable	1 - 10 V dimmable optional DALI dimmable	1 - 10 V dimmable optional DALI dimmable
Guarantee	5 years	5 years	5 years



LED flood light 450W

450 watts | 130 x 25° / 130 x 40° | asymmetrical | variable | 1 - 10 V dimmable | neutral white | IP66



Special features:

Transformers 2 x Meanwell ELG-C
1.050 mA, incl. overvoltage protection 10 kV,
Service life 100,000 h,
Beam angle 130 x 25° or 130 x 40° asymmetrical,
Luminaire modules variable, incl. protective cable sheathing



LED flood light 900W

900 watts | 130 x 25° / 130 x 40° | asymmetrical | variable | 1 - 10 V dimmable | neutral white | IP66

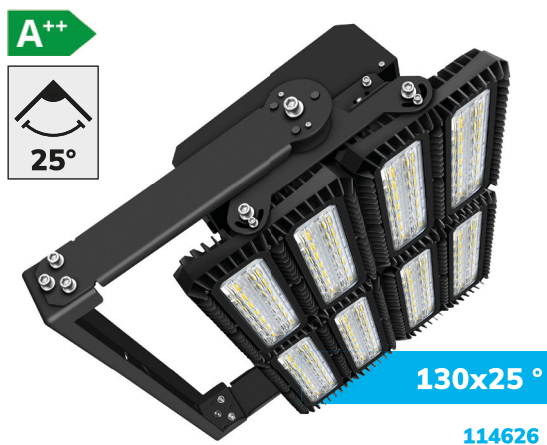

Special features:

Transformers 4 x Meanwell ELG-C
1.050 mA, incl. overvoltage protection 10 kV,
Service life 100,000 h,
Beam angle 130 x 25° or 130 x 40° asymmetrical,
Luminaire modules variable, incl. protective cable sheathing



LED flood light 1350W

1,350 watts | 130 x 25 ° / 130 x 40 ° | asymmetrical | variable | 1 - 10 V dimmable | neutral white | IP66

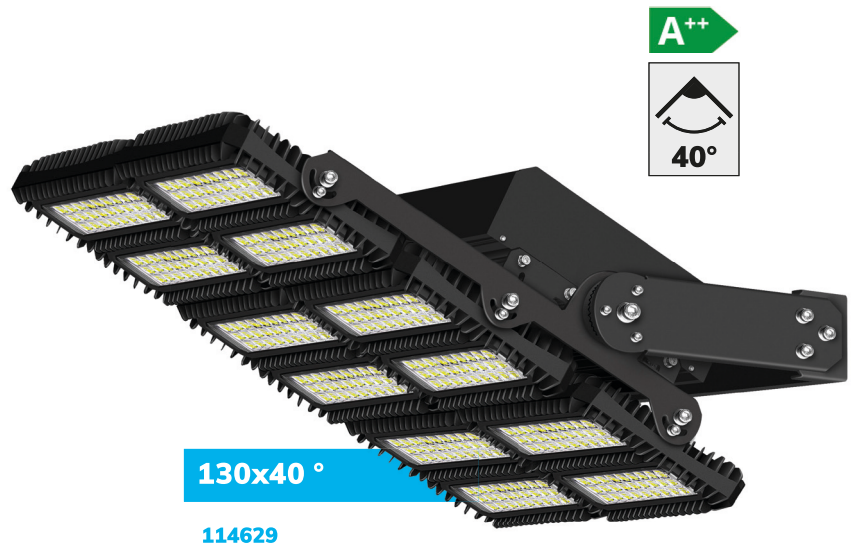
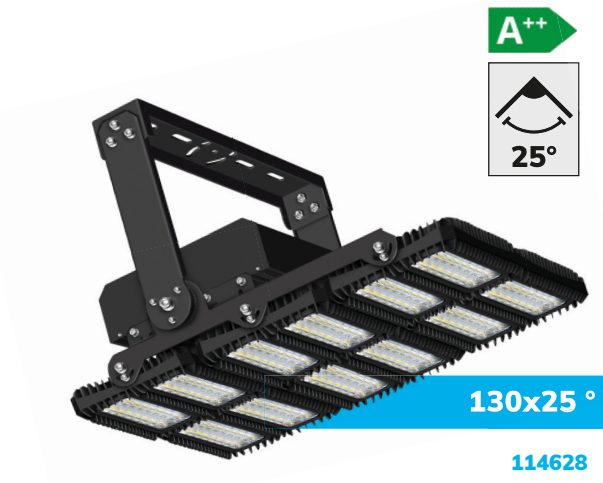

Special features:

- Transformers 6 x Meanwell ELG-C
- 1050 mA, incl. overvoltage protection 10 kV,
- Service life up to 100,000 h,
- Beam angle 130 x 25° or 130 x 40° asymmetrical,
- Luminaire modules variable, incl. protective cable sheathing

Accessories

The accessories facilitate the precise alignment of the light cone on site.



Angle bubble

For precise locking the inclination. The angle spirit level is included with every spotlight.



Alignment telescope for LED floodlights

For precise alignment of the light cone.

114859

Light cone of our LED floodlights

Above each individual LED chip of our floodlights is a highly transparent, ball-proof polycarbonate lens, which scatters the emitted light of the LED at an asymmetrical angle of 25° or 40° narrow and wide "forward" and 130° wide to the side.

can see the bundled, directed light scattering in one direction on the example of our 900W version. With symmetrically emitting luminaires, the light distribution curve would be more like an apple shape.

On the basis of the light distribution curve shown below, we

Asymmetric beam angles for more efficiency



Reduced wind load due to flat mounting of the luminaires



Avoidance of wastage | guaranteed sustainability



No dazzling effect in the spectator area or stands



Focused, concentrated light output where it is needed

**SUSTAINABILITY
GUARANTEED**

Simplifies the approval process procedure

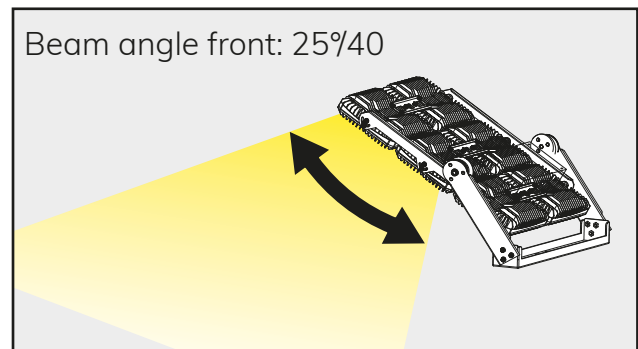
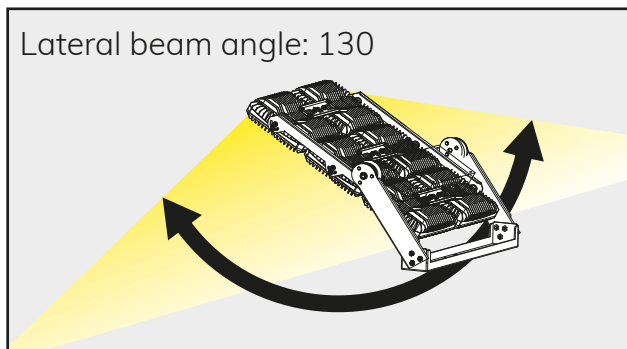

900 W 130° x 25°

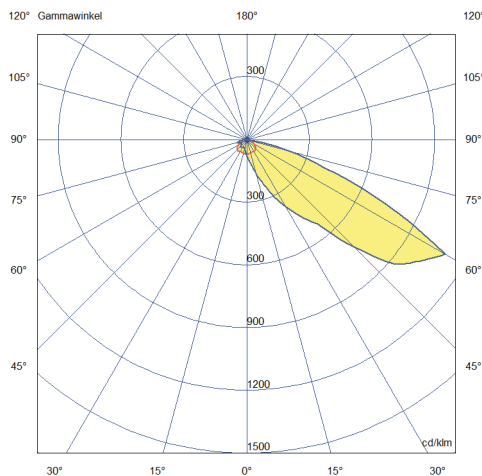

900 W 130° x 40°

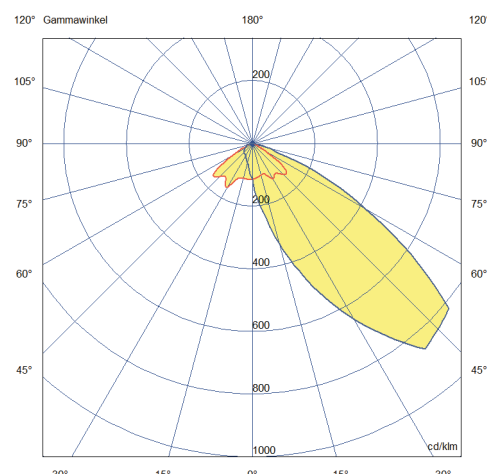

The illustrations show the light distribution curve of our lighting solutions. A light distribution curve is a visual representation of the light distribution in graphical form.



Dimensions luminaires

FLOODLIGHT 450 W

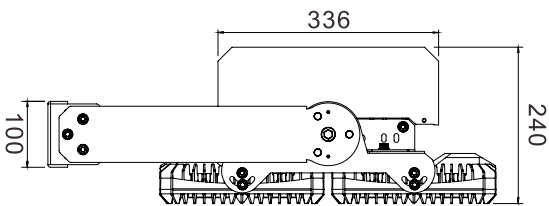
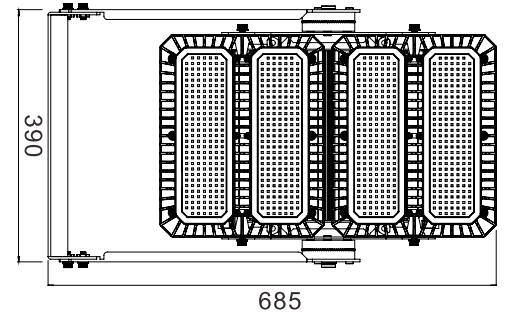

FLOODLIGHT 900 W

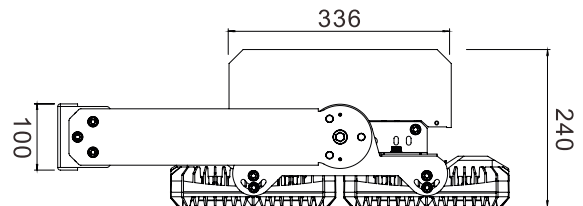
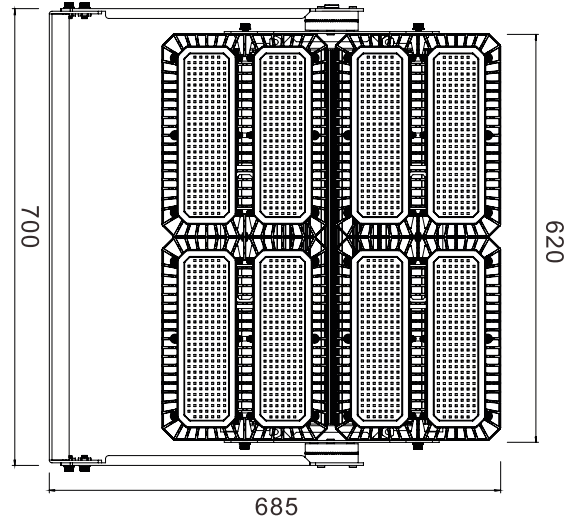

FLOODLIGHT 1.350 W

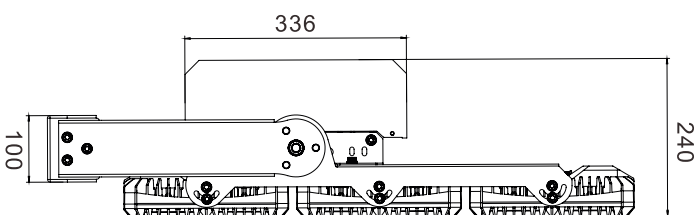
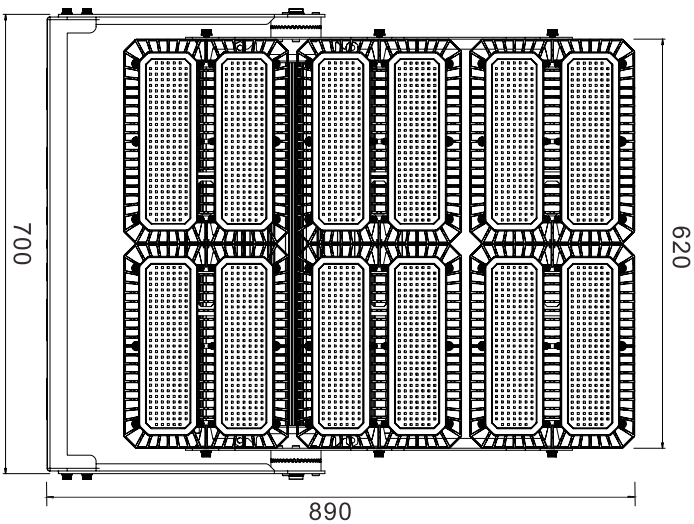

Mounting variants transformer

Integrated variant

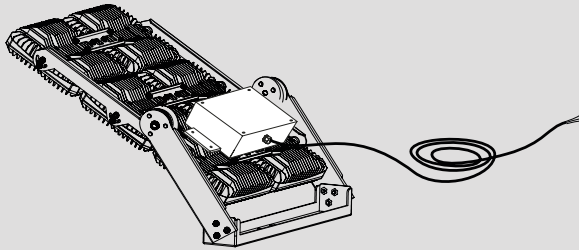

Integrated transformer box for mounting directly on the luminaire. - Waterproof connections are required.

External variant

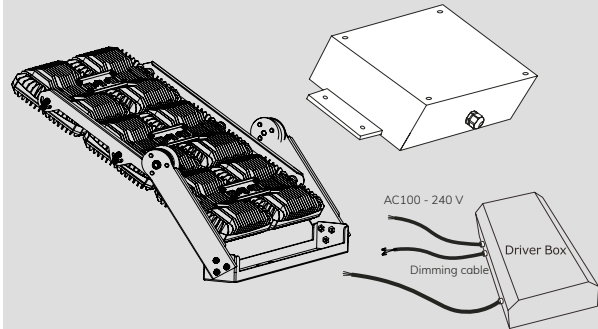

Separate transformer box for external mounting. - Waterproof connections are required.

ISOLED® Your sustainable partner

CONVERT NOW

- Highest energy efficiency and reliable performance
- Excellent luminous efficacy of up to 142 lumens per watt
- Immediately 100 % light
 - no pre/post run time for warming up or cooling down as with conventional lighting systems
 - Electronics support >30,000 switching cycles. Immediate restart possible, e.g. after power failure.
- If a driver fails, the light output of the floodlight is reduced by its power, but does not fail completely. Transformers can be replaced during operation - similar to a Raid system.

Light poles

Floodlight mast conical with traverse

The conical round light pole consists of a formed and longitudinally welded steel sheet, which is hot-dip galvanized with a minimum steel quality of S235 JR and according to DIN EN ISO 1461.

The pole is statically designed individually for the installation site and adapted for the luminaire or the number of luminaires per pole. The poles are provided with a door cut-out with inserted steel door and triangular lock made of V2A, edge length 12 mm.

The accommodation of a cable junction box is possible by means of a device bar and sliding nuts inside the mast. Two openings for cable entry are located opposite each other in the ground piece.

The light poles and trusses for outdoor installations are designed for wind zone 2, the light poles for ski slopes for wind zone 3.

The transformers can be mounted in the pole if required. Further mounting options directly on the luminaire or in a separate connection cabinet with separate cable routing.



Delivery free of freight charges for masts or more



Masts are dimensioned specifically for the project



We make foundation suggestions when purchasing ISOLED® Masts

Wind zones using the example of Germany

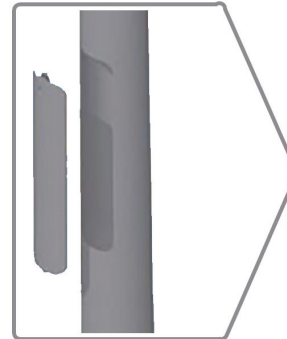

Maintenance flap for transformer and wiring / both sides
Openings for cable routing.



114735	For 1 floodlight, galvanised steel, height above ground 8 m
114733	For 2 floodlights, galvanised steel, height above ground 12 m
114734	For 2 floodlights, galvanised steel, height above ground 15 m
114732	For 3+2 floodlights, galvanised steel, height above ground 15 m
114736	For 4+2 floodlights, galvanised steel, height above ground 15 m



YOUR PARTNER

ISOLED® SINCE 2008



ISOLED® AUSTRIA

FIAI Handels GmbH
Egerbach 48
A-6334 SCHWOICH
AUSTRIA

Tel: +43 5372 219 999
Email: office@isoled.at
www.isoled.at



ISOLED® GERMANY

FIAI Trading GmbH
Hollerweg 3
D-85649 BRUNNTHAL
GERMANY

Phone: +49 228 30 43 89
85 Email: office@isoled.de
www.isoled.de



ISOLED® SWITZERLAND

Allegra Swiss GmbH
Einsiedlerstrasse 15a
CH-8834 SCHINDELLEGI
SWITZERLAND

Tel: +41 44 787 04 75

Email: info@isoled.ch
www.isoled.ch

Get an offer adapted to your requirements!

Fill out the checklist now and get your price quote immediately.

Only 3 steps to your offer:

VISIT OUR WEBSITE

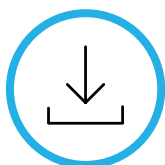

Download
and print



Fill in
and upload



Send the checklist in the contact
form as an attachment

DE GERMANY
www.isoled.info/de/flutlicht

AT AUSTRIA
www.isoled.info/at/flutlicht

CH SWITZERLAND
www.isoled.info/ch/flutlicht